

BLODGETT LAKE LAKE MANAGEMENT PLAN

MATANUSKA-SUSITNA BOROUGH
PLANNING DEPARTMENT

September 1997

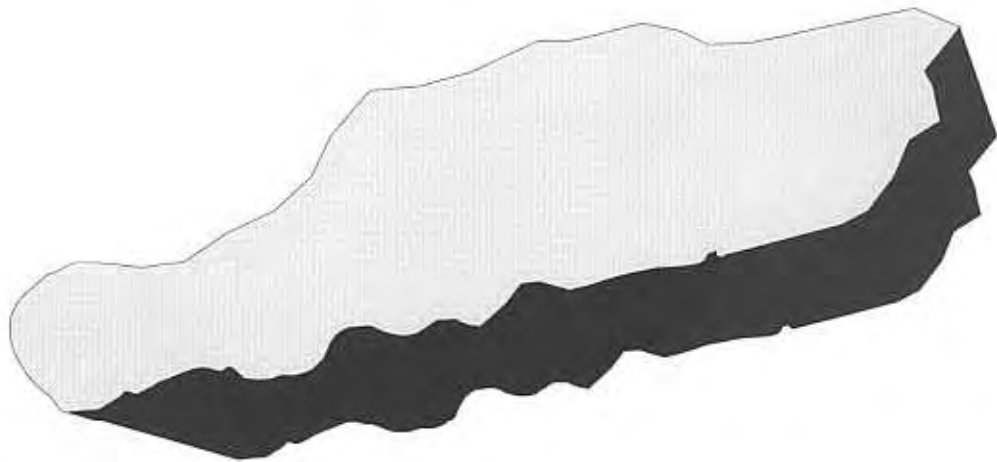

Code Ordinance

By: D. Moore
Introduced: 9/2/97
Public Hearing: 9/16/97
Adopted: 9/30/97

MATANUSKA-SUSITNA BOROUGH
ORDINANCE SERIAL NO. 97-122

AN ORDINANCE OF THE MATANUSKA-SUSITNA BOROUGH ASSEMBLY ADOPTING MSB
15.24.030(C)(13), THE BLODGETT LAKE, LAKE MANAGEMENT PLAN

WHEREAS, the Blodgett Lake, Lake Management Plan provides guidelines for the management of Blodgett Lake; and

WHEREAS, the management guidelines for Blodgett Lake were developed with input from the residents and property owners of Blodgett Lake; and

WHEREAS, the residents and property owners of Blodgett Lake are concerned about unsanitary conditions, inappropriate use of the public access, noise and water pollution and the loss of wildlife; and

WHEREAS, the residents and property owners of Blodgett Lake have developed a set of management guidelines to protect the environment and provide for the public's continued access, use, and enjoyment of Blodgett Lake; and

WHEREAS, the Matanuska-Susitna Borough Planning Commission has recommended approval of the Blodgett Lake, Lake Management Plan.

BE IT ENACTED:

Section 1. Classification. Sections 1, 2, and 4 are non-code; section 3 is of a general and permanent nature and shall become part of the borough code.

Section 2. Approval of plan. The Matanuska-Susitna Borough Assembly does hereby adopt the Blodgett Lake, Lake Management Plan.

Section 3. Amendment of subsection. MSB 15.24.030(C) is hereby amended to add a subsection (13) to read as follows:

(13) Blodgett Lake, Lake Management Plan, August 1997, adopted 1997.

Section 4. Effective date. Ordinance Serial No. 97-122 shall take effect upon adoption by the Matanuska-Susitna Borough Assembly.

ADOPTED by the Matanuska-Susitna Borough Assembly this 30th day of September, 1997.

BARBARA LACHER, Borough Mayor

ATTEST:

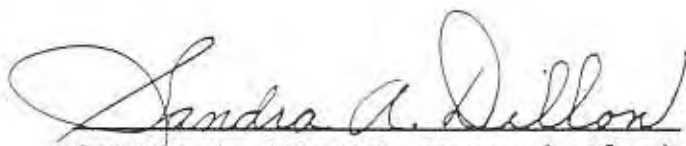
SANDRA A. DILLON, Borough Clerk

(SEAL)

MATANUSKA-SUSITNA BOROUGH
PLANNING COMMISSION RESOLUTION NO. 97-53(AM)

A RESOLUTION OF THE MATANUSKA-SUSITNA BOROUGH PLANNING COMMISSION
RECOMMENDING THAT THE ASSEMBLY ADOPT THE BLODGETT LAKE, LAKE
MANAGEMENT PLAN

WHEREAS, The Blodgett Lake, Lake Management Plan was developed with input from the residents and property owners of Blodgett Lake; and

WHEREAS, the residents and property owners of the Blodgett Lake area are concerned about unsanitary conditions, loss of wildlife and wildlife habitat, noise, erosion and protection of the quiet residential character of the Lake; and

WHEREAS, the residents and property owners of the Blodgett Lake area have developed a set of management guidelines to protect the public health, safety and welfare; and

WHEREAS, the residents and property owners of the Blodgett Lake area have developed a set of management guidelines to protect the Lake's environment and wildlife; and

WHEREAS, the Blodgett Lake, Lake Management plan provides for continued public access, use and enjoyment of Blodgett Lake.

NOW THEREFORE BE IT RESOLVED, that the Planning Commission of the Matanuska-Susitna Borough recommends that the Assembly adopt the Blodgett Lake, Lake Management Plan; and

BE IT FURTHER RESOLVED, that the Planning Commission of the Matanuska-Susitna Borough recommends that the Assembly amend the plan to include prohibition of jetskis.

ADOPTED by the Matanuska-Susitna Borough Planning Commission this 8 day of September, 1997.

TIMOTHY L. ANDERSON, Chair

ATTEST:



PRISCILLA M. GOFF, Planning Clerk
(SEAL)

Table of Contents

	Page
1. Introduction	1
1.1 Purpose	1
1.2 Approaches to Lake Management	1
1.3 Process	2
1.4 Ponds, Lakes, and Reservoirs	3
1.5 Lake Lifespan	3
1.6 General Lake Issues and Concerns	4
1.7 Blodgett Lake Issues and Concerns	5
2. Inventory of Existing Conditions	5
2.1 Location	5
2.2 Land Ownership	5
2.3 Existing Plans	6
State	6
Borough	6
2.4 Existing Regulations - Public	7
Federal	7
State	7
Borough	8
2.5 Present Lake Usage	10
2.6 Lake Characteristics	10
3. Goals	10
3.1 Water Quality	11
3.2 Recreation and Residential Character	11
3.3 Wildlife	11
4. Management Issues, Alternatives, and Recommendations	11
4.1 Wildlife	11
4.2 Noise	13
5. Implementation	14

List of Figures

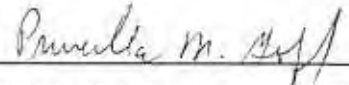
- Figure 1: Location Map
- Figure 2: Land Ownership Map
- Figure 3: Meadow Lakes Community Council Boundary
- Figure 4: General Setback Requirements and Lot Size Requirements

Appendix #1: Bird nesting area buoys, Loon Alert! and Steer Clear! posters

1 Introduction

1.1 Purpose

Lake management plans are developed for a variety of purposes. Most often lake front property owners request management plans because increased development or the provision of new public access brings about increased lake usage and a corresponding increase in user conflicts. As more people use a lake, conflicts among users may occur, bird nesting sites (especially loons and grebes) may be disturbed, environmental degradation may occur, and the overall quality of the experience may decline. The most often cited complaints are noise generated from watercraft during the evening and night hours and inappropriate use of public access points. A lake management plan seeks to present policies and strategies which attempt to balance the various demands placed upon a lake, solve lake related problems, and protect the public health, safety, and welfare.

The Blodgett Lake, Lake Management Plan provides management guidelines for:

- o The protection of the residential quality of life at Blodgett Lake; and
- o The continued recreational enjoyment of Blodgett Lake; and
- o The protection of Blodgett Lake's water quality; and
- o The protection and enhancement of fish and wildlife; and
- o The protection of the public health, safety, and welfare.

1.2 Approaches to Lake Management

There are two approaches that residents and property owners of the Matanuska-Susitna Borough may use to address lake related issues. One approach is to initiate a petition as authorized by 17.58 of the Borough Code. This ordinance, which was adopted by voter initiation in 1994, allows members of the public to either prohibit all motorized use on a waterbody or to establish quiet hours (11 p.m. to 8 a.m.), a 100 foot no wake zone from the shoreline, requirement of mufflers on all piston driven engines, and allows special events by permit. Once a petition is filed, a report is drafted by the Planning Department regarding the suitability of the ordinance for the lake in question and public hearings are then held on the matter by the Planning Commission and Assembly. Since this ordinance was adopted by voter initiative, it may not be amended for a period of two years. As of April, 1995 this ordinance is in effect for Wasilla, Cottonwood, Mud, and Finger lakes while all motorized use is prohibited on Cottonwood Creek.

The other approach that may be utilized for managing a lake is a lake management plan. A lake management plan is developed with the input of local property owners and residents. The Borough Planning Department assists the planning effort by collecting background information, developing maps, etc., but it is the property owners and residents who decide policy issues and develop goals and recommendations. The management planning process also allows a more comprehensive approach to addressing lake related concerns. The lake management planning process allows property owners and residents to tailor management guidelines to their particular needs and desires.

1.3 Process

Lake management plans are typically initiated by individuals having concerns about a particular lake or who have experienced conflicts between user groups. These individuals request that the Planning Department of the Matanuska-Susitna Borough complete a lake management plan. With the concurrence of the Planning Commission which is vested with planning authority in the Borough, the Department collects background information on the lake and contacts adjacent property owners and users to participate in the planning process.

Meetings are held with adjacent property owners and users to: 1) identify any problems that may exist, 2) develop recommended alternatives, and 3) consider methods of implementing the recommendations. A draft plan is then developed and a public comment period is held to solicit comments on the draft plan. After the public comment period is closed, comments are reviewed and appropriate modifications made. A meeting may be held with adjacent property owners and users to discuss the comments and proposed modifications. Whether or not this meeting is held depends on the comments received; if the comments call for minor changes or none at all, a meeting is not likely to occur. On the other hand, if the comments seek major changes to the draft plan, a meeting is arranged to discuss the comments and proposed modifications.

After the draft plan has been reviewed by the public, a public hearing on the plan is scheduled with the Borough Planning Commission. At the public hearing anyone may comment on the plan. The Commission considers all oral and written comments received and either recommends to the Assembly adoption of the plan as is or with modifications, or recommends Assembly disapproval of the plan. After Planning Commission action, the plan is scheduled for a public hearing by the Assembly. The Assembly considers all oral and written comments received and either adopts the plan as is or with modifications, or disapproves the plan.

1.4 Ponds, Lakes, and Reservoirs¹

There are no scientific definitions of the terms **lake**, **pond**, and **reservoir**. In general, waterbodies which have a noticeable flow are termed either rivers or streams. "Ponded waters" have little or no current compared with rivers and streams.

A pond is usually described as a small, shallow body of water, with uniform water temperature from top to bottom. There is little wave action and often, an abundance of aquatic plants. Although local definitions may vary, a pond is generally less than ten acres in area and ten feet in maximum depth.

A lake is usually larger than a pond. It may be quite large and deep, with an abundance of cold water at the bottom. It also may exhibit areas of rocky, wave-impacted shoreline as a result of exposure to prevailing winds. The area of land around the lake which contributes water to the lake is the **watershed**. The watershed may be large or small when compared to the area of the lake. The water may enter the lake from the watershed as streams and rivers, or through the ground as groundwater. The term watershed is used interchangeably with **catchment** or **drainage basin**, although the latter term can imply a larger area containing several watersheds or **sub-basins**. The boundaries of a watershed are defined by ridges and hills that divide or separate water movement into one drainage basin or another. The **lake basin** includes the lake bottom as well as the surrounding slopes.

1.5 Lake Lifespan²

Lakes fill in, drain themselves, or just evaporate and disappear. They do not last forever. Although lakes seem permanent in our human time perspective, they are sediment traps, and it is natural for them to fill in gradually with sand, silt, and organic matter. Natural lake aging or **eutrophication** moves from a nutrient-poor (**oligotrophic**) condition to an intermediate (**mesotrophic**) stage of nutrient availability and biological productivity, and finally to a nutrient-rich or highly productive (**eutrophic**) state. Eutrophication - the process of nutrient enrichment and basin filling - may take thousands of years, but it can be accelerated greatly by disruptions to the watershed. Human activities that increase nutrient and sediment loadings to a lake are termed **cultural eutrophication** and include forest clearing, road building, construction, and wastewater discharges.

Trophic conditions in lakes are relative, not absolute - that is, there is no definitive line

¹ This section is taken from Diet For A Small Lake, Prepared by the New York State Department of Environmental Conservation and the Federation of Lake Associations, Inc., 1990.

² This section is taken from Diet For A Small Lake, Prepared by the New York State Department of Environmental Conservation and the Federation of Lake Associations, Inc., 1990.

between oligotrophic and mesotrophic, or between mesotrophic and eutrophic. However, each trophic state has characteristic conditions. Oligotrophic lakes have a low level of organic productivity, clear water, and low nutrient levels. These lakes often are characterized by deep water and steep basin walls. Water in mesotrophic lakes contains a moderate supply of nutrients and organic production. Eutrophic lakes are characterized by a very high level of nutrients which causes a significant increase in the rate of plant growth. As a result, water clarity is greatly reduced, and oxygen depletion is common during the summer months. Eutrophic lakes tend to be shallow and typically, have elevated water temperatures.

Identification of a lake's trophic status is a useful way to determine its general "health", or biological status, from one year to the next and in comparison with other lakes. If a potential problem is identified in a lake, the trophic status can also be used to evaluate management alternatives.

A few lakes are naturally eutrophic. Many lakes and reservoirs are located in naturally fertile watersheds where the soil is highly erodible. Unless the soil remains undisturbed, these lakes have little chance of being anything but eutrophic. Users of these lakes need to recognize and accept the fact that manmade Areas (such as laws, property, or zoning) may not "correct" the conditions. Residents and visitors should adjust their expectations for the appearance and use of such eutrophic lakes.

1.6 General Lake Issues and Concerns

This section describes some of the most common concerns and issues that have been raised by residents and property owners of the Borough. There are three main categories of lake related concerns and issues. One category is water quality related. Activities within the shoreland area can have a direct impact on lake water quality. The shoreland is the land within 500 to 1,000 feet of the normal mean water mark of a lake or pond. The placement of septic Areas in unsuitable soils or too close to the lake or the lack of sanitary facilities at public access points can introduce nutrients and pathogens into the lake. Inadequate soil erosion control during upland construction can increase the loading sediment to the lake. Removal of vegetation along the shoreline or at unsupervised public access points may increase erosion of the bank and loss of its ability to filter runoff.

Another category of concerns and issues is related to the surface use of the lake. Some uses may conflict with one another such as fishing and water-skiing because it is difficult for both activities to occur at the same time and in the same location. Other uses cause conflicts by the nature of how the use occurs such as becoming a nuisance by creating noise during sleeping hours. Some uses of the surface water may create shoreline erosion and hence, sediment loading at the lake and loss of private property.

The last category of lake issues regards the impact of recreational use on wildlife and wildlife habitat. Unsuccessful nesting or above average mortality may occur during the nesting season if nests are harassed, frequented by watercraft, or swamped by wave action.

1.7 Blodgett Lake Issues and Concerns

The Blodgett Lake, Lake Management Plan was initiated by a request from property owners of Blodgett Lake. A meeting was held with residents and property owners. At this meeting, concerns and issues were discussed.

The issues identified included:

- 1) Maintaining the general peacefulness (lack of noise), of the lake especially in the evening and early morning hours; and
- 2) Protection of the wildlife and wildlife habitat, especially loons; and
- 3) Provide a safe place for swimmers and water skiers; and
- 4) Erosion caused by wakes; and
- 5) Protection of the quiet, residential character of the lake; and
- 6) Surface uses that create noise, disturb wildlife, or create wakes are the primary concerns of property owners and residents.

It is the desire of the majority of property owners and residents of Blodgett Lake that the quiet, residential use and character of the lake be protected. The present state of the lake may be characterized as quiet, with active loon nests. Property owners are concerned that the lake will be increasingly used by personal watercraft (a.k.a. jet skis or wave runners) which they believe create several negative impacts. The negative impacts include: wildlife harassment, creation of turbid water conditions, shoreline erosion, noise, and a lower quality of life and experience at the lake.

2 **Inventory of Existing Conditions**

2.1 Location

Blodgett Lake is located just north of George Parks Highway at approximately milepost 50.5 (see Figure 1) and is accessed by Randall Road (see Figure 2). Blodgett Lake is part of the Meadow Lakes Community Council (see Figure 3).

2.2 Land Ownership

There are 70 lots with shoreline on Blodgett Lake. The lots range in size from 0.17 acres to 15.37 acres. The average lot size is 1.82 acres. No publicly owned land is located at Blodgett Lake.

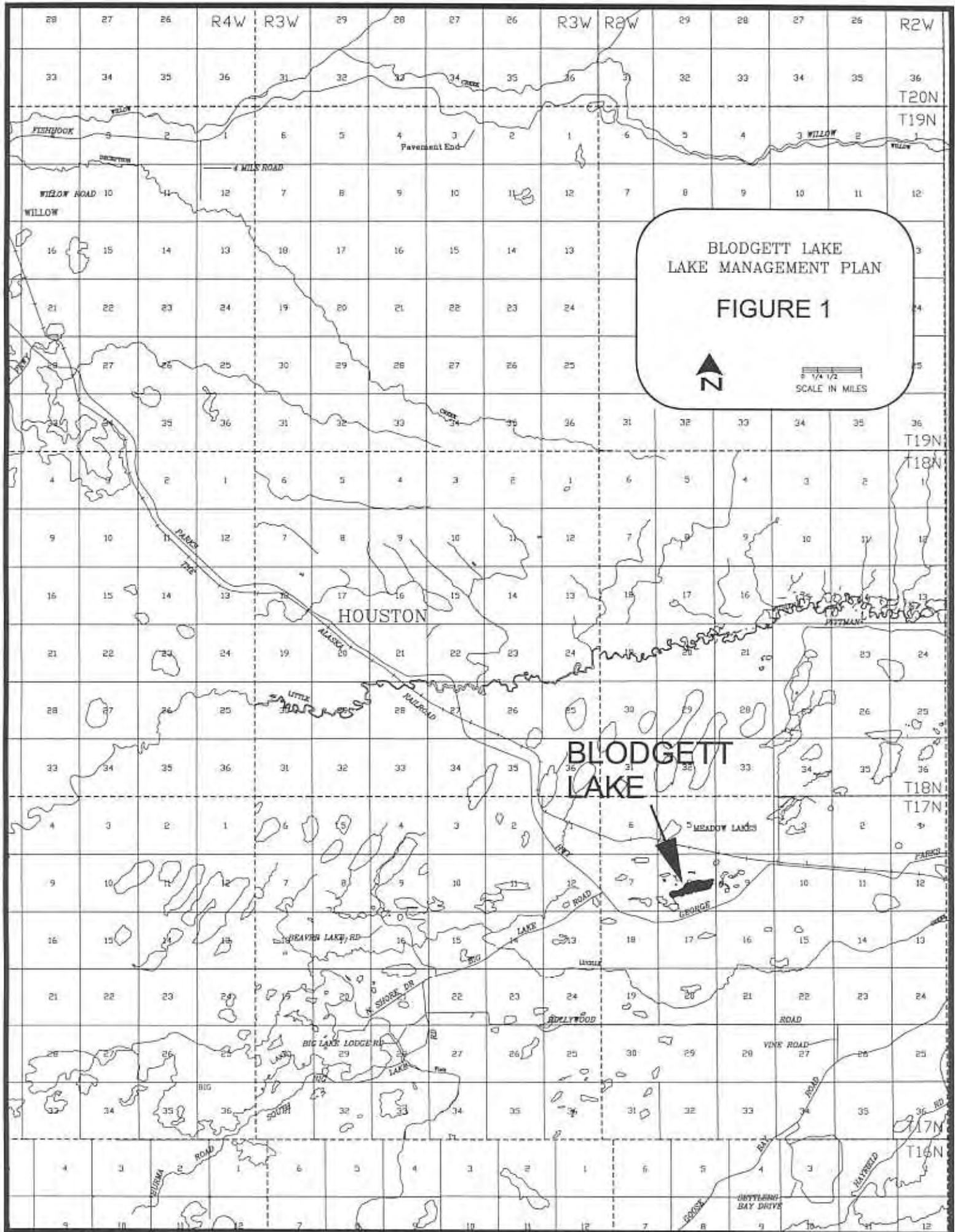

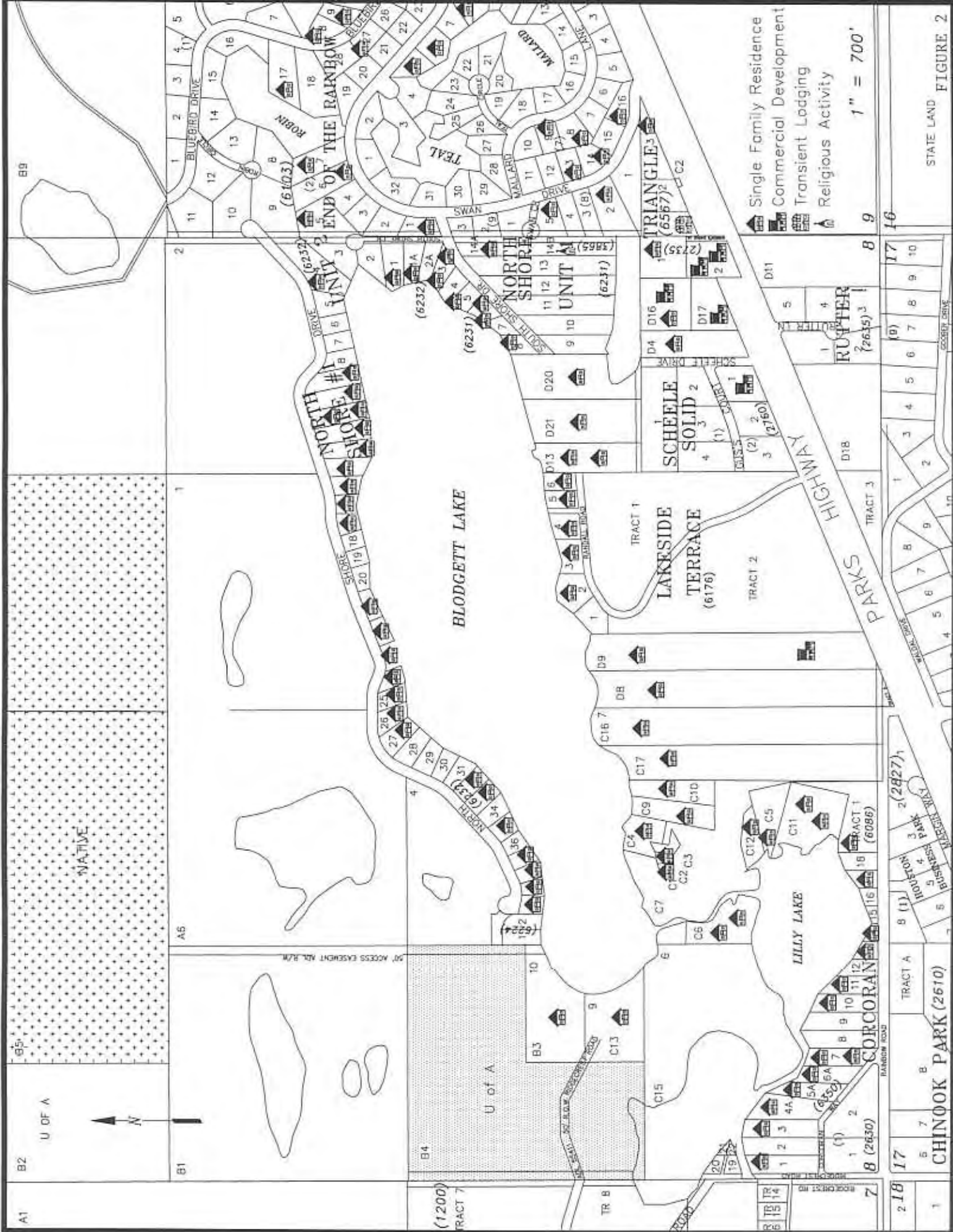

Single Family Residence
 Commercial Development
 Transient Lodging
 Religious Activity

1" = 700'

STATE LAND FIGURE 2

CHINOOK PARK (2610)
 TRACT A
 9 (11)
 5
 BUSINESS PARK
 3
 4
 2 (2827)
 VACANT LOTS
 1
 2
 3
 4
 5
 6
 7
 8
 9
 10
 11
 12
 13
 14
 15
 16
 17
 18

U OF A

N

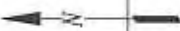

NATIVE

BLODGETT LAKE

LILLY LAKE

LAKESIDE
 TERRACE
 (6176)
 TRACT 1
 TRACT 2

SCHEELE
 SOLID
 (6231)
 TRACT 1
 TRACT 2
 TRACT 3

PARKS
 HIGHWAY
 TRACT 3

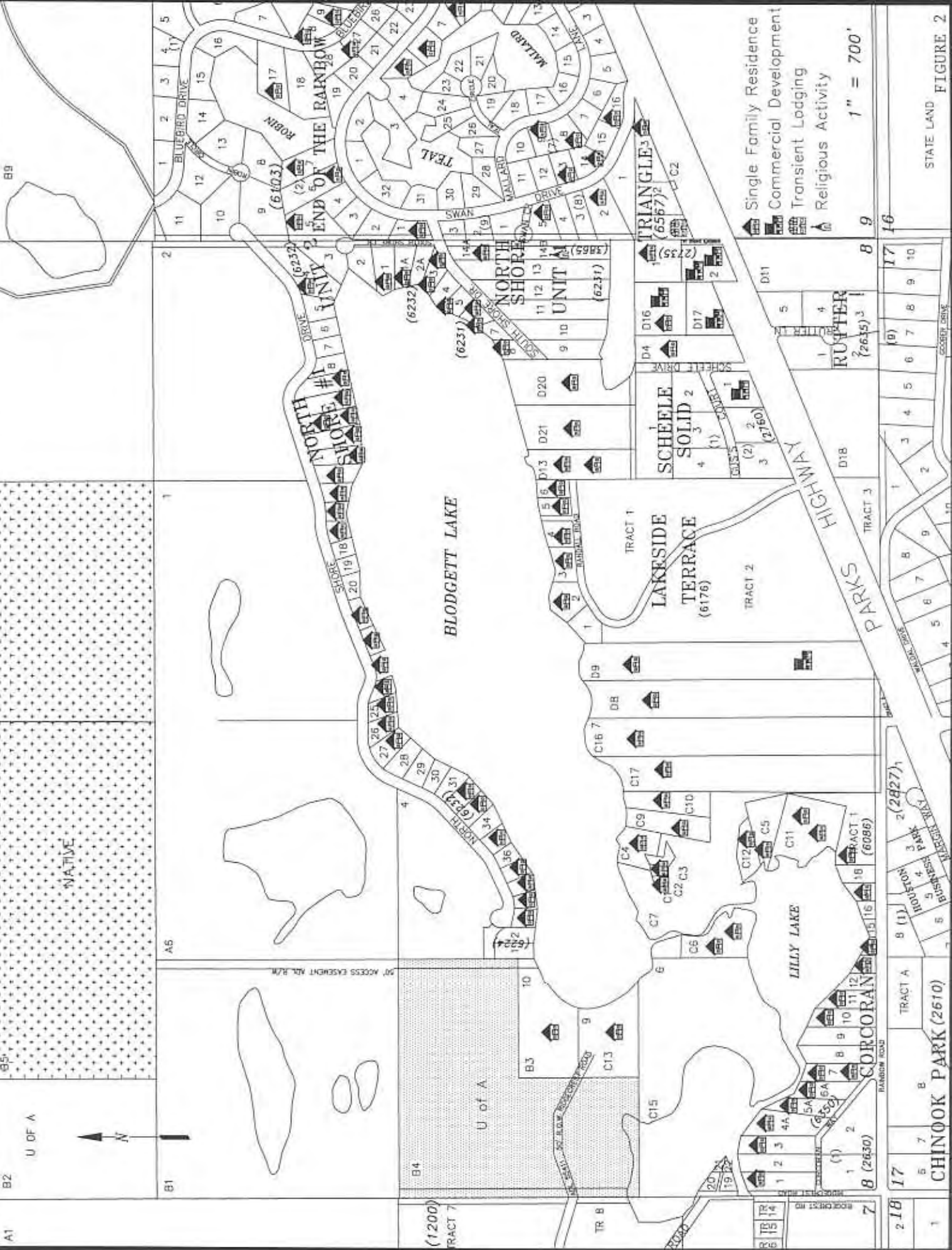

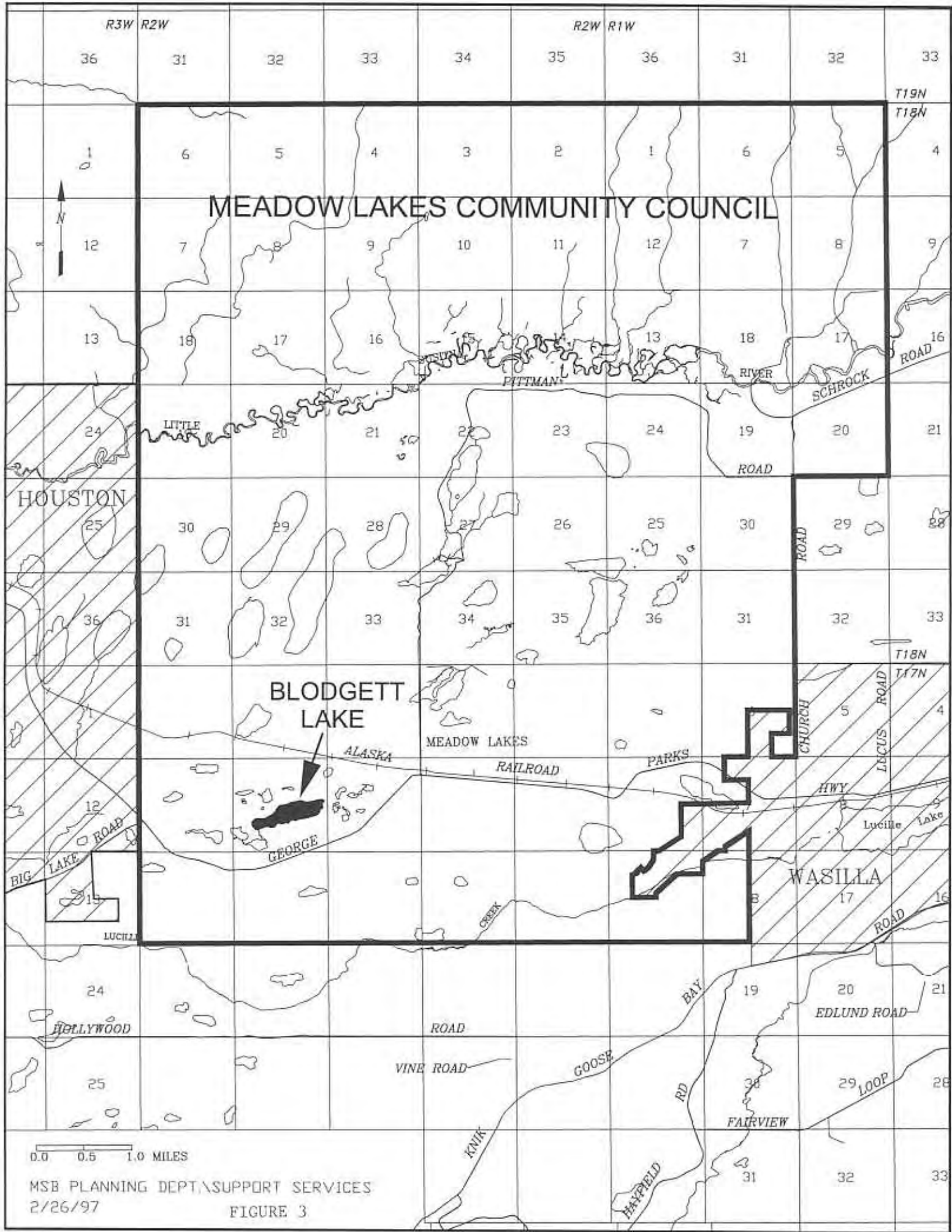

2.3 Existing Plans

State

The State plan affecting the Blodgett Lake is the Willow Sub-Basin Area Plan. The Willow Sub-Basin Area plan, adopted in February, 1982 contains management intent for State and Borough lands for an area of encompassing approximately one million acres. Blodgett Lake is located within the Wasilla management unit. Generally speaking, the plan's overall intent for public lands within the management unit is to provide a mixture of land for settlement, public recreation and habitat protection. The plan recommends that the parcel of land owned by the state of Alaska, on the eastern shore of Blodgett Lake be managed for recreational purposes.

Borough

Borough plans that address Blodgett Lake in some manner include the Borough-wide Comprehensive Plan, adopted in 1971; the Core Area Comprehensive Plan, adopted 1993 as amended, in 1994; Matanuska-Susitna Borough Coastal Zone Management Plan, as amended; and the Borough-wide Long Range Transportation and Public Facilities Plans.

The Borough-wide Comprehensive Plan does not make specific recommendations for the Blodgett Lake area.

Blodgett Lake lies within the Matanuska-Susitna Borough Coastal District (District), as defined within the Matanuska-Susitna Borough Coastal Management Plan, as amended. The Coastal Management Plan seeks to direct the course of local, state, or federal development within the District in a manner that protects the important land and water resources of the District. The adopted policies of the Coastal Management Plan are used to evaluate development proposals vis-a-vis resource values in an effort to ensure that the proposals are consistent with the plan's goals and objectives. Local development includes actions that trigger a Borough subdivision, planning or zoning action. For example, a variance application to build a habitable structure or garage closer than 75 feet from the ordinary high water mark of Blodgett Lake would be reviewed to determine whether or not it is consistent with the Coastal Zone Management Plan. Construction within waterbodies are also reviewed for consistency with the plan. Uncovered floating or pile supported docks which do not extend more than 40 feet beyond the ordinary high water line and do not exceed 400 square feet in size may obtain a general concurrence. Metal drums, however, may not be used as floatation devices.

The Borough Long Range Transportation Plan was adopted in 1987 and is presently being updated via the 2015 Transportation Plan. The plan does not identify any new road corridors in the vicinity of Blodgett Lake.

The Borough Public Facilities Plan makes recommendations on a regional basis for the provisions of public services including the development of public facilities necessary to the provision of those services. Services included in the plan include: public safety (fire protection, emergency medical services, and emergency preparedness); library; historical preservation; governmental administration; education; parks, recreation and open space; trails; and utilities. All of these elements affect the Blodgett Lake Area in some way, but the Parks, Recreation, and Open Space; and Trails elements would have the most impacts relative to the concerns of this management plan.

2.4 Existing Regulations - Public

This section describes the principle regulations affecting use and development in the Blodgett Lake area. This section is **NOT** meant to provide an all encompassing description of all activities and uses that require permits or approvals from local, state, or federal agencies. Prior to undertaking any development activity, individuals should contact the appropriate local, state, and federal agencies and obtain the required permits and approvals.

Federal

Any work which results in the dredging or placing of structures or fills in tidal (ocean) waters, streams, lakes, or wetlands requires a 404 permit from the U.S. Army Corps of Engineers.

Migratory birds, which include loons and grebes, are protected by the Migratory Bird Treaty Act. The Act, among other things, prohibits the "take" of migratory birds where "take" is defined to mean pursuing, killing, etc., migratory birds. Destruction of nest sites, eggs, or the birds themselves is a violation of the Act.

State

The Alaska Department of Environmental Conservation (DEC) provides regulations for wastewater disposal. DEC wastewater/septage regulations [18 AAC 72,015(f)] state that no holding tank, septic tank, soil absorption Area, seepage pit, privy, or other waste water collection, treatment, or disposal Area may be within 100 feet, measured horizontally, of the mean annual high water level of a lake, river, stream, spring, slough, or the mean higher high water level of coastal waters.

In addition to the U.S. Army Corps of Engineers 404 permit requirements, any activity within streams and certain work within lakes requires a Title 16 permit from the Department of Fish and Game. Activities which result in the construction of a dam which impounds water or places a weir, culvert, or temporarily blocks a stream

requires a Title 16 permit. In February, 1994 the Habitat and Restoration Division of Fish and Game issued a one year, general permit allowing the vehicle movement on frozen water surfaces in southcentral Alaska. The permit allows certain motorized vehicles less than 2,000 pounds gross vehicle weight and wheeled vehicles less than 10,000 pounds gross vehicle weight to travel upon frozen water surfaces in southcentral Alaska without a special permit. Finally, the general Alaska Department of Fish and Game fishing regulations apply to Blodgett Lake.

Borough

Several Borough-wide ordinances address the development and use of land adjacent to Blodgett Lake. The regulations are contained within the Borough's planning (Title 15), subdivision (Title 16), zoning (Title 17), and real property management (Title 23) ordinances. The adopted Coastal Management Plan described earlier, because of its enforceable criteria, also regulates development activities within and near Blodgett Lake.

Title 15 establishes and describes the general functions of the Planning Commission (both planning and zoning functions) and the Board of Adjustment and Appeals. Title 15 also describes the comprehensive plan and purposes. Once adopted, the Blodgett Lake, Lake Management Plan will become an instrument of Borough policy similar to the other plans adopted by the Borough Assembly.

Title 16 provides the subdivision development standards within the Borough and establishes the Platting Board. Two of Title 16's requirements that are of special note to development at Blodgett Lake include a minimum lot size of 40,000 square feet, and a minimum lot width when measured at the lake's water line of one hundred twenty-five feet unless community septage is provided, then the minimum width may be eighty-five feet (see Figure 4).

The Borough has a Borough-wide comprehensive plan which is implemented, in part, through the Borough-wide zoning ordinance. Presently, the Borough undertakes its comprehensive planning on a community by community basis. As most comprehensive plans are implemented through a zoning ordinance, a number of different zoning ordinances exist within the Borough and are identified as Special Use Districts. For example, the cities of Houston, Palmer, and Wasilla all have their own comprehensive plans and all have zoning ordinances unique to their cities. Title 17 contains these various zoning ordinances of the Borough. A list of Title 17's chapters follows.

- 17.01 Acknowledgment of Existing Land Use Regulations.
- 17.03 Public Notification.
- 17.04 Nancy Lake State Recreation Area Special Land Use District.
- 17.08 Hay Flats Recreation Area Special Land Use District.

Figure 4

General Setback Requirements and Lot Size* Requirements

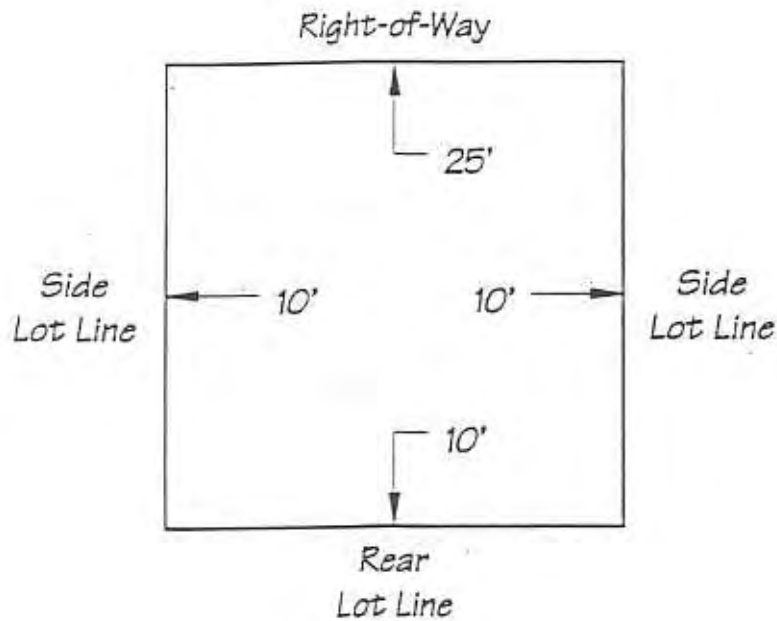

Ordinary High Water Line
of Lake (no community septage)

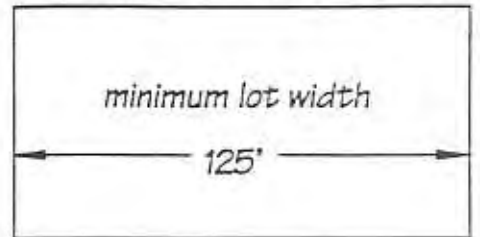

Ordinary High Water Line
of Water Body or Watercourse

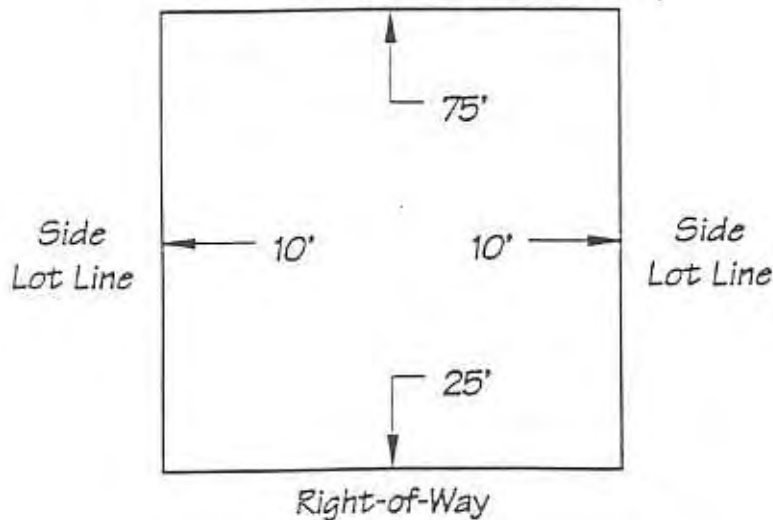

Ordinary High Water Line of
Lake (community septage available)

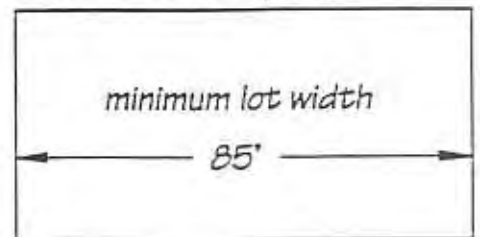

*All lots must be a minimum of 40,000 sq. ft.

- 17.15 Palmer Special Land Use District.
- 17.17 Denali State Park Special Land Use District.
- 17.18 Chickaloon Special Land Use District.
- 17.19 Glacier View Special Land Use District.
- 17.29 Flood Damage Prevention.
- 17.36 Residential Planned Unit Development.
- 17.40 Houston Land Use Ordinance.
- 17.45 Wasilla Special Use District.
- 17.48 Mobile Home Park Ordinance.
- 17.52 Residential Land Use District.
- 17.55 Setbacks and Screening Easements.
- 17.56 Violations and Enforcement.
- 17.58 Regulation of Motorized Use of Certain Lakes and Waterways.
- 17.60 Conditional Uses.
- 17.65 Variances.
- 17.70 Regulation of Alcoholic Beverage Uses.
- 17.75 Single Family Residential Land Use District.
- 17.80 Non-conforming Structures.
- 17.90 Regulation of Adult Businesses.
- 17.99 Fees.

Zoning regulations that are of special note to development activities at Blodgett Lake include conditional use permit requirements for commercial junkyards, salvage and automobile wreckage yards, sanitary landfills, community correctional rehabilitation centers, mobile home parks and establishments selling liquor. Other land use regulations include: setback requirements and a petition process to limit or eliminate motorized use of lakes and conditional use permits.

Presently, all structures must be a minimum of twenty-five feet from a right-of-way and ten feet from all lot lines. In addition, the voters of the Borough approved by initiative, a requirement that all habitable structures and garages must be located at least seventy-five feet from the ordinary high water mark of any waterbody or watercourse (see Figure 3). In 1994, the voters of the Borough also adopted by initiative, an ordinance that allows by petition and subsequent adoption by the Assembly the following restrictions to be placed on lakes and waterbodies: 1) limiting or elimination of motorized use of lakes, 2) establishment of quiet hours, and 3) establishment of a one hundred foot no wake zone from the ordinary high water mark. The Borough also requires that any development which seeks to establish or operate a mobile home park, junkyard, refuse area or landfill, or dispense alcohol must first obtain a conditional use permit.

The Borough received approximately 350,000 acres of land through the Municipal Entitlement Program. The Planning Department of the Borough manages and disposes of these lands through the policies and procedures described within Title 23. As of November, 1996, the Borough did not own any land within Blodgett Lake area.

2.5 Present Lake Usage

The present use of Blodgett Lake may be characterized as being quiet and residential in character. The property immediately adjacent to Blodgett Lake is primarily residential, held in private ownership. Residents live at Blodgett Lake throughout the entire year. Lake front property owners and part-time or “weekend” visitors are the primary users of Blodgett Lake. They boat, swim, water ski, and fish at the lake. The use of personal watercraft (i.e., jet skis and wave runners) is just becoming a regular occurrence at Blodgett Lake. The lake is shallow and property owners are concerned that the future use of personal watercraft will create erosion of the shoreline, turbidity, loss of wildlife, and noise.

2.6 Lake Characteristics

Blodgett Lake is a small and narrow lake (see Table 1). The lake’s average depth of about 10 feet and its narrowness make it susceptible to noise and the creation of turbid conditions. More specifically, the lake is used by watercraft that move quickly, have sharp and fast turning movements and operate repetitively in specific areas creating turbid conditions due to the lake’s shallow depth. In addition, since the lake is relatively narrow and small, repetitive uses such as water skiing and the use of personal watercraft, i.e., jet skis and wave runners create noise and shoreline erosion problems.

Table 1
Characteristics of Blodgett Lake

Surface Acres	57.6 acres
Volume	614.4 acre feet
Maximum Depth	29 feet
Mean Depth	10.7 feet
Shoreline Length	1.63 miles

3 **Goals**

Goals describe the future expectations of residents, property owners, and users for a lake. The following goals reflect the aspirations of Blodgett Lake residents and property owners. Their principal concerns are: water quality, access, wildlife, quality of life, and the residential character of the area. The goals are not shown in priority order as they are interdependent.

3.1 Water Quality

Blodgett Lake is a significant natural resource and it is the desire of property owners, residents, and users of Blodgett Lake to maintain or improve the lake's water quality.

3.2 Recreation and Residential Character

The recreational opportunities offered at Blodgett Lake should be maintained and enhanced but suited to the lake's particular characteristics and should not detract from the quality of experience at the lake.

Blodgett Lake offers a unique setting for residential use and this quality should be protected and preserved.

Upland development should occur in an appropriate manner to ensure that pollution, noise, or other environmental degradation of the lake and uplands does not take place.

Uses of the lake should be compatible or enhance the present character of the lakes which is of a low-impact, quiet, residential character.

3.3 Wildlife

The ability of Blodgett Lake to remain a migratory bird (loons) nesting site should be preserved. Recreational use of the lake should be compatible with wildlife nesting.

4 **Management Issues, Alternatives, and Recommendations**

The management issues at Blodgett Lake were identified by the lake's property owners and residents. This section describes several methods for alleviating problems and provides preferred recommendations. The alternatives were developed through discussions with property owners and residents, and a review of how other lakes in the Borough are managed and how lakes in other states have been managed.

4.1 Wildlife

Management Issue The principle wildlife of concern to the Blodgett Lake Area residents and property owners is the retention and protection of loon and other waterfowl nesting sites. Presently, the lake has active nests and there is a concern that increased motorized activity on the lake will harm the existing nesting sites. The remainder of this section will discuss alternatives for preserving and protecting the loon, grebe and mallard nests.

Loon nesting sites and successful breeding may occur on lakes having development and recreational use if sufficient habitat is available and the nesting sites are not repeatedly disturbed. Loons will nest on shore although islands offer the optimal nest sites. Nesting periods generally begin in late May through late June, however, if a nest is abandoned a loon pair may attempt a new nesting and this second nesting period runs through late July. In order to retain and protect the existing nest site, lake users need to become informed of how recreation and development affects loons, as well as avoid the nest site during the critical nesting/mating/rearing periods. While grebes commonly have the same breeding period as loons, grebe nest sites are much different. Grebes prefer to nest on floating objects, typically vegetation.

Nest sites and breeding may be disturbed in a number of ways. Steady activity that comes near a nest site, whether motorized or non-motorized, may cause the nest to be abandoned. High motorized activity near a nest site may cause chick mortality due to separation from the adult or wakes caused by motorized craft may destroy the nest or wash away the eggs. In addition to damaging a nest, activities occurring too close to a nest will cause loons to leave an active nest thereby allowing predators such as gulls and ravens to eat the unprotected eggs or chicks. Discarded mono-filament line presents another threat to loons and other birds as it may entangle birds and chicks and ultimately kill them through starvation, predation, or by drowning.

Alternatives If nothing is done to inform lake users of the sensitivity of loons and grebes to water borne activities and development, active nests will not be found on Blodgett Lake in the future. In order to maintain the presence of loons and grebes, it is necessary that some proactive steps be implemented.

Recommendations Most individuals will not disturb a nest site if they are informed of its location and the proper behavior when near it. It is recommended that a number of techniques be employed to provide the public with information about loons and grebes. First, existing nest sites where regular loon or grebe nests have occurred should be encircled by a number of buoys marked with "Loon (or Grebe) Nesting Site - Do Not Approach" placed at least 150 feet (200 feet preferred) from the nest's boundary. Appendix #1 provides an illustration of a low cost, effective buoy. Loon and grebe alert notices and general information about loons should be posted at where best able to inform the public about proper "loon or grebe etiquette" (see Appendix #1). To further protect the nesting sites, it is recommended that an annual letter be mailed to property owners in the area to remind them of the sensitive nesting period. Other recommendations to protect birdlife include reducing the size of watercraft motors in order to reduce wakes, erosion and noise and to prohibit those watercraft and surface water activities that create repetitive noise and large wave actions; examples being jet skis and waterskiing, respectively.

4.2 Noise

Management Issue Blodgett Lake has a history of low-impact, quiet, recreational use of the lake. Residents and property owners of the area wish to maintain this characteristic of the lake. Additionally, Blodgett Lake is relatively small and shallow and therefore not of sufficient size to adequately support recreational use that generates a large number of wakes.

Alternatives Five alternatives may be considered for this management issue; namely: 1) do nothing, 2) prohibit all motorized use, and 3) limit the size/power of motors that may be used on the lakes, 4) prohibit jet skis, wave runners and other similar personal watercraft, and 5) establish quiet hours.

The first alternative, "Do Nothing", ignores problems that may be associated with noise. The "Do Nothing" alternative also ignores one of the primary reasons residents and property owners requested that a lake management plan be developed. This alternative is therefore rejected.

The second alternative would prohibit all motorized use of the lake. While this alternative would eliminate noise associated with motors, it would also restrict craft that do not generate noise such as boats with electric motors. A complete ban on motorized use would also eliminate uses that are not associated with the noise problem. This alternative is therefore also rejected.

The third alternative is a slight modification of the second alternative where a horsepower limit is placed on watercraft using the lake. Low horsepower engines allow for motorized use of the lake but do not create the unintended negative effects of erosion, noise and conflicts with other non-motorized activities such as canoeing or sailing. It is the recommendation of some property owners and residents that Blodgett Lake, due to its small size and shallowness have a boat horsepower limit of ten horsepower.

Another alternative is to combine the use of quiet hours with limits on the type of motors allowed to use the lake. The use of quiet hours creates a period of time when motorized use that creates wakes or is repetitive in nature is prohibited. Quiet hours also allow use of the lake during the quiet hour period for quiet, unobtrusive transit of the lake for trolling/fishing.

Recommendation Residents and property owners of the area initiated the lake management planning process, for among other concerns, to protect the existing quiet, low-impact, recreational use of Blodgett Lake. It is therefore recommended that quiet hours be established for Blodgett Lake that consist of 10 p.m. to 8 a.m. Sunday through Thursday and 11 p.m. to 8 a.m. Friday and Saturday. For similar reasons the use of jet skis or wave runners or other similar personal watercraft should be prohibited and a watercraft motor limit of ten horsepower should be established.

5.0 Implementation

Plans may be implemented in a number of ways but are typically implemented through capital improvement programs and subdivision and zoning ordinances. Within the Borough, residents may also petition for motorized use restrictions on lakes and this ordinance may be used to implement a lake management plan. This ordinance was discussed by Blodgett Lake property owners and found not to be needed at this time. Plans may also provide for private implementation through public information campaigns and a list of best management practices that may be used by the public. The problems facing Blodgett Lake at this time do not warrant a special zoning or subdivision ordinance nor do they warrant implementation of the Borough's motorized use of lakes ordinance. Therefore, this plan will utilize a combination of public information and best management practices to implement the plan. The Borough should utilize its citation authority for infractions of the recommended management guidelines of this plan. In addition, a lake management ordinance³ may be adopted containing a general provisions section that provides limited guidelines, e.g. wildlife protection, quiet hours, no-wake zones, and bans on overnight camping. Blodgett Lake residents and property owners should be contacted to determine whether or not Blodgett Lake should be included in such an ordinance. A description of the plan's implementation guidelines follow.

Watercraft Limits As stated above, Blodgett Lake is relatively small and shallow and not suitable for large watercraft, watercraft with large motors, or those creating repetitive wave actions. Residents living adjacent to the lake seek to have their shorelines protected from erosion caused by large wakes. Loons and other bird life nesting on a small lake are placed at an increased risk of disturbance from wakes caused by watercraft with large horsepower engines or by use creating repetitive wake action. The historical use of Blodgett Lake has been low impact recreational; residents and property owners wish to continue this character. After consideration of the requests and desires of property owners and residents of the lake and after considering public testimony the Borough Assembly determined that the establishment of a ten horsepower motor size limit on watercraft and a prohibition on the use of jet skis or wave runners or other similar watercraft are the most appropriate guidelines for the continual enjoyment and protection of Blodgett Lake.

Loons and Grebes To protect loons and grebes it is recommended that a sign (see Appendix #1) be posted where best able to inform the public about loon and grebe critical nesting periods, e.g. "Loon (or Grebe) Alert!" Further, buoys should be

³ Note: Due to the diversity of lakes in the Borough and the many requests for lake management plans and guidelines that have been received, a Borough-wide ordinance consisting of a general provisions section containing rules for all lakes, e.g., don't litter and a more specific provisions section containing several lake categories with different guidelines ranging from none to several is being considered.

placed a minimum of 150 feet (200 feet preferred) from active nest sites. Appendix #1 provides information on buoy construction and placement. Blodgett Lake area residents and property owners and the Borough should cooperate in implementing the loon and grebe protection program. Additionally, the harassment of loons and other lake related wildlife such as grebes may become subject to fines under the proposed lake management ordinance described above.

Quiet Hours Blodgett Lake is a small residential lake and not suitable for large watercraft or the frequent use of jet skis or wave runners. Further, the upland development is predominately low-impact, quiet recreational in character. To protect the shoreline and existing quiet, low-impact recreational character of the area and unobtrusive recreational use, quiet hours should be imposed on the lake during which no motorized watercraft that results in loud sounds or noises, or is of a repetitive nature such as water skiing (electric motors are allowed). Quiet hours of 10 p.m. through 8 a.m. Sunday through Thursday and 11 p.m. to 8 a.m. Friday and Saturday are established for the lake.

Public Information Information should be posted using a signboard at public access areas to inform users to pack out what they pack in and of the adopted management guidelines for the lake. Individual mailings should be sent to all property owners advising them of this plan's guidelines.

Trash and Fireworks Firework displays are illegal without a special permit issued by the Borough Planning Department; never-the-less, individuals generally display fireworks throughout the Borough. Firework displays create two problems, noise from explosions and trash from the fireworks. Firework displays may also start forest fires. The Borough does not have the resources to actively police the illegal use of fireworks and such use is a low priority for the Alaska State Troopers. However, the Borough should advise property owners of the law and inform them to be considerate of their neighbors, avoid polluting the lake with debris, and avoid forest fires and disturbance of waterfowl.

APPENDIX #1

SIGN FLOAT FOR LOON NESTS

(NOT LIKELY TO TURN OVER
IN THE STRONGEST WIND)

AERIAL VIEW

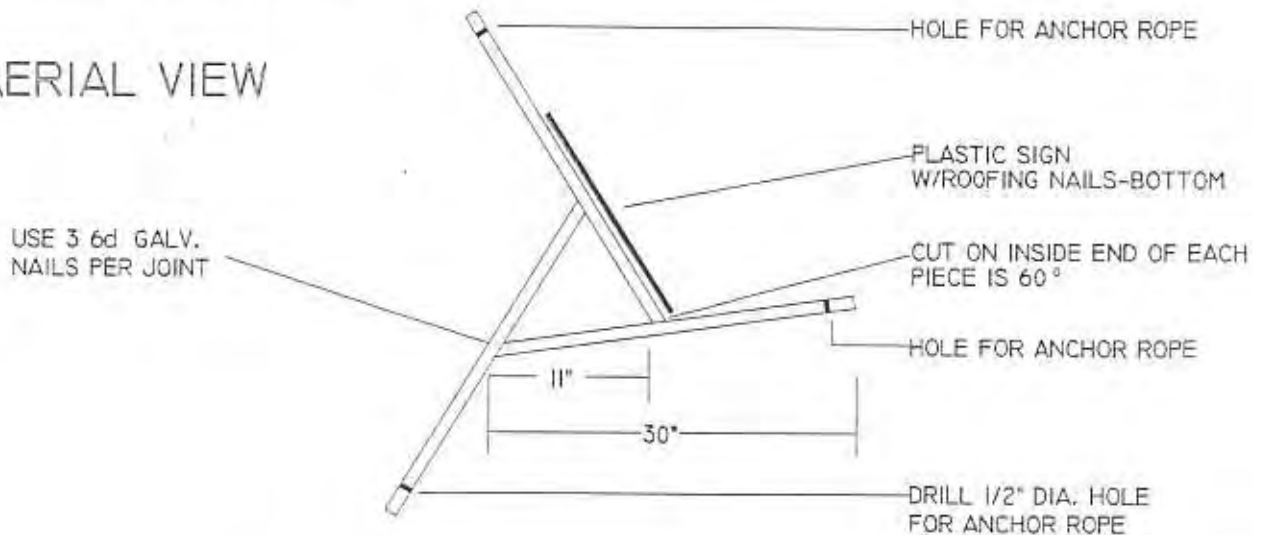

VIEW FROM WATER

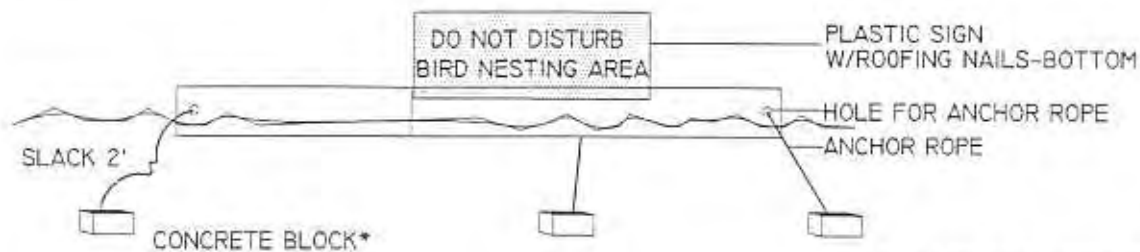

*GALLON MILK JUGS FILLED WITH SAND
COULD REPLACE CONCRETE BLOCKS

NEST

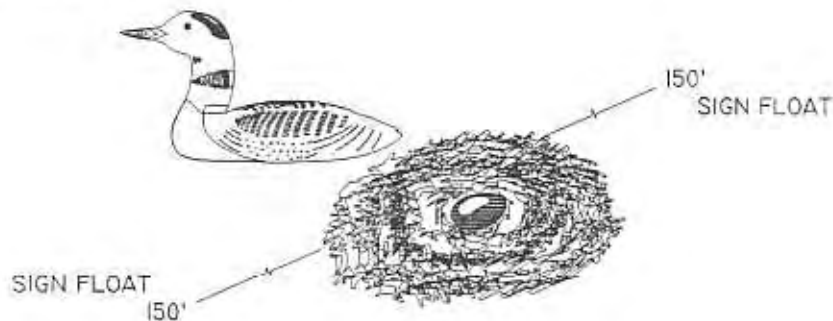

MATERIALS LIST

- 3 - 1"x 4"x 30"
WHITE PINE OR
NO. WHITE CEDAR
- 9 - 6d .GALV BOX NAILS
- 5 - 1" ROOFING GALV. NAILS
- 1 - LOON SIGN
- 2 - 3 CONCRETE BLOCK *
FOR ANCHORS
- ENOUGH 1/4" NYLON ROPE
TO REACH BOTTOM OF LAKE
FOR ANCHOR

The platforms should be attached with two anchors a minimum of 150 feet from the nest (more, if needed to avoid disturbing the loons) and be clearly visible, yet not be a boating hazard. Signs should be removed after nesting is completed (usually by mid-July) each year to preserve their use. Signs should be stored over the winter in a dry area.

LOON ALERT



**Help keep this lake safe
for loons and other wildlife:**

1. Watch loons from a distance.
2. Pick up fishing line and other litter that may entangle loons.
3. Keep your dog on a leash.

Breeding loons have declined or disappeared from other U.S. states due to human disturbance and habitat loss. Wildlife harassment is illegal. Please report violations to Fish and Wildlife Protection (State Troopers) or call (800) 478-3377. For loon information write: Alaska Department of Fish and Game, Division of Wildlife Conservation, 333 Raspberry Road, Anchorage, AK 99518.



STEER CLEAR!



**BOATERS – Stay at least 100 feet away
from nesting Red-necked Grebes.**

Grebes are duck-sized birds that nest on floating vegetation and debris in shallow water.

Wakes from watercraft will destroy their nests and kill their eggs and chicks.

Go slowly along shorelines and avoid nesting areas.

– HELP PROTECT ALASKA'S WILDLIFE –

Wildlife harassment is illegal. Report violations to Fish and Wildlife Protection (State Troopers) or call (800) 478-3377.

This sign was produced by a grant to the Alaska Watchable Wildlife Trust Fund, c/o Alaska Conservation Foundation, 430 W. 7th Avenue #215, Anchorage AK 99501 (907) 276-1917.

POSTED BY ALASKA DEPT. FISH AND GAME

