

RAINBOW LAKE LAKE MANAGEMENT PLAN

MATANUSKA-SUSITNA BOROUGH
PLANNING DEPARTMENT

Adopted
November 7, 1995

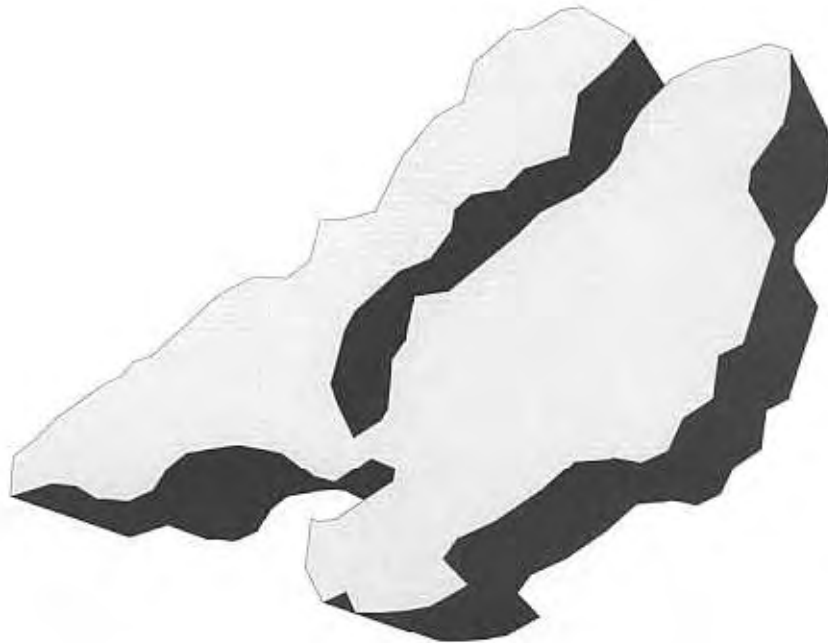

RAINBOW LAKE MANAGEMENT PLAN

November, 1995

by: John Duffy, Director of Planning

Table of Contents

	Page
1. Introduction	1
1.1 Purpose	1
1.2 Approaches to Lake Management	1
1.3 Process	2
1.4 Ponds, Lakes and Reservoirs	3
1.5 Lake Lifespan	3
1.6 General Lake Issues and Concerns	4
1.7 Rainbow Lake Issues and Concerns	5
2. Inventory of Existing Conditions	5
2.1 Location	5
2.2 Land Ownership	5
2.3 Existing Plans	6
State	6
Borough	6
2.4 Existing Regulations	7
Federal	7
State	7
Borough	8
Private	10
2.5 Present Lake Usage	10
3. Goals	10
3.1 Water Quality	11
3.2 Recreation and Residential Character	11
3.3 Wildlife	11
3.4 Access	11
4. Management Issues, Alternatives and Recommendations	11
4.1 Access	12
4.2 Wildlife	12
4.3 Noise	13
5. Implementation	14

List of Figures

Figure 1: Location Map

Figure 2: Meadow Lakes Community Council Boundary and Planning Area

Figure 3: Land Ownership

Figure 4: General Setback Requirements and Lot Size Requirements

Appendix #1: Bird nesting area buoys, Loon Alert! and Steer Clear! posters

1 Introduction

1.1 Purpose

Lake management plans are developed for a variety of purposes. Most often lake front property owners request management plans because increased development or the provision of new public access brings about increased lake usage and a corresponding increase in user conflicts. As more people use a lake conflicts among users may occur, bird nesting sites (especially loons and grebes) may be disturbed, environmental degradation may occur, and the overall quality of the experience may decline. The most often cited complaints are noise generated from watercraft during the evening and night hours and inappropriate use of public access points. A lake management plan seeks to present policies and strategies which attempt to balance the various demands placed upon a lake, solve lake related problems, and protect the public health, safety and welfare.

The Rainbow Lake, Lake Management Plan provides management guidelines for:

- o The protection of the residential quality of life at Rainbow Lake; and
- o The continued recreational enjoyment of Rainbow Lake; and
- o The protection of Rainbow Lake's water quality; and
- o The provision of controlled and maintained access; and
- o The protection and enhancement of fish and wildlife; and
- o The protection of the public health, safety and welfare.

1.2 Approaches to Lake Management

There are two approaches that residents and property owners of the Matanuska-Susitna Borough may use to address lake related issues. One approach is to initiate a petition as authorized by 17.58 of the Borough Code. This ordinance, which was adopted by voter initiation in 1994, allows members of the public to either prohibit all motorized use on a waterbody or to establish quiet hours (11 p.m. to 8 a.m.), a 100 foot no wake zone from the shoreline, requirement of mufflers on all piston driven engines, and allows special events by permit. Once a petition is filed a report is drafted by the Planning Department regarding the suitability of the ordinance for the lake in question and public hearings are then held on the matter by the Planning Commission and Assembly. Since this ordinance was adopted by voter initiative it may not be amended for a period of two years. As of April, 1995 this ordinance is in effect for Wasilla, Cottonwood, Mud and Finger lakes while all motorized use is prohibited on Cottonwood Creek.

The other approach that may be utilized for managing a lake is a lake management plan. A lake management plan is developed with the input of local property owners and residents. The Borough Planning Department assists the planning effort by collecting background information, developing maps, etc., but it is the property owners and residents who decide policy issues and develop goals and recommendations. The management planning process also allows a more comprehensive approach to addressing lake related concerns. The lake management planning process allows property owners and residents to tailor management guidelines to their particular needs and desires.

1.3 Process

Lake management plans are typically initiated by individuals having concerns about a particular lake or who have experienced conflicts between user groups. These individuals request that the Planning Department of the Matanuska-Susitna Borough complete a lake management plan. With the concurrence of the Planning Commission which is vested with planning authority in the Borough, the Department collects background information on the lake and contacts adjacent property owners and users to participate in the planning process.

Meetings are held with adjacent property owners and users to: 1) identify any problems that may exist, 2) develop recommended alternatives, and 3) consider methods of implementing the recommendations. A draft plan is then developed and a public comment period is held to solicit comments on the draft plan. After the public comment period is closed, comments are reviewed and appropriate modifications made. A meeting may be held with adjacent property owners and users to discuss the comments and proposed modifications. Whether or not this meeting is held depends on the comments received; if the comments call for minor changes or none at all, a meeting is not likely to occur. On the other hand, if the comments seek major changes to the draft plan, a meeting is arranged to discuss the comments and proposed modifications.

After the draft plan has been reviewed by the public, a public hearing on the plan is scheduled with the Borough Planning Commission. At the public hearing anyone may comment on the plan. The Commission considers all oral and written comments received and either recommends to the Assembly adoption of the plan as is or with modifications, or recommends Assembly disapproval of the plan. After Planning Commission action, the plan is scheduled for a public hearing by the Assembly. The Assembly considers all oral and written comments received and either adopts the plan as is or with modifications, or disapproves the plan.

1.4 Ponds, Lakes, and Reservoirs¹

There are no scientific definitions of the terms **lake**, **pond**, and **reservoir**. In general, water bodies which have a noticeable flow are termed either rivers or streams. "Ponded waters" have little or no current compared with rivers and streams.

A pond is usually described as a small, shallow body of water, with uniform water temperature from top to bottom. There is little wave action and, often, an abundance of aquatic plants. Although local definitions may vary, a pond is generally less than ten acres in area and ten feet in maximum depth.

A lake is usually larger than a pond. It may be quite large and deep, with an abundance of cold water at the bottom. It also may exhibit areas of rocky, wave-impacted shoreline as a result of exposure to prevailing winds. The area of land around the lake which contributes water to the lake is the **watershed**. The watershed may be large or small when compared to the area of the lake. The water may enter the lake from the watershed as streams and rivers, or through the ground as groundwater. The term watershed is used interchangeably with **catchment** or **drainage basin**, although the latter term can imply a larger area containing several watersheds or **sub-basins**. The boundaries of a watershed are defined by ridges and hills that divide or separate water movement into one drainage basin or another. The **lake basin** includes the lake bottom as well as the surrounding slopes.

1.5 Lake Lifespan²

Lakes fill in, drain themselves, or just evaporate and disappear. They do not last forever. Although lakes seem permanent in our human time perspective, they are sediment traps, and it is natural for them to fill in gradually with sand, silt, and organic matter. Natural lake aging or **eutrophication** moves from a nutrient-poor (**oligotrophic**) condition to an intermediate (**mesotrophic**) stage of nutrient availability and biological productivity, and finally to a nutrient-rich or highly productive (**eutrophic**) state. Eutrophication - the process of nutrient enrichment and basin filling - may take thousands of years, but it can be accelerated greatly by disruptions to the watershed. Human activities that increase nutrient and sediment loadings to a lake are termed **cultural eutrophication** and include forest clearing, road building, construction, and wastewater discharges.

¹ This section is taken from Diet For A Small Lake, Prepared by the New York State Department of Environmental Conservation and the Federation of Lake Associations, Inc., 1990.

² This section is taken from Diet For A Small Lake, Prepared by the New York State Department of Environmental Conservation and the Federation of Lake Associations, Inc., 1990.

Trophic conditions in lakes are relative, not absolute - that is, there is no definitive line between oligotrophic and mesotrophic, or between mesotrophic and eutrophic. However, each trophic state has characteristic conditions. Oligotrophic lakes have a low level of organic productivity, clear water, and low nutrient levels. These lakes often are characterized by deep water and steep basin walls. Water in mesotrophic lakes contains a moderate supply of nutrients and organic production. Eutrophic lakes are characterized by a very high level of nutrients which causes a significant increase in the rate of plant growth. As a result, water clarity is greatly reduced, and oxygen depletion is common during the summer months. Eutrophic lakes tend to be shallow and, typically, have elevated water temperatures.

Identification of a lake's trophic status is a useful way to determine its general "health", or biological status, from one year to the next and in comparison with other lakes. If a potential problem is identified in a lake, the trophic status can also be used to evaluate management alternatives.

A few lakes are naturally eutrophic. Many lakes and reservoirs are located in naturally fertile watersheds where the soil is highly erodible. Unless the soil remains undisturbed, these lakes have little chance of being anything but eutrophic. Users of these lakes need to recognize and accept the fact that manmade systems (such as laws, property, or zoning) may not "correct" the conditions. Residents and visitors should adjust their expectations for the appearance and use of such eutrophic lakes.

1.6 General Lake Issues and Concerns

This section describes some of the most common concerns and issues that have been raised by residents and property owners of the Borough. There are three main categories of lake related concerns and issues. One category is water quality related. Activities within the shoreland area can have a direct impact on lake water quality. A shoreland is the land within 500 to 1,000 feet of the normal mean water mark of a lake or pond. The placement of septic systems in unsuitable soils or too close to the lake or the lack of sanitary facilities at public access points can introduce nutrients and pathogens into the lake. Inadequate soil erosion control during upland construction can increase the loading sediment to the lake. Removal of vegetation along the shoreline or at unsupervised public access points may increase erosion of the bank and loss of its ability to filter runoff.

Another category of concerns and issues is related to the surface use of the lake. Some uses may conflict with one another such as fishing and water-skiing because it is difficult for both activities to occur at the same time and in the same location. Other uses cause conflicts by the nature of how the use occurs such as becoming a nuisance by creating noise during sleeping hours. Some uses of the surface water may create shoreline erosion and hence, sediment loading at the lake and loss of private property.

The last category of lake issues regards the impact of recreational use on wildlife and wildlife habitat. Unsuccessful nesting or above average mortality may occur during the nesting season if nests are harassed, frequented by watercraft, or swamped by wave action.

1.7 Rainbow Lake Issues and Concerns

The Rainbow Lake, Lake Management Plan was initiated by a request from Rainbow Lake property owners. A meeting was held with residents and adjacent property owners. At this meeting concerns and issues were discussed.

The issues identified included:

- 1) Noise; and
- 2) Safety; and
- 3) Protection of the wildlife and wildlife habitat; and
- 4) Erosion caused by wakes; and
- 5) Protection of the quiet residential character of the lake; and
- 6) Surface uses that create noise and disturb wildlife are primary concerns of property owners and residents.

It is the desire of the majority of property owners and residents of Rainbow Lake to protect and enhance the low impact, quiet recreational and residential character of the lake. The present state of the lake may be characterized as residential, quiet, with active loon and grebe nests. However, the lake has more recently been used to test large horsepower engines and utilized by personal watercraft. Residents of the area believe these uses are incompatible because they have harassed wildlife, created turbid water conditions, and caused erosion.

2 **Inventory of Existing Conditions**

2.1 Location

Rainbow Lake is located approximately 0.5 miles west of the George Parks Highway at milepost 48.8 and is part of the greater Meadow Lakes community (see Figure 1). Rainbow Lake is accessed by Lakeview Drive via Pittman Road. The Rainbow Lake area is located completely within the boundaries of the Meadow Lakes Community Council (see Figure 2).

2.2 Land Ownership

There are 107 lots within the Rainbow Lake planning area. All parcels of the land adjacent to Rainbow Lake are privately owned. The Borough does not own land in the area and the State owns two lots, each without lake frontage (see Figure 3). A stream or channel connects Rainbow Lake to several northern waterbodies.

Figure 1
Location Map

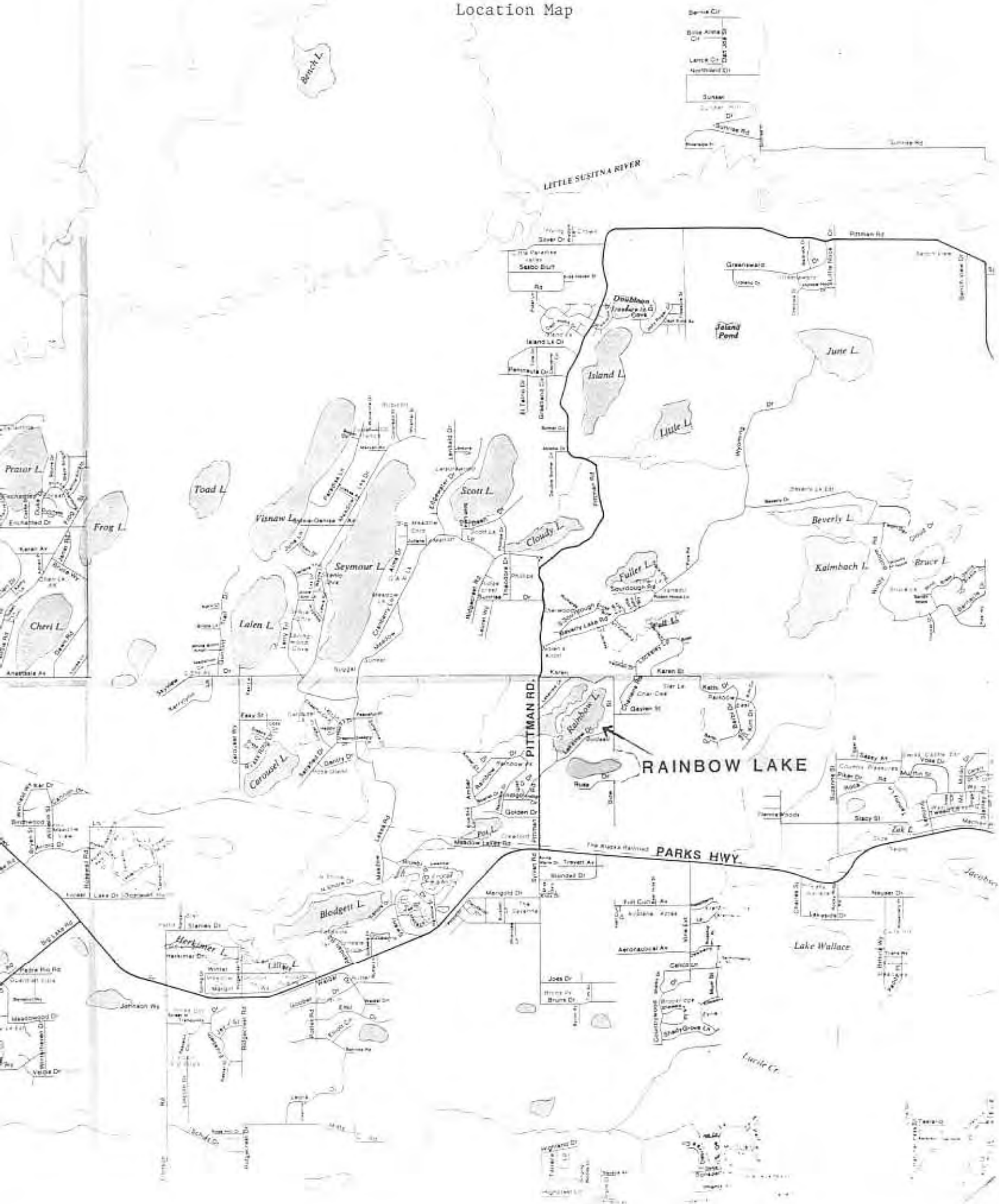
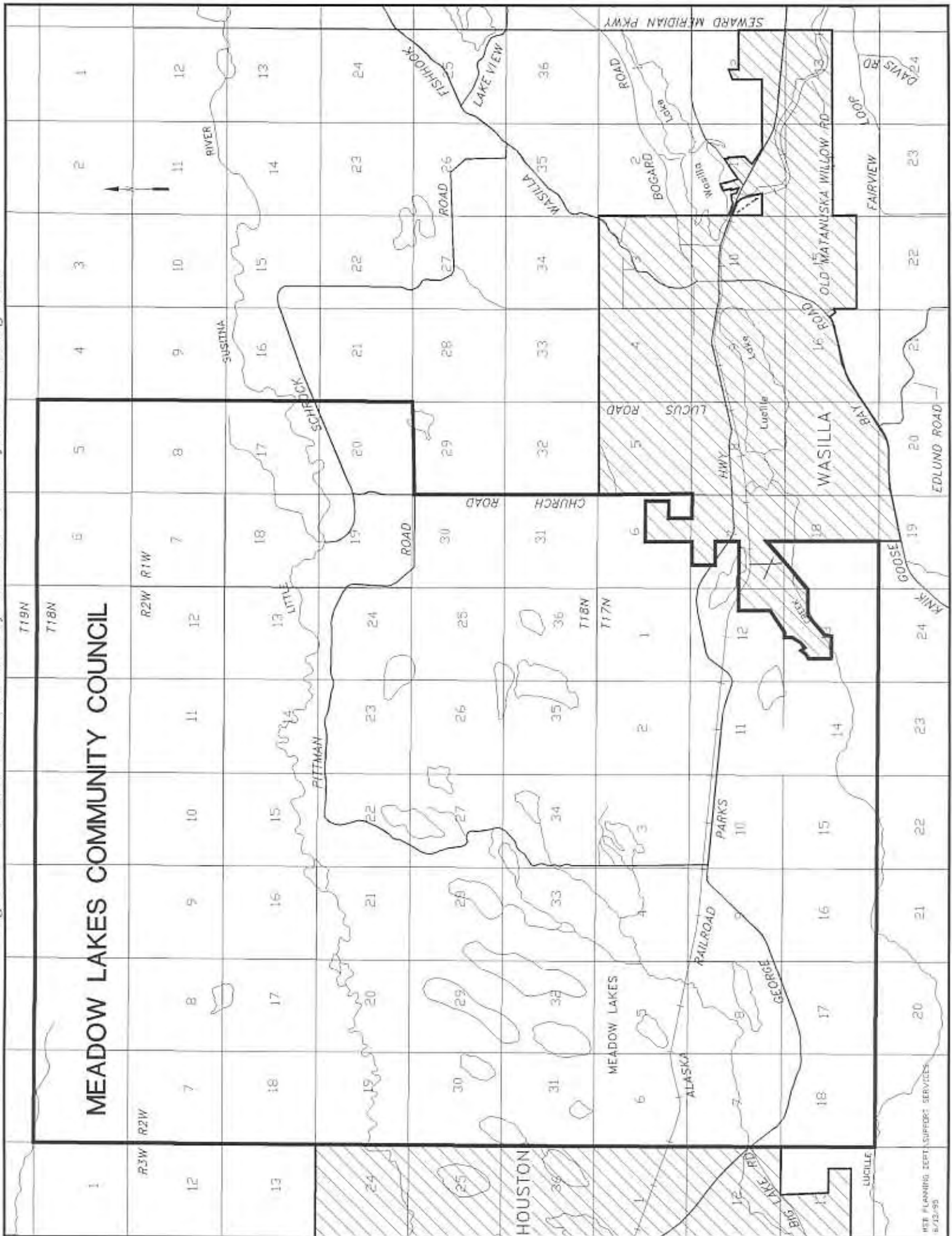
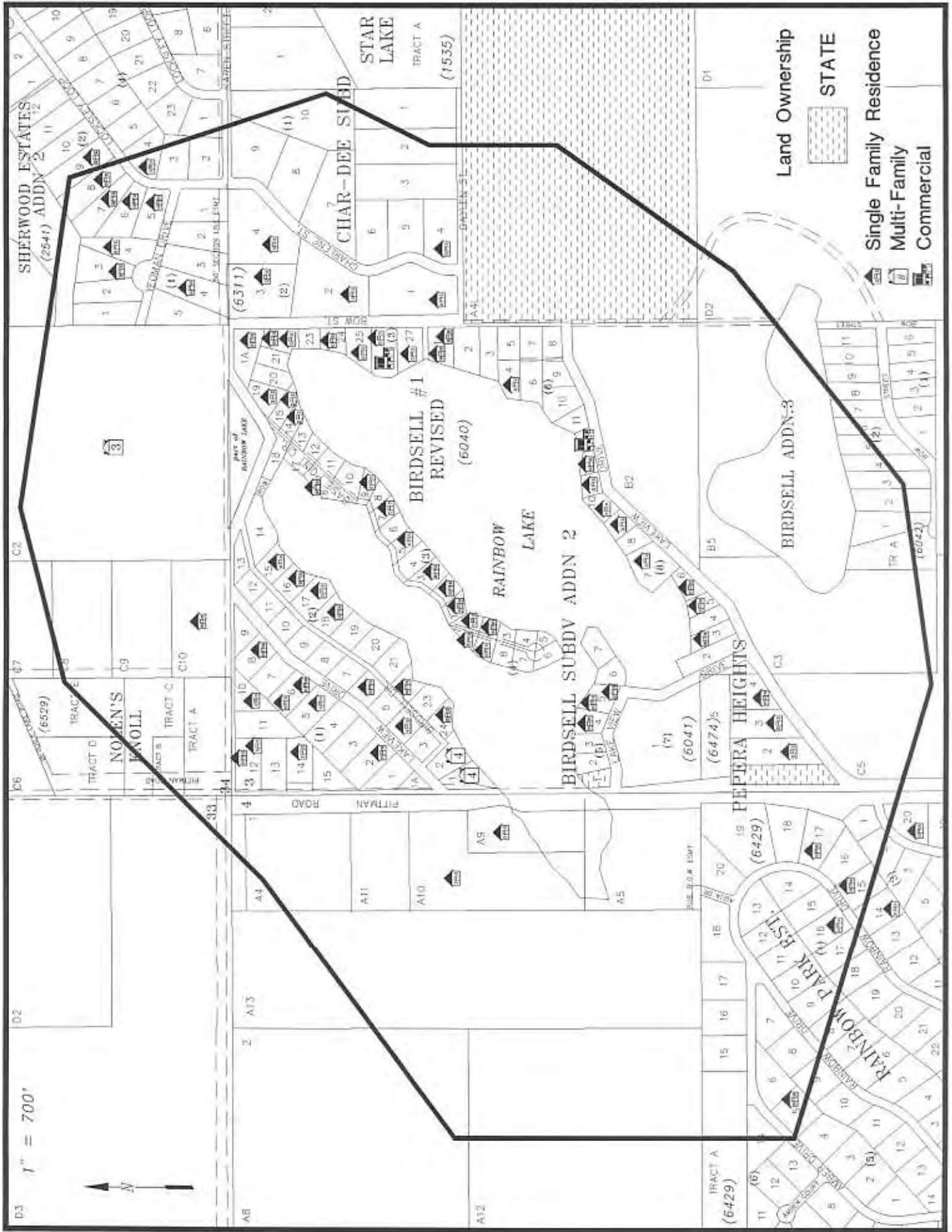

Figure 2 – Meadow Lakes Community Council Boundary and Planning Area





2.3 Existing Plans

State

The State plan affecting the Rainbow Lake area is the Willow Sub-Basin Plan. The Willow Sub-Basin Area plan, adopted in October 1982, contains management intent for State and Borough lands within the Willow Sub-Basin, an area of approximately 1,500 square miles. Rainbow Lake is located within the Wasilla management unit. Generally speaking, the plan's intent for public lands within the management unit is to provide lands for the settlement needs of the general Wasilla area. Lands along the George Parks Highway are to be used to protect the highway's scenic quality.

Borough

Borough plans that address Rainbow Lake in some manner include the Borough-wide Comprehensive Plan, adopted in 1971; the Matanuska-Susitna Borough Coastal Zone Management Plan, as amended, and the Borough-wide Long Range Transportation and Public Facilities plans.

The Borough-wide Comprehensive Plan does not make specific recommendations for either the Rainbow Lake or Meadow lakes areas. Rather, the 1971 plan recognizes that the Meadow Lakes area has important recreational characteristics and that these characteristics will attract visitors and new residents in the future³.

Rainbow Lake lies within the Matanuska-Susitna Borough Coastal District (District), as defined within the Matanuska-Susitna Borough Coastal Management Plan, as amended. The Coastal Management Plan seeks to direct the course of local, state or federal development within the District in a manner that protects the important land and water resources of the District. The adopted policies of the Coastal Management Plan are used to evaluate development proposals vis-a-vis resource values in an effort to ensure that the proposals are consistent with the plan's goals and objectives. Local development includes actions that trigger a Borough subdivision, planning or zoning action. For example, a variance application to build a habitable structure or garage closer than 75 feet from the ordinary high water mark of Rainbow Lake would be reviewed to determine whether or not it is consistent with the Coastal Zone Management Plan. Construction within water bodies are also reviewed for consistency with the plan. Uncovered floating or pile supported docks which do not extend more than 40 feet beyond the ordinary high water line and do not exceed 400 square feet in size may obtain a general concurrence. Metal drums, however, may not be used as floatation devices.

³ Alaska State Housing Authority, Matanuska-Susitna Borough Comprehensive Development Plan, Phase II: Recommendations, 1970.

The Borough Long Range Transportation Plan was adopted in 1987 and is presently being updated. The plan does not identify any new road corridors in the vicinity of Rainbow Lake. Neither of these roads are presently scheduled for construction.

The Borough Public Facilities Plan makes recommendations on a regional basis for the provisions of public services including the development of public facilities necessary to the provision of those services. Services included in the plan include: public safety (fire protection, emergency medical services, and emergency preparedness); library; historical preservation; governmental administration; education; parks, recreation and open space; trails; and utilities. All of these elements affect the Rainbow Lake area in some way, but the Parks, Recreation and Open Space; and Trails elements would have the most impacts relative to the concerns of this management plan.

2.4 Existing Regulations - Public

This section describes the principle regulations affecting use and development in the Rainbow Lake area. This section is **NOT** meant to provide an all encompassing description of all activities and uses that require permits or approvals from local, state or federal agencies. Prior to undertaking any development activity, individuals should contact the appropriate local, state and federal agencies and obtain the required permits and approvals.

Federal

Any work which results in the dredging or placing of structures or fills in tidal (ocean) waters, streams, lakes or wetlands requires a 404 permit from the U.S. Army Corps of Engineers.

Migratory birds, which include loons and grebes are protected by the Migratory Bird Treaty Act. The Act, among other things, prohibits the "take" of migratory birds where "take" is defined to mean pursuing, killing, etc., migratory birds. Destruction of nest sites, eggs or the birds themselves is a violation of the Act.

State

The Alaska Department of Environmental Conservation (DEC) provides regulations for waste water disposal. DEC waste water/septage regulations [18 AAC 72,015(f)] state that no holding tank, septic tank, soil absorption system, seepage pit, privy or other waste water collection, treatment, or disposal system may be within 100 feet, measured horizontally, of the mean annual high water level of a lake, river, stream, spring, slough, or the mean higher high water level of coastal waters.

In addition to the U.S. Army Corps of Engineers 404 permit requirements, any activity within streams and certain work within lakes requires a Title 16 permit from the Department of Fish and Game. Activities which result in the construction of a dam which impounds water or places a weir, culvert or temporarily blocks a stream requires a Title 16 permit. In February, 1994 the Habitat and Restoration Division of Fish and Game issued a one year, general permit allowing the vehicle movement on frozen water surfaces in southcentral Alaska. The permit allows certain motorized vehicles less than 2,000 pounds gross vehicle weight and wheeled vehicles less than 10,000 pounds gross vehicle weight to travel upon frozen water surfaces in southcentral Alaska without a special permit. Finally, the general Alaska Department of Fish and Game fishing regulations apply to Rainbow Lake.

Navigable and public waters in Alaska have special public access requirements. A navigable or public waterbody includes water suitable for commercial navigation, floating of logs, land and takeoff of aircraft, and public boating, trapping, hunting waterfowl and aquatic animals, fishing or other public recreational purposes. Rainbow Lake meets the definition of a public water body. Alaska statute (AS 38.05.128) requires that the public have access to the surface waters of any navigable or public waterbody of the State. This requirement is typically called a "to" easement. In addition, all navigable and public water bodies have a 50 foot easement along the water body; this easement is typically called an "along" easement. In regards to the actual ownership of the lands, the boundary between private and public ownership is the ordinary high watermark of a waterbody or watercourse. Therefore, an "along" easement may be used for transportation or emergency landing purposes but not for overnight camping. These easements are created when the State or Borough obtains patents to their lands and continue with the property when either entity disposes of lands.

Borough

Several Borough-wide ordinances address the development and use of land adjacent to Rainbow Lake. The regulations are contained within the Borough's planning (Title 15), subdivision Title 16, zoning (Title 17) and real property management (Title 23) ordinances. The adopted Coastal Management Plan described earlier, because of its enforceable criteria, also regulates development activities within and near Rainbow Lake.

Title 15 establishes and describes the general functions of the Planning Commission (both planning and zoning functions) and Board of Adjustment and Appeals. Title 15 also describes the comprehensive plan and purposes. Once adopted, the Rainbow Lake, Lake Management Plan will become an instrument of Borough policy similar to the other plans adopted by the Borough Assembly.

Title 16 provides the subdivision development standards within the Borough and establishes the Platting Board. Two of Title 16's requirements that are of special note to development at Rainbow Lake include a minimum lot size of 40,000

square feet, and a minimum lot width when measured at the lake's water line of one hundred twenty-five feet unless community septage is provided, then the minimum width may be eight-five feet (see Figure 4).

The Borough has a Borough-wide comprehensive plan which is implemented, in part, through the Borough-wide zoning ordinance. Presently, the Borough undertakes its comprehensive planning on a community by community basis. As most comprehensive plans are implemented through a zoning ordinance, a number of different zoning ordinances exist within the Borough and are identified as Special Use Districts. For example, the cities of Houston, Palmer and Wasilla all have their own comprehensive plans and all have zoning ordinances unique to their cities. Title 17 contains these various zoning ordinances of the Borough. A list of Title 17's chapters follows.

- 17.01 Acknowledgement of Existing Land Use Regulations.
- 17.03 Public Notification.
- 17.04 Nancy Lake State Recreation Area Special Land Use District.
- 17.08 Hay Flats Recreation Area Special Land Use District.
- 17.12 Palmer Special Land Use District.
- 17.17 Denali State Park Special Land Use District.
- 17.29 Flood Damage Prevention.
- 17.36 Residential Planned Unit Development.
- 17.40 Houston Land Use Ordinance.
- 17.45 Wasilla Special Use District.
- 17.48 Mobile Home Park Ordinance.
- 17.52 Residential Land Use District.
- 17.55 Setbacks and Screening Easements.
- 17.56 Violations and Enforcement.
- 17.57 Non-conformities.
- 17.58 Regulation of Motorized Use of Certain Lakes and Waterways.
- 17.60 Conditional Uses.
- 17.65 Variances.
- 17.70 Regulation of Alcoholic Beverage Uses.
- 17.90 Regulation of Adult Oriented Businesses.
- 17.99 Fees.

Zoning regulations that are of special note to development activities at Rainbow Lake include setback requirements and a petition process to limit or eliminate motorized use of lakes and conditional use permits. Presently all structures must be a minimum of twenty-five feet from a right-of-way and ten feet from all lot lines. In addition, the voters of the Borough approved by initiative, a requirement that all habitable structures and garages must be located at least seventy-five feet from the ordinary high water mark of any waterbody or watercourse (see Figure 4). In 1994, the voters of the Borough also adopted by initiative, an ordinance that allows by petition and subsequent adoption by the Assembly the following restrictions to be placed on lakes and waterbodies: 1) limiting or elimination of motorized use of lakes, 2) establishment of quiet hours

Figure 4

General Setback Requirements and Lot Size* Requirements

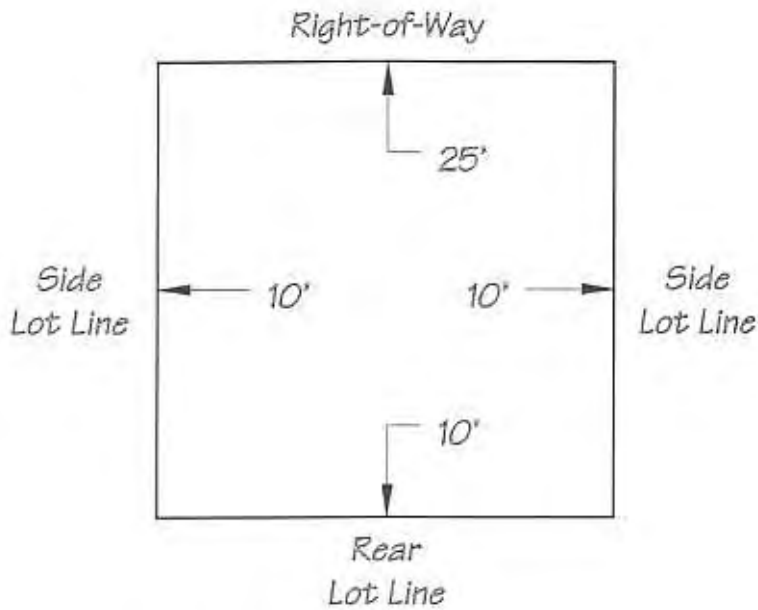

Ordinary High Water Line
of Lake (no community septage)

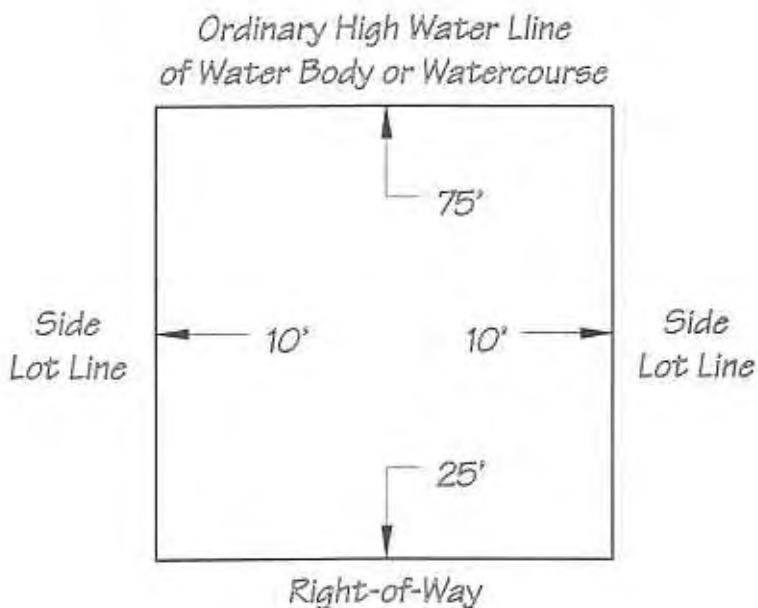
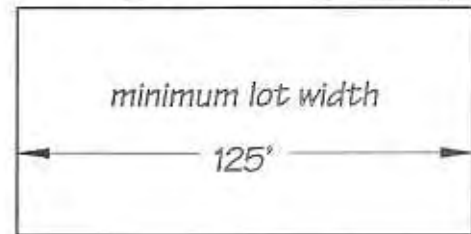

Ordinary High Water Line of
Lake (community septage available)

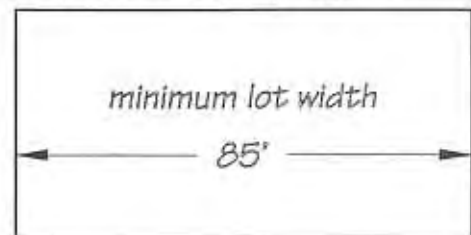

*All lots must be a minimum of 40,000 sq. ft.

and 3) establishment of a one hundred foot no wake zone from the ordinary high water mark. The Borough also requires that any development which seeks to establish or operate a mobile home park, junkyard, refuse area or landfill, or dispense alcohol must first obtain a conditional use permit.

The Borough received approximately 350,000 acres of land through the Municipal Entitlement Program. The Planning Department of the Borough manages and disposes of these lands through the policies and procedures described within Title 23. As of December, 1994, the Borough did not own any land within the Rainbow Lake area.

Existing Regulations - Private

No private regulations exist in the Rainbow Lake area as no subdivision covenants have been recorded. For current information about covenants in the area, the reader is referred to the State of Alaska Records Office.

2.5 Present Lake Usage

Rainbow Lake contains 72.3 surface acres with two peninsulas and has just over 2.7 miles of shoreline. Rainbow Trout are found in the lake and the lake contains active grebe and loon nests.

The present use of Rainbow Lake may be characterized as being low-impact recreational and the property immediately adjacent to the lake is residential in character. Residents live at the lake throughout the entire year. Lake front property owners are the predominant users of Rainbow Lake. They boat, swim and fish at the lake. The use of personal watercraft (jetskis) has recently occurred at Rainbow Lake and the lake has been used to test boat motors. As the lake is shallow and narrow, the use of personal watercraft and large motors have created erosion of the shoreline, turbidity, and loss of wildlife.

Residents have indicated that the lake is used by visitors for boating and fishing. Some visitors access the lake from the public access point located northeast of the lake where a right-of-way connects Rainbow Lake to Lakeview Drive. Some visitors have been reported to camp at the site which lacks sanitary and camping facilities and trash receptacles resulting in unsanitary conditions.

3 **Goals**

Goals describe the future expectations of residents, property owners, and users for a lake. The following goals reflect the aspirations of Rainbow Lake residents, property owners, and users and address their principal concerns: water quality, access, wildlife, quality of experience, and the recreational character of the area. The goals are not shown in priority order as they are interdependent.

3.1 Water Quality

Rainbow Lake is a significant natural resource and it is the desire of property owners, residents and users of Rainbow Lake to maintain or improve the lake's water quality.

3.2 Recreation and Residential Character

The recreational opportunities offered at Rainbow Lake should be maintained and enhanced but suited to the lake's particular characteristics and should not detract from the quality of experience at the lake.

Rainbow Lake offers a unique setting for part and full time residential use and this quality should be protected and preserved.

Upland development should occur in an appropriate manner to ensure that pollution, noise or other environmental degradation of the lake and uplands does not take place.

Uses of the lake should be compatible or enhance the present character of the lake which is of a low-impact, quiet recreational character.

3.3 Wildlife

The ability of Rainbow Lake to remain a migratory bird (loon and grebe) nesting site should be preserved. Recreational use of the lake should be compatible with wildlife nesting.

3.4 Access

Legal and physical access to the lake should be assured for all members of the public.

Public access should be properly managed and measures should be developed to maintain its safety, cleanliness, sanitary nature and to ensure that the area remains open to all.

4 **Management Issues, Alternatives and Recommendations**

The management issues at Rainbow Lake were identified by the lake's property owners and residents. This section describes several methods for alleviating problems and provides preferred recommendations. The alternatives were developed through discussions with property owners and residents, and a review of how other lakes in the Borough are managed and how lakes in other states have been managed.

4.1 Access

Management Issue Presently there are three legal and physical methods of access to Rainbow Lake. All three access points are overland and consist of road right-of-way connecting to the lake. Access to Rainbow Lake is necessary for recreation purposes. Access must also be provided to the lake to fulfill the State's legal requirement of providing public access to a public water body. The public's access through the channel has created problems, such as, overnight camping, litter and unsanitary conditions.

Alternatives When considering management alternatives related to public access more must remember that legal and physical access is necessary for Rainbow Lake in order to comply with Borough and State regulations.

In regards to the public access management, three alternatives present themselves: 1) do nothing, 2) vacate the right-of-way, or 3) actively manage the right-of-way. The first alternative must be discarded because the lack of management will allow unsanitary conditions to continue. Moreover, doing nothing would also allow environmental degradation to continue. The second alternative must be eliminated as public access must be maintained to Rainbow Lake. The third alternative, active management, could eliminate the present problems by providing members of the public with information about the allowable uses on Rainbow Lake as well as by providing personnel to convey this information or report violations.

Recommendation Of the three alternatives, the third alternative, active management, is the recommended course of action. The Borough will seek to actively manage the sites by providing public awareness information at the access points to the lake. "No Overnight Camping and No Open Fires" signs should also be placed at the access sites. A weather protected signboard should be placed at the site to provide information about the lake, birdlife and general "rules of the area" and could be reviewed by all. The information at the signboard should also identify where nearby overnight camping is permitted.

4.2 Wildlife

Management Issue The principle wildlife of concern to Rainbow Lake residents and property owners is the retention and protection of loon and grebe nesting sites. Presently the lake has active nests and there is a concern that increased motorized activity on the lake will harm the existing nesting sites. The remainder of this section will discuss alternatives for preserving and protecting the grebe and loon nests.

Loon nesting sites and successful breeding may occur on lakes having development and recreational use if sufficient habitat is available and the nesting sites are not repeatedly disturbed. Loons will nest on shore although islands offer

the optimal nest sites. Nesting periods generally begin in late May through late June, however, if a nest is abandoned a loon pair may attempt a new nest and this second nesting period runs through late July. In order to retain and protect the existing nest site, lake users need to become informed of how recreation and development affects loons, as well as avoid the nest site during the critical nesting/mating/rearing periods. While grebes commonly have the same breeding period as loons, grebe nest sites are much different. Grebes prefer to nest on floating objects, typically vegetation.

Nest sites and breeding may be disturbed in a number of ways. Steady activity that comes near a nest site, whether motorized or non-motorized, may cause the nest to be abandoned. High motorized activity near a nest site may cause chick mortality due to separation from the adult or wakes caused by motorized craft may destroy the nest or wash away the eggs. In addition to damaging a nest, activities occurring too close to a nest will cause loons to leave an active nest thereby allowing predators such as gulls and ravens to eat the unprotected eggs or chicks. Discarded mono-filament line presents another threat to loons and other birds as it may entangle birds and chicks and ultimately kill them through starvation predation, or by drowning.

Alternatives If nothing is done to inform lake users of the sensitivity of loons and grebes to water borne activities and development, active nests will not be found on Rainbow Lake in the future. In order to maintain the presence of loons and grebes it is necessary that some proactive steps be implemented.

Recommendations Most individuals will not disturb a nest site if they are informed of its location and the proper behavior when near it. It is recommended that a number of techniques be employed to provide the public with information about loons and grebes. First, existing nests where regular loon or grebe nests have occurred should be encircled by a number of buoys marked with "Loon (or Grebe) Nesting Site - Do Not Approach" placed at least 150 feet (200 feet preferred) from the nest's boundary. Appendix #1 provides an illustration of a low cost, effective buoy. Loon and grebe alert notices and general information about loons should be posted at a weather protected signboard at the lake's access point to inform the public about proper "loon or grebe etiquette" (see Appendix #1).

Since Rainbow Lake is a narrow and shallow lake it is very easy to create wakes and turbid conditions. Wake action may cause grebe/loon mortality by swamping active nests or by separating parents from chicks. Turbid waters reduce fish stocks. Therefore, it is further recommended that a 10 horsepower limit be placed on watercrafts using Rainbow Lake in order to reduce wakes, turbidity, and shoreline erosion.

4.3 Noise

Management Issue Rainbow Lake has a history of low-impact, quiet recreational

use. Residents and property owners of the area wish to maintain these characteristics of the lake. Additionally, Rainbow Lake is a relatively small, shallow, and narrow lake and therefore not of sufficient size to adequately support watercraft with large motors, nor recreational use that generate a large number of wakes.

Alternatives Three alternatives may be considered for this management issue; namely: 1) do nothing, 2) prohibit all motorized use, 3) limit the size/power of motors that may be used on the lake, and 4) establish quiet hours to allow motorized use which does not detract from the current use and character of the lake.

The first alternative, "Do Nothing" ignores problems that may be associated with noise. The "Do Nothing" alternative also ignores one of the primary reasons residents and property owners requested that a lake management plan be developed. This alternative is therefore rejected.

The second alternative would prohibit all motorized use of the lake. While this alternative would eliminate noise associated with motors it would also restrict craft that do not generate noise such as boats with electric motors. A complete ban on motorized use would also eliminate uses that are not associated with the noise problem.

A third alternative is to combine the use of quiet hours with limits on the type of motors allowed to use the lake. The use of quiet hours creates a period of time during the day when motorized use that creates wakes or is repetitive in nature is prohibited. Quiet hours also allow use of the lake during the quiet hour period for quiet, unobtrusive transit of the lake for trolling/fishing.

Recommendation Residents and property owners of the area initiated the lake management planning process, for among other concerns, to protect the existing quiet, low-impact recreational use of the Rainbow Lake. It is therefore recommended that quiet hours be established during the hours of 10 p.m. to 8 a.m. Sunday through Saturday. In addition, it is recommended that the lake be restricted to motors only 10 horsepower or less in size.

5.0 Implementation

Plans may be implemented in a number of ways but are typically implemented through capital improvement programs and subdivision and zoning ordinances. Within the Borough, residents may also petition for motorized use restrictions on lakes and this ordinance may be used to implement a lake management plan. This ordinance was discussed by Rainbow Lake property owners and found not to be needed at this time. Plans may also provide for private implementation through public information campaigns and a list of best management practices that may be used by the public. The problems facing Rainbow Lake at this time do not warrant a special zoning or subdivision ordinance nor do they warrant

implementation of the Borough's motorized use of lakes ordinance. Therefore, this plan will utilize a combination of public information and best management practices to implement the plan. The Borough should utilize its citation authority for infractions of the recommended management guidelines of this plan. In addition, a lake management ordinance⁴ may be adopted containing a general provisions section that provides limited guidelines, e.g., wildlife protection, quiet hours, no-wake zones, and bans on overnight camping. The Rainbow area residents and property owners should be contacted to determine whether or not Rainbow Lake should be included in such an ordinance. A description of the implementation proposals follow.

Quiet Hours Rainbow Lake is a rather small lake which is also shallow and narrow and therefore not suitable for large watercraft. Further, the upland development is predominately residential in character. To protect the shoreline and existing quiet, residential character of the area and unobtrusive recreational use, quiet hours should be imposed on the lake during which no repetitive motorized use should occur (electric and trolling motors are allowed). The recommended quiet hours are 10 p.m. through 8 a.m. Sunday through Saturday.

10 Horsepower Limit As stated above, Rainbow Lake is a relatively small, shallow, and narrow lake and not suitable for large watercraft or watercraft with large motors. Residents living adjacent to the lake seek to have their shorelines protected from erosion caused by large wakes. Loon and grebe nesting on a small lake are placed at an increased risk of disturbance from wakes caused by watercraft with large horsepower engines or by use creating repetitive wake action. The historical use of Rainbow Lake has been low impact recreational; residents and property owners wish to continue this character. Therefore a 10 horsepower motor limitation is recommended for Rainbow Lake.

Loons and Grebes To protect loons and grebes it is recommended that a sign (see Appendix #1) be posted on the existing island having an active loon nest. Further, buoys should be placed a minimum of 150 feet (200 feet preferred) around the island to inform lake users of the nest site. Appendix #1 provides information on buoy construction and placement. Finally, a weather protected informational signboard should be constructed at the preferred access point and information about lake usage and proper behavior near active loon nests e.g. "Loon (or Grebe) Alert!" The Rainbow area residents and property owners and Borough should cooperate in implementing the loon and grebe protection program. Additionally, the harassment of loons and grebes and other lake related wildlife such as grebes may become subject to fines under the proposed lake management ordinance described above.

⁴ Note: Due to the diversity of lakes in the Borough and the many requests for lake management plans and guidelines that have been received, a Borough-wide ordinance consisting of a general provisions section containing rules for all lakes, e.g., don't litter and a more specific provisions section containing several lake categories with different guidelines ranging from none to several is being considered.

The parcels used for lake access should be supervised on a regular basis to prevent overnight camping, blockage and unsanitary conditions. A weather protected information sign should be placed at public access sites to inform the public about the rules regarding the use of Rainbow Lake.

Trash and Fireworks Information should be posted at the information signboard at the public access point informing users to pack out what they pack in. Signs should be erected at the access point stating "No Overnight Camping - Do Not Litter".

Firework displays are illegal without a special permit issued by the Borough Planning Department; never-the-less individuals generally display fireworks throughout the Borough. Firework displays create two problems, noise from explosions and trash from the fireworks. Firework displays may also start forest fires. The Borough does not have the resources to actively police the illegal use of fireworks and such use is a low priority for the Alaska State Troopers. However the Borough should advise property owners of the law and inform them to be considerate of their neighbors, avoid polluting the lake with debris and avoid forest fires and disturbance of waterfowl.

APPENDIX #1

SIGN FLOAT FOR LOON NESTS

(NOT LIKELY TO TURN OVER
IN THE STRONGEST WIND)

AERIAL VIEW

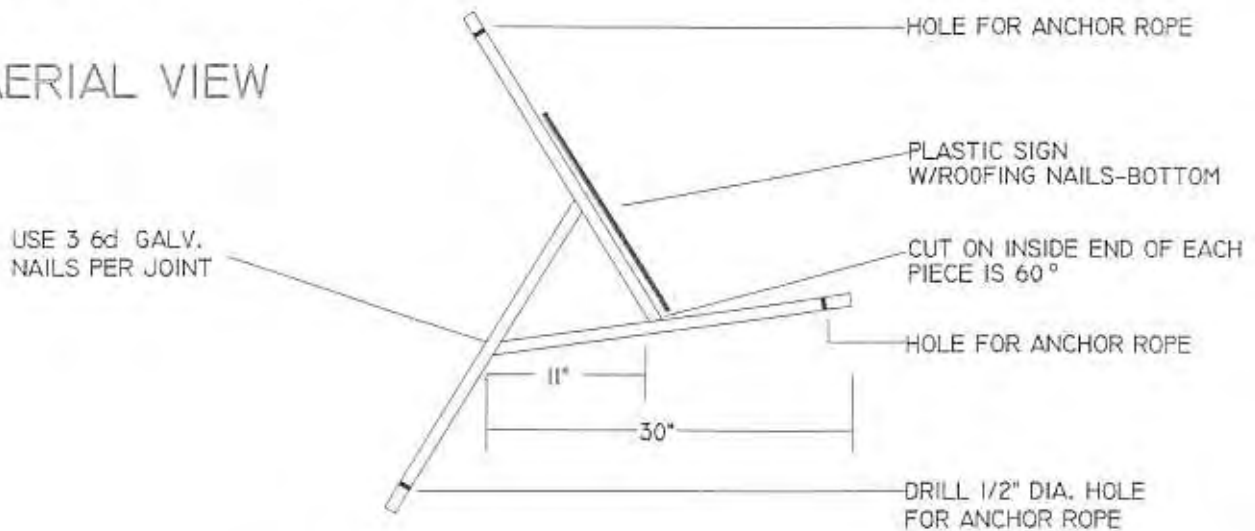

VIEW FROM WATER

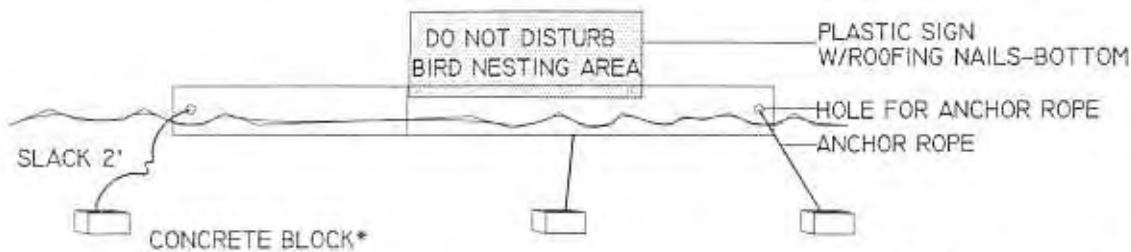

*GALLON MILK JUGS FILLED WITH SAND
COULD REPLACE CONCRETE BLOCKS

NEST

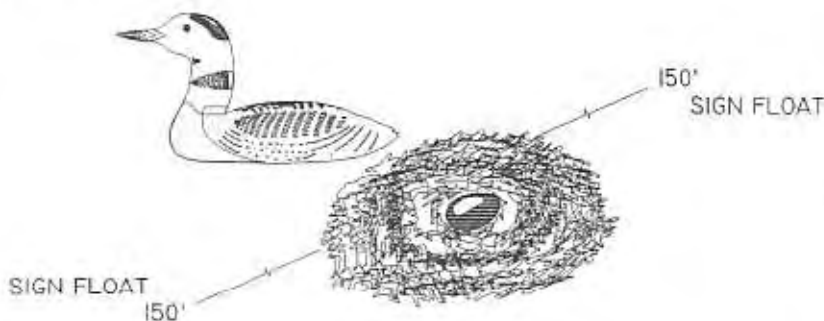

MATERIALS LIST

- 3 - 1"x 4"x 30"
WHITE PINE OR
NO. WHITE CEDAR
- 9 - 6d .GALV BOX NAILS
- 5 - 1" ROOFING GALV. NAILS
- 1 - LOON SIGN
- 2 - 3 CONCRETE BLOCK *
FOR ANCHORS
- ENOUGH 1/4" NYLON ROPE
TO REACH BOTTOM OF LAKE
FOR ANCHOR

The platforms should be attached with two anchors a minimum of 150 feet from the nest (more, if needed to avoid disturbing the loons) and be clearly visible, yet not be a boating hazard. Signs should be removed after nesting is completed (usually by mid-July) each year to preserve their use. Signs should be stored over the winter in a dry area.

LOON ALERT



**Help keep this lake safe
for loons and other wildlife:**

1. Watch loons from a distance.
2. Pick up fishing line and other litter that may entangle loons.
3. Keep your dog on a leash.

Breeding loons have declined or disappeared from other U.S. states due to human disturbance and habitat loss. Wildlife harassment is illegal. Please report violations to Fish and Wildlife Protection (State Troopers) or call (800) 478-3377. For loon information write: Alaska Department of Fish and Game, Division of Wildlife Conservation, 333 Raspberry Road, Anchorage, AK 99518.



STEER CLEAR!

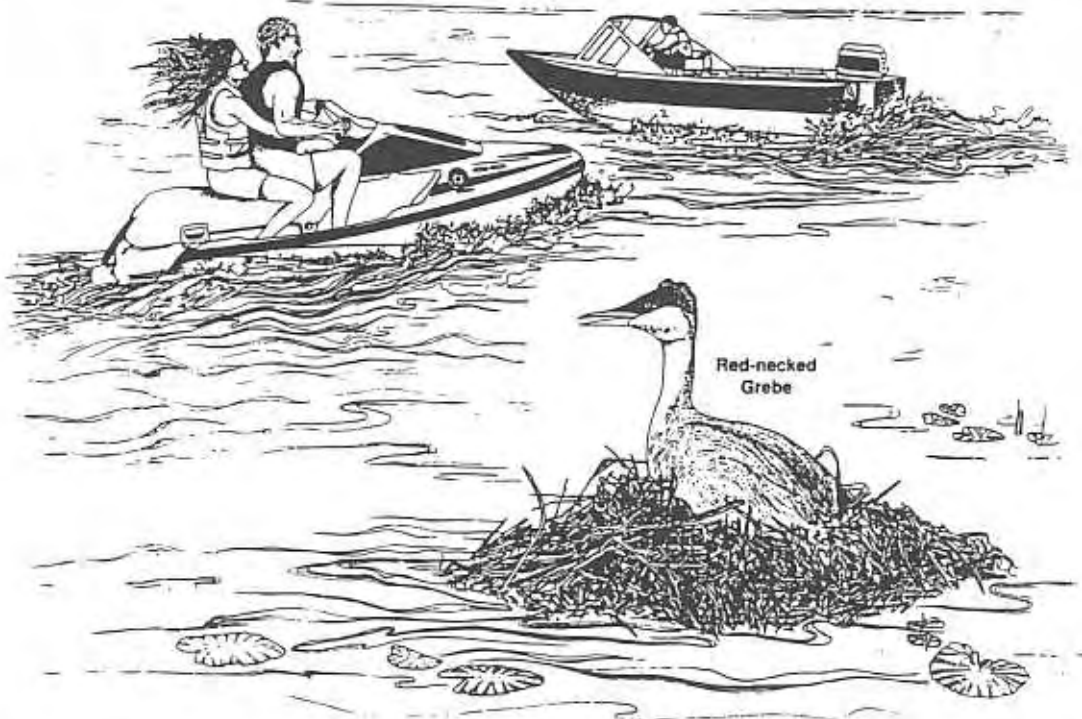

**BOATERS – Stay at least 100 feet away
from nesting Red-necked Grebes.**

**Grebes are duck-sized birds that nest on floating
vegetation and debris in shallow water.**

**Wakes from watercraft will destroy their nests and kill
their eggs and chicks.**

Go slowly along shorelines and avoid nesting areas.

– HELP PROTECT ALASKA'S WILDLIFE –

**Wildlife harassment is illegal. Report violations to Fish and Wildlife
Protection (State Troopers) or call (800) 478-3377.**

**This sign was produced by a grant to the Alaska Watchable Wildlife Trust Fund, c/o Alaska
Conservation Foundation, 430 W. 7th Avenue #215, Anchorage AK 99501 (907) 276-1917.**

POSTED BY ALASKA DEPT. FISH AND GAME

