

WALBY LAKE LAKE MANAGEMENT PLAN

MATANUSKA-SUSITNA BOROUGH
PLANNING DEPARTMENT

SEPTEMBER 1998

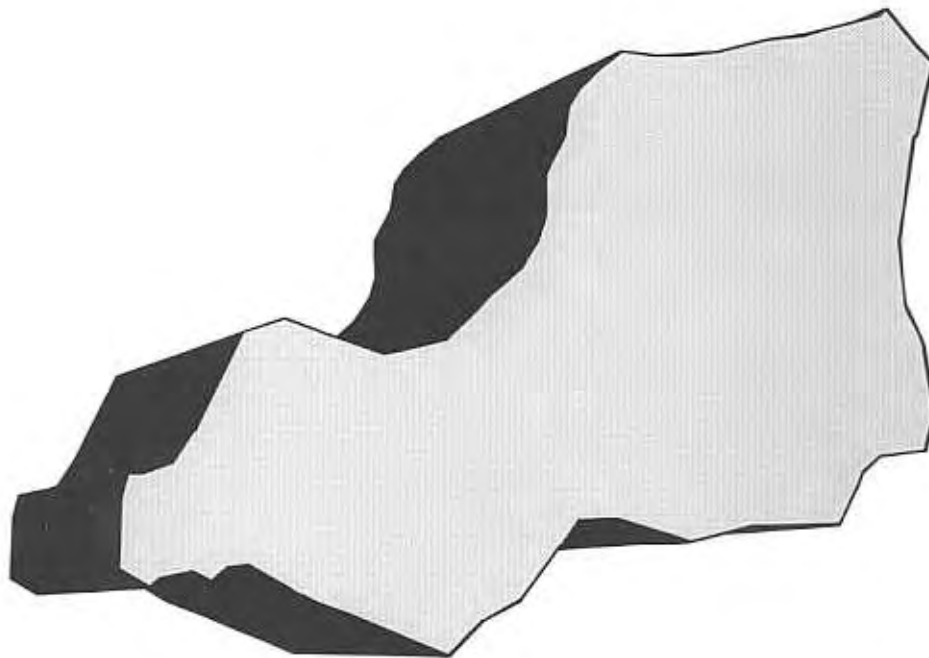

ACKNOWLEDGMENTS

MATANUSKA-SUSITNA BOROUGH ASSEMBLY

Darcie K. Salmon, Mayor

Jim Colberg
Larry DeVilbiss
John Hartrick
Doyle Holmes
Janet Kincaid
Jay Nolfi
Jim Turner

MATANUSKA-SUSITNA BOROUGH PLANNING COMMISSION

Craig Savage, Chair

Fred Agree
Timothy L. Anderson
Jim Colver
Patty Cullison
Dan Kelly
Steve Rowland
Craig Savage

MATANUSKA-SUSITNA BOROUGH

Michael J. Scott, Manager

and

Planning Department Staff

Code Ordinance

By: M. Scott
Introduced: 8/18/98
Public Hearing: 9/1/98
Adopted: 9/1/98

**MATANUSKA-SUSITNA BOROUGH
ORDINANCE SERIAL NO. 98-118**

AN ORDINANCE OF THE MATANUSKA-SUSITNA BOROUGH ASSEMBLY ADOPTING MSB 15.24.030(C)(17), THE WALBY LAKE, LAKE MANAGEMENT PLAN.

WHEREAS, the Walby Lake, Lake Management Plan provides guidelines for the continued enjoyment and management of Walby Lake; and

WHEREAS, the management guidelines for Walby Lake were developed with input from the residents and property owners of Walby Lake; and

WHEREAS, the residents and property owners of Walby Lake seek management guidelines to protect water quality and fish and wildlife habitat, improve safety, and enhance the recreational and residential character of the lake; and

WHEREAS, the Walby Lake, Lake Management Plan will promote the public health, safety and welfare.

BE IT ENACTED:

Section 1. Classification. Section 1, 2, and 4 are non-code ordinance; section 3 is of a general and permanent nature and shall become part of the borough code.

Section 2. Approval of plan. The Matanuska-Susitna Borough Assembly does hereby adopt the Walby Lake, Lake Management Plan.

Section 3. Amendment of subsection. MSB 15.24.030(C) is hereby amended to add a subsection (17) to read as follows:

(17) Walby Lake, Lake Management Plan, adopted September 1998.

Section 4. Effective date. Ordinance Serial No. 98-118 shall take effect upon adoption by the Matanuska-Susitna Borough Assembly.

ADOPTED by the Matanuska-Susitna Borough Assembly this 1st day of September, 1998.

DARCIE K. SALMON, Borough Mayor

ATTEST:

SANDRA A. DILLON, Borough Clerk
(SEAL)

Table of Contents

	Page
1. Introduction	1
1.1 Purpose	1
1.2 Approaches to Lake Management	1
1.3 Process	2
1.4 Ponds, Lakes, and Reservoirs	3
1.5 Lake Lifespan	3
1.6 General Lake Issues and Concerns	5
1.7 Walby Lake Issues and Concerns	6
2. Inventory of Existing Conditions	7
2.1 Location	7
2.2 Land Ownership	7
2.3 Present Lake Characteristics and Usage	10
2.4 Existing Plans	11
State	11
Borough	11
2.5 Existing Regulations	12
Federal	12
State	12
Borough	13
Private	16
3. Goals	16
3.1 Water Quality	16
3.2 Recreation and Residential Character	17
3.3 Wildlife	17
3.4 Access	17
4. Management Issues, Alternatives, and Recommendations	17
4.1 Access	17
4.2 Wildlife	18
4.3 Noise	20
5. Implementation	21
List of Figures	
Figure 1: Lake Characteristics	4
Figure 2: Location Map	8
Figure 3: Land Ownership	9
Figure 4: General Setback Requirements and Lot Size Requirements	15

Appendix #1: State of Alaska, Dept. of Fish & Game, Habitat and Restoration Division

Appendix #2: Bird Nesting Area Buoys, Loon Alert! and Steer Clear! posters

1 Introduction

1.1 Purpose

Lake management plans are developed for a variety of purposes. Most often lake front property owners request management plans because increased development or the provision of new public access brings about increased lake usage and a corresponding increase in user conflicts. As more people use a lake, conflicts among users may occur, bird nesting sites (especially loons and grebes) may be disturbed, environmental degradation may occur, and the overall quality of the experience may decline. The most often cited complaints are noise generated from watercraft during the evening and night hours and inappropriate use of public access points. A lake management plan seeks to present policies and strategies which attempt to balance the various demands placed upon a lake, solve lake related problems, and protect the public health, safety, and welfare.

The Walby Lake, Lake Management Plan provides management guidelines for the following:

- ◆ The protection of the residential quality of Walby Lake
- ◆ The continued recreational enjoyment of Walby Lake
- ◆ The protection of Walby Lake's water quality
- ◆ The continued quiet character and use of Walby Lake
- ◆ The protection and enhancement of fish and wildlife
- ◆ The protection of the public health, safety, and welfare

1.2 Approaches to Lake Management

Motorized Use of Waterbodies There are two approaches that residents and property owners of the Matanuska-Susitna Borough may use to address lake related issues. One approach is to initiate a petition as authorized by 17.58 of the Borough Code. This ordinance, which was adopted by voter initiation in 1994, allows members of the public to seek either a prohibition of all motorized use on a water body or to establish quiet hours (11:00 p.m. to 8:00 a.m.), to establish a 100 foot no wake zone from the shoreline, to require mufflers on all piston driven engines used by watercraft, and to allow special events by permit. Once a petition is filed, a report is drafted by the Department of Planning regarding the suitability of the ordinance for the lake in question and public hearings are then held on the matter by the Planning Commission and Assembly. As of April 1995 this ordinance is in effect for Wasilla, Cottonwood, Mud, and Finger lakes while all motorized use is prohibited on Cottonwood Creek.

Lake Management Plan The other approach that may be utilized for managing a lake is the lake management planning process. A lake management plan is developed with the input of local property owners and residents. The Borough's Department of Planning assists the planning effort by collecting background information, developing maps, etc., but it is the property owners and residents who decide policy issues and develop goals and recommendations. The management planning process also allows a more comprehensive approach to addressing lake related concerns such as how a lake's public access is managed. The lake management planning process also allows property owners and residents to tailor management guidelines to their particular needs and desires.

1.3 Process

Lake management plans are typically initiated by individuals having concerns about a particular lake or who have experienced conflicts between user groups. These individuals request that the Department of Planning (Department) of the Matanuska-Susitna Borough complete a lake management plan. Upon receiving a request to complete a lake management plan, the Department holds an informational meeting where all approaches to managing lake related issues are discussed. At the informational meeting a decision is made by property owners/residents on the preferred approach. The Department then collects the necessary background information on the lake and contacts adjacent property owners and users to participate in the planning process.

Meetings are held with lakefront property owners and users to: 1) identify any problems that may exist, 2) develop a set of recommended alternatives, and 3) consider methods of implementing the recommendations. A draft plan is then developed and a public comment period is held to solicit comments on the draft plan. After the public comment period is closed, comments are reviewed and appropriate modifications made. A meeting may be held with adjacent property owners and users to discuss the comments and proposed modifications. Whether or not this meeting is held depends on the comments received; if the comments call for minor changes or none at all, a meeting is not likely to occur. On the other hand, if the comments seek major changes to the draft plan, a meeting is arranged to discuss the comments and proposed modifications.

After the draft plan has been reviewed by the public and community council, a public hearing on the plan is scheduled with the Borough Planning Commission. At the public hearing anyone may comment on the plan. The Commission considers all oral and written comments received and either recommends to the Assembly adoption of the plan as is, or with modifications, or recommends Assembly disapproval of the plan. After Planning Commission action, the plan is scheduled for a public hearing by the Assembly. The Assembly considers all oral and written comments received and either adopts the plan as is, or with modifications, or disapproves the plan.

1.4 Ponds, Lakes, and Reservoirs¹

There seem to be no universally accepted scientific definitions of the terms **lake**, **pond**, and **reservoir**. In general, waterbodies which have a noticeable flow are termed either rivers or streams. "Ponded waters" have little or no current compared with rivers and streams.

A pond is usually described as a small, shallow body of water, with uniform water temperature from top to bottom. There is little wave action and often, an abundance of aquatic plants. Although local definitions may vary, a pond is generally less than ten acres in area and ten feet in maximum depth.

A lake is usually larger than a pond. It may be quite large and deep, with an abundance of cold water at the bottom. It also may exhibit areas of rocky, wave-impacted shoreline as a result of exposure to prevailing winds. The area of land around the lake which contributes water to the lake is the **watershed**. The watershed may be large or small when compared to the area of the lake. The water may enter the lake from the watershed as streams and rivers, or through the ground as groundwater. The term watershed is used interchangeably with **catchment** or **drainage basin**, although the latter term can imply a larger area containing several watersheds or **sub-basins**. The boundaries of a watershed are defined by ridges and hills that divide or separate water movement into one drainage basin or another. The **lake basin** includes the lake bottom as well as the surrounding slopes.

1.5 Lake Lifespan²

Lakes fill in, drain themselves, or just evaporate and disappear. They do not last forever. Although lakes seem permanent in our human time perspective, they are sediment traps, and it is natural for them to fill in gradually with sand, silt, and organic matter. Natural lake aging or **eutrophication** moves from a nutrient-poor (**oligotrophic**) condition to an intermediate (**mesotrophic**) stage of nutrient availability and biological productivity, and finally to a nutrient-rich or highly productive (**eutrophic**) state (See Figure 1). Eutrophication - the process of nutrient enrichment and basin filling - may take thousands of years, but it can be accelerated

¹ This section is taken from Diet For A Small Lake, Prepared by the New York State Department of Environmental Conservation and the Federation of Lake Associations, Inc., 1990.

² This section is taken from Diet For A Small Lake, Prepared by the New York State Department of Environmental Conservation and the Federation of Lake Associations, Inc., 1990.

Figure 1 LAKE CHARACTERISTICS

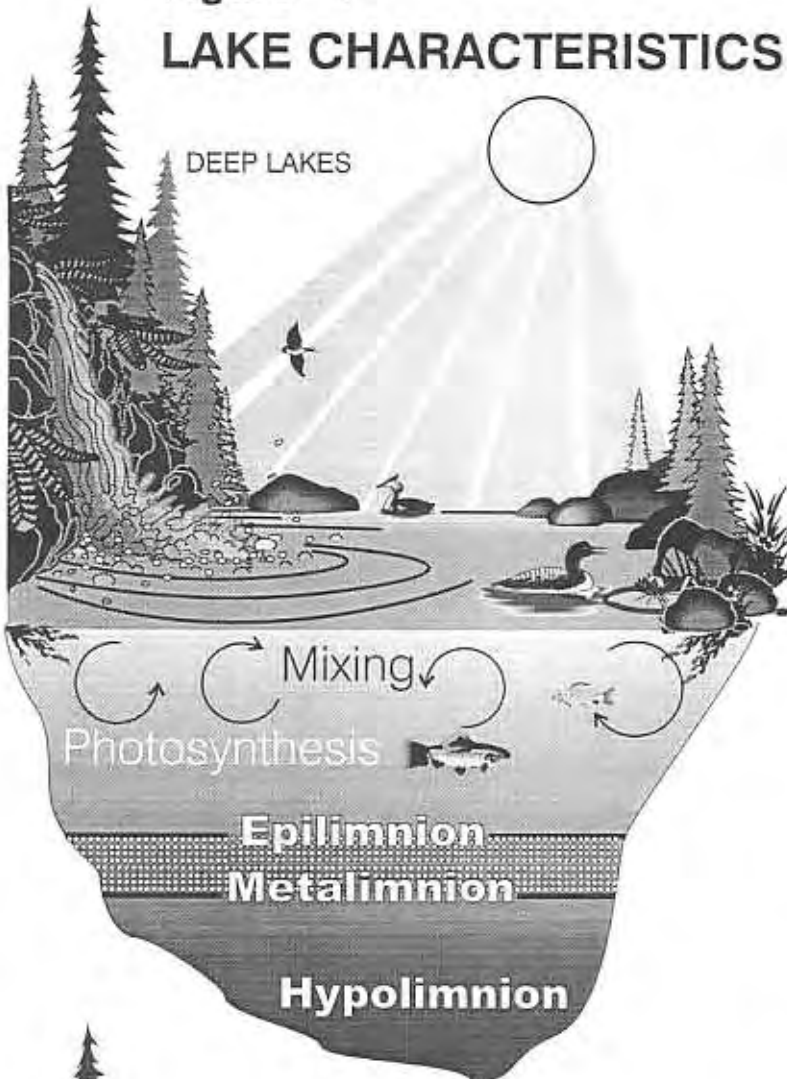

Epilimnion

The upper layer of water in a lake that is comprised of uniformly warm water that may be well mixed.

Metalimnion

The middle layer of water in a lake that marks the transition between top and bottom layers, where temperature changes rapidly with depth.

Hypolimnion

The bottom layer of water in a lake that is comprised of uniformly cold and relatively undisturbed water.

Source: A Citizens Guide
To Understanding and Monitoring Lakes and Streams
By Joy P. Micha



SHALLOW LAKES

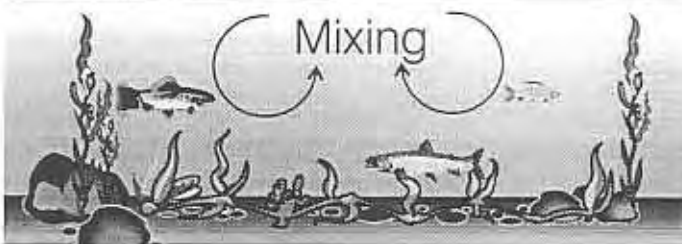

Oligotrophic

Clear water, low productivity
very desirable fishery of large game fish

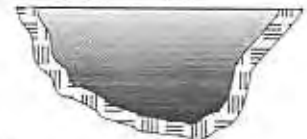

Mesotrophic

Increased production
Accumulated organic matter
Occasional algal bloom
Good fishery



Eutropic

Very productive
May experience oxygen depletion
Rough fish common



Source: A Lake Leaders
Handbook, 1995
UWEX-LAKES PROGRAM
Understanding Lake Data
By Bryan Shaw, Christine
Mächerich and Lowell Klessig

Illustrations.....Planning Department - Support Services
Matanuska-Susitna Borough Palmer, Alaska

greatly by disruptions to the watershed. Human activities that increase nutrient and sediment loadings to a lake are termed **cultural eutrophication** and include forest clearing, road building, construction, and wastewater discharges.

Trophic conditions in lakes are relative, not absolute - that is, there is no definitive line between oligotrophic and mesotrophic, or between mesotrophic and eutrophic. However, each trophic state has characteristic conditions. Oligotrophic lakes have a low level of organic productivity, clear water, and low nutrient levels. These lakes often are characterized by deep water and steep basin walls. Water in mesotrophic lakes contains a moderate supply of nutrients and organic production. Eutrophic lakes are characterized by a very high level of nutrients which causes a significant increase in the rate of plant growth. As a result, water clarity is greatly reduced, and oxygen depletion is common during the summer months. Eutrophic lakes tend to be shallow and typically, have elevated water temperatures.

Identification of a lake's trophic status is a useful way to determine its general "health," or biological status, from one year to the next and in comparison with other lakes. If a potential problem is identified in a lake, the trophic status can also be used to evaluate management alternatives.

A few lakes are naturally eutrophic. Many lakes and reservoirs are located in naturally fertile watersheds where the soil is highly erodible. Unless the soil remains undisturbed, these lakes have little chance of being anything but eutrophic. Users of these lakes need to recognize and accept the fact that manmade systems (such as laws, property, or zoning) may not "correct" the conditions. Residents and visitors should adjust their expectations for the appearance and use of such eutrophic lakes.

1.6 General Lake Issues and Concerns

This section describes some of the most common concerns and issues that have been raised by residents and property owners of the Borough. There are three main categories of lake related concerns and issues. One category is water quality related. Activities within the shore land area can have a direct impact on lake water quality. A shore land is the land within 500 to 1,000 feet of the normal mean water mark of a lake or pond. The placement of septic systems in unsuitable soils or too close to the lake or the lack of sanitary facilities at public access points can introduce nutrients and pathogens into the lake. Inadequate soil erosion control during upland construction can increase the sediment loading of the lake and thereby create turbid conditions. Removal of vegetation along the shoreline or at unsupervised public access points may also increase erosion of the bank and loss of its ability to filter runoff.

Another category of concerns is related to the surface use of the lake. Some uses may conflict with one another such as fishing and water-skiing because it is difficult for

both activities to occur at the same time and in the same location. Other uses may cause conflicts by the nature of how the use occurs such as becoming a nuisance by creating noise during normal sleeping hours. Some uses of the surface water may create shoreline erosion, and hence, increase sediment loading of the lake, and cause the loss of upland property.

The last category of lake issues regards the impact of recreational use on wildlife and wildlife habitat. Unsuccessful nesting or above average mortality may occur during the nesting season of loons and grebes if the nests are harassed, frequented by watercraft, or swamped by wave action.

1.7 Walby Lake Issues and Concerns

The Walby Lake, Lake Management Plan was initiated by a request from Walby Lake property owners. One meeting was held with residents and lakefront property owners. At the meeting, concerns and issues were discussed as well as the proposed lake management plan's guidelines.

The issues identified included:

- 1) The creation of noise, especially in the evening and early morning hours
- 2) Protection of the wildlife and wildlife habitat
- 3) The potential for erosion caused by wakes
- 4) Protection of the quiet, residential character of the lake
- 5) The desire to maintain the 10 horsepower boat motor limit as stated within the subdivision covenants
- 6) The need for proper management of the public access to the lake
- 7) Trash, unsupervised campfires, and environmental degradation at the lake's public access
- 8) Misuse of the public access and lake during the winter months

It is the desire of the property owners of Walby Lake that the quiet, residential, and recreational character of the lake are protected. The present state of the lake may be characterized as having predominantly residential upland development, having a quiet quality, and having active grebe nests. Property owners are concerned that the lake will be used by watercraft with large motors and jetskis/wave runners which are in conflict with the Eagle Estates Subdivision covenants. The increased use of the lake by watercraft with large motors and jetskis/wave runners are believed to create several negative impacts. For example, residents of the area believe use of watercraft with large motors or jetskis/waverunners are incompatible because wildlife is threatened by wakes and noise, turbid water conditions are created as the lake is relatively shallow, shoreline erosion is caused by wakes, noise is generated by the use and by large engines, all of which detracts from the quality of life and recreational experience at the lake.

2 Inventory of Existing Conditions

2.1 Location

Walby Lake is located just east of Trunk Road and is accessed via Tern Drive. (See Figure 2)

2.2 Land Ownership

There are 41 lots with shoreline on Walby Lake (see Table 1). All parcels of land adjacent to Walby Lake are privately owned. The Matanuska-Susitna Borough owns two parcels with shoreline at Walby Lake. The Borough also owns the public access to the lake (see Figure 3).

Table 1
Walby Lake
Landownership and Parcel Size
(lake front only)

	Private	Mat-Su Borough
Number of Parcels	41	2.00
Total Acreage	39.48	15.31
Average Parcel Size		18.26
Smallest Parcel Size		0.50
Largest Parcel Size		14.76

WALBY LAKE
MANAGEMENT PLAN

FIGURE 2



SCALE IN MILES

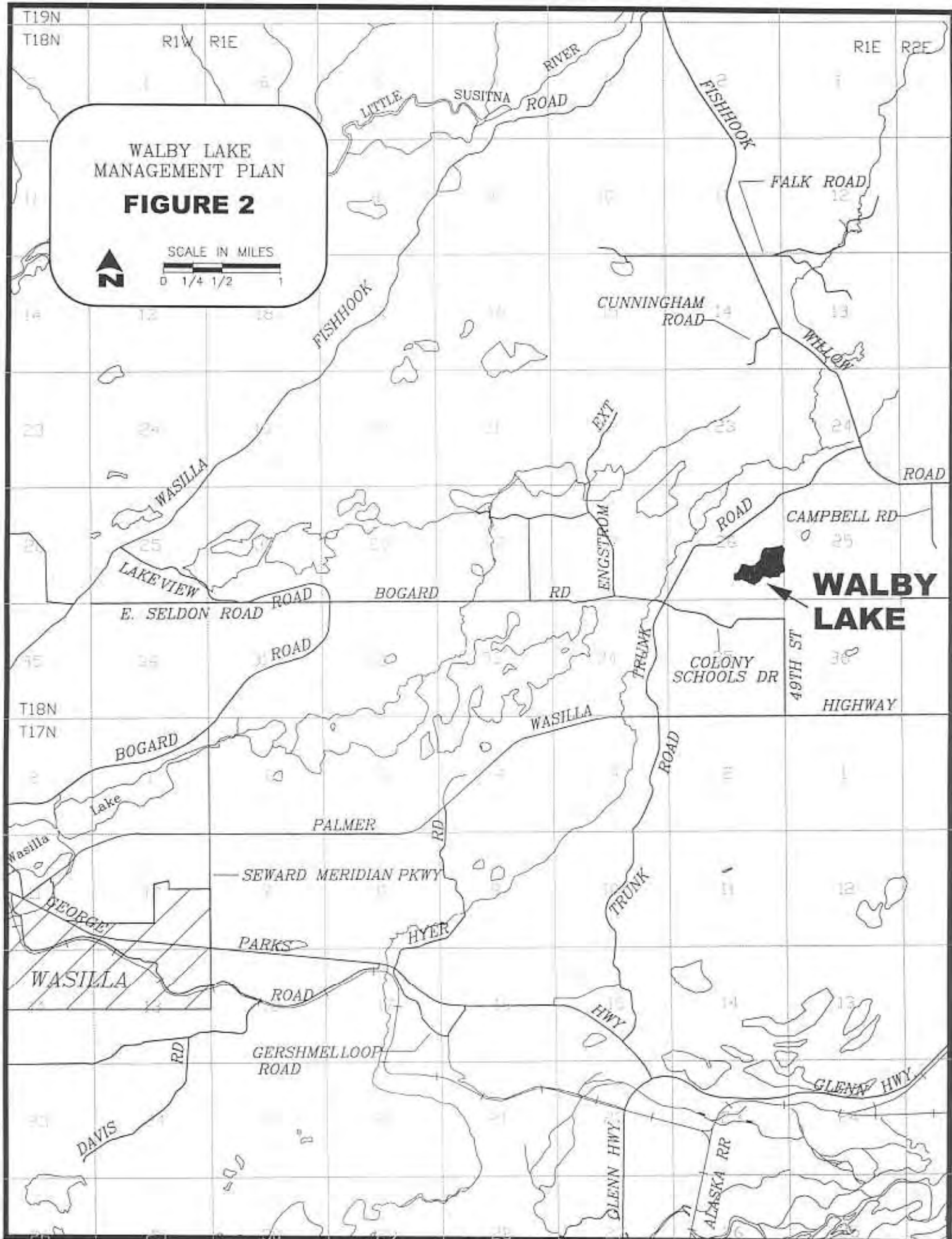
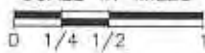

**WALBY
LAKE**

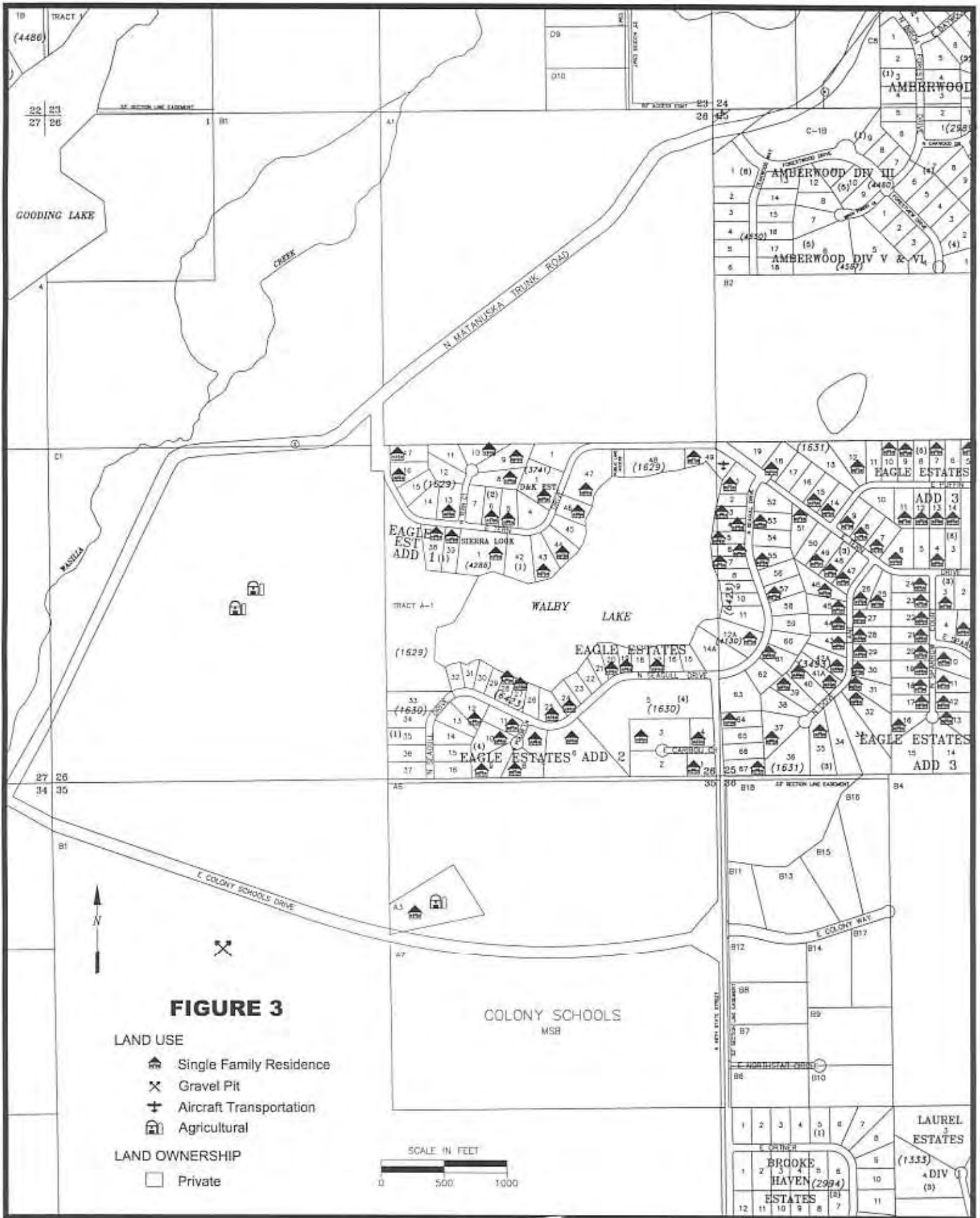

FIGURE 3

LAND USE

- 🏠 Single Family Residence
- ✕ Gravel Pit
- ✈ Aircraft Transportation
- 🏡 Agricultural

LAND OWNERSHIP

- ☐ Private

SCALE IN FEET



2.3 Present Lake Characteristics and Usage

Walby Lake contains about 54 surface acres and has a shoreline length of about 1.4 miles. The lake's volume is 293 acre feet and average depth is 5.4 feet.

Table 2
Walby Lake Characteristics

	Walby Lake
Surface Acres	54
Volume	293 acre feet
Mean Depth	5.4 feet
Maximum Depth	18 feet
Shoreline Length	1.4 miles

Source: State of Alaska, Department of Fish and Game

There is no inlet to the Walby lake. The outlet is located on the western shoreline of the lake. The lake is home to nesting grebes and also serves as resting points for migrating ducks and other waterfowl. Rainbow trout may be found at the lake. Maintaining these fish and wildlife populations is one goal of this lake management planning effort. During the winter, the lake is used for cross country skiing, ice skating, walking and for ice fishing.

The present uplands of Walby Lake may be characterized as quiet, and residential in nature and the property immediately adjacent to the lake consists of residential development. Lake front property owners are the predominant users of Walby Lake. They boat, swim, and fish at the lake. The use of personal watercraft (a.k.a., jetskis/wave runners) is not a regular occurrence at Walby lake because the lake is quite shallow with vegetation. Property owners are concerned that the subdivision covenants that limit watercraft motor size to 10 horsepower will not be adhered to by non subdivision homeowners and that the lake will witness an increased use of personal watercraft and boats with large motors resulting in increased erosion of the shoreline, turbidity, loss of wildlife, and noise and thereby detract from the existing, tranquil use of the lake.

2.4 Existing Plans

State

The State plan affecting the Walby Lake area is the Willow Sub-Basin Area Plan. The Willow Sub-Basin Area Plan, adopted in February 1982 contains management intent for State and Borough lands within the Willow Sub-Basin Planning Area, an area encompassing approximately one million acres. Walby Lake is located within the Wasilla management unit. Generally speaking, the plan's intent for public lands within the management unit is to provide a mixture of land for settlement, public recreation, and habitat protection.

Borough

Borough plans that address Walby Lake in some manner include the Borough-wide Comprehensive Plan, adopted in 1971; the Matanuska-Susitna Borough Coastal Zone Management Plan, as amended; and the Borough-wide Long Range Transportation Plan, Public Facilities Plan and the Core Area Comprehensive Plan.

The Walby Lake area is within the Core Area Comprehensive Planning Area. The Core Area Comprehensive Plan, adopted in September 1993 and amended in November 1994 and September 1997 makes a series of recommendations regarding improving and protecting the land use, transportation and public facilities within the Core Area.

Walby Lake lies within the Matanuska-Susitna Borough Coastal District (District), as defined within the Matanuska-Susitna Borough Coastal Management Plan, as amended. The Coastal Management Plan seeks to direct the course of local, state, or federal development within the District in a manner that protects the important land and water resources of the District. The adopted policies of the Coastal Management Plan are used to evaluate development proposals vis-a-vis resource values in an effort to ensure that the proposals are consistent with the plan's goals and objectives. Local development includes actions that trigger a Borough subdivision, planning or zoning action. For example, a variance application to build a habitable structure or garage closer than 75 feet from the ordinary high water mark of Walby Lake would be reviewed to determine whether or not it is consistent with the Coastal Zone Management Plan. Construction within waterbodies is also reviewed for consistency with the plan. Uncovered floating or pile supported docks which do not extend more than 40 feet beyond the ordinary high water line and do not exceed 400 square feet in size may obtain a general concurrence. Metal drums, however, may not be used as floatation devices.

The Borough Long Range Transportation Plan was adopted in 1987 and has been updated with the adoption of the Long Range Transportation Plan. The Plan

recommends that Trunk Road be widened to four lanes and realigned to remove curves.

The Borough Public Facilities Plan makes recommendations on a regional basis for the provisions of public services including the development of public facilities necessary to the provision of those services. Services included in the plan include the following: public safety (fire protection, emergency medical services, and emergency preparedness); library; historical preservation; governmental administration; education; parks, recreation and open space; trails; and utilities. All of these elements affect the Walby Lake area in some way, but the Parks, Recreation, and Open Space; and Trails elements would have the most impacts relative to the concerns of this management plan.

2.5 Existing Regulations - Public

This section describes the principle regulations affecting use and development in the Walby Lake area. This section is **NOT** meant to provide an all-encompassing description of all activities and uses that require permits or approvals from local, state, or federal agencies. Prior to undertaking any development activity, individuals should contact the appropriate local, state, and federal agencies and obtain the required permits and approvals.

Federal

Any work which results in the dredging or placing of structures or fills in tidal (ocean) waters, streams, lakes, or wetlands requires a 404 permit from the U.S. Army Corps of Engineers.

Migratory birds, which include loons and grebes, are protected by the Migratory Bird Treaty Act. The Act, among other things, prohibits the "take" of migratory birds where "take" is defined to mean pursuing, killing, etc., migratory birds. Destruction of nest sites, eggs, or the birds themselves is a violation of the Act.

State

The Alaska Department of Environmental Conservation (DEC) provides regulations for wastewater disposal. DEC wastewater/septage regulations [18 AAC 72,015(f)] state that no holding tank, septic tank, soil absorption system, seepage pit, privy, or other waste water collection, treatment, or disposal system may be within 100 feet, measured horizontally, of the mean annual high water level of a lake, river, stream, spring, slough, or the mean higher high water level of coastal waters.

In addition to the U.S. Army Corps of Engineers 404 permit requirements, any activity within streams and certain work within lakes requires a Title 16 permit from the Department of Fish and Game. Activities which result in the construction of a dam which impounds water or places a weir, culvert, or temporarily blocks a stream requires a Title 16 permit. In February 1994 the Habitat and Restoration Division of Fish and Game issued a one year, general permit allowing the vehicle movement on frozen water surfaces in southcentral Alaska. The permit allows certain motorized vehicles less than 2,000 pounds gross vehicle weight and wheeled vehicles less than 10,000 pounds gross vehicle weight to travel upon frozen water surfaces in southcentral Alaska without a special permit (Appendix #1). Finally, the general Alaska Department of Fish and Game fishing regulations apply to Walby Lake.

Navigable and public waters in Alaska have special public access requirements. A navigable or public water body includes water suitable for commercial navigation, floating of logs, land and takeoff of aircraft, and public boating, trapping, hunting waterfowl and aquatic animals, fishing, or other public recreational purposes. Walby Lake meets the definition of a public water body. Alaska statute (AS 38.05.127) requires that the public have access to the surface waters of any navigable or public water body of the State. This requirement is typically called a "to" easement. In addition, all navigable and public waterbodies have a 50 foot easement along the water body; this easement is typically called an "along" easement. In regards to the actual ownership of the lands, the boundary between private and public ownership is the ordinary high watermark of a water body or watercourse. Therefore, an "along" easement may be used for transportation or emergency landing purposes but not for overnight camping. These easements are created when the State or Borough obtains patents to their lands and continue with the property when either entity disposes of lands.

Borough

Several Borough-wide ordinances address the development and use of land adjacent to Walby Lake. The regulations are contained within the Borough's planning (Title 15), subdivision (Title 16), zoning (Title 17), and real property management (Title 23) ordinances. The adopted Coastal Management Plan described earlier, because of its enforceable criteria, also regulates development activities within and near Walby Lake.

Title 15 establishes and describes the general functions of the Planning Commission (both planning and zoning functions) and the Board of Adjustment and Appeals. Title 15 also describes the comprehensive plan and purposes. Once adopted, the Walby Lake, Lake Management Plan will become an instrument of Borough policy similar to the other plans adopted by the Borough Assembly.

Title 16 provides the subdivision development standards within the Borough and establishes the Platting Board. Two of Title 16's requirements that are of special note to development at Walby Lake include a minimum lot size of 40,000 square feet, and a minimum lot width when measured at the Lake water line of one hundred twenty-five feet unless community septage is provided, then the minimum width may be eighty-five feet (see Figure 4).

The Borough has a Borough-wide comprehensive plan which is implemented, in part, through the Borough-wide zoning ordinance. Presently, the Borough undertakes its comprehensive planning on a community by community basis. As most comprehensive plans are implemented through a zoning ordinance, a number of different zoning ordinances exist within the Borough and are identified as Special Use Districts. For example, the cities of Houston, Palmer, and Wasilla all have their own comprehensive plans and all have zoning ordinances unique to their cities. Title 17 contains these various zoning ordinances of the Borough. A list of Title 17's chapters follows.

- 17.01 Acknowledgment of Existing Land Use Regulations.
- 17.03 Public Notification.
- 17.04 Nancy Lake State Recreation Area Special Land Use District.
- 17.08 Hay Flats Recreation Area Special Land Use District.
- 17.15 Palmer Special Land Use District.
- 17.17 Denali State Park Special Land Use District.
- 17.18 Chickaloon Special Land Use District.
- 17.19 Glacier View Special Land Use District.
- 17.29 Flood Damage Prevention.
- 17.36 Residential Planned Unit Development.
- 17.40 Houston Land Use Ordinance.
- 17.45 Wasilla Special Use Land District.
- 17.48 Mobile Home Park Ordinance.
- 17.52 Residential Land Use District.
- 17.55 Setbacks and Screening Easements.
- 17.56 Violations and Enforcement.
- 17.58 Motorized Uses on Lakes and Waterways.
- 17.60 Conditional Uses.
- 17.65 Variances.
- 17.70 Regulation of Alcoholic Beverage Uses.
- 17.80 Nonconforming Structures.
- 17.90 Regulation of Adult Businesses.
- 17.99 Fees.

Zoning regulations that are of special note to development activities at Walby Lake include setback requirements and a petition process to limit or eliminate motorized use of lakes and conditional use permits. Presently all structures must be a

FIGURE 4

General Setback Requirements and Lot Size* Requirements

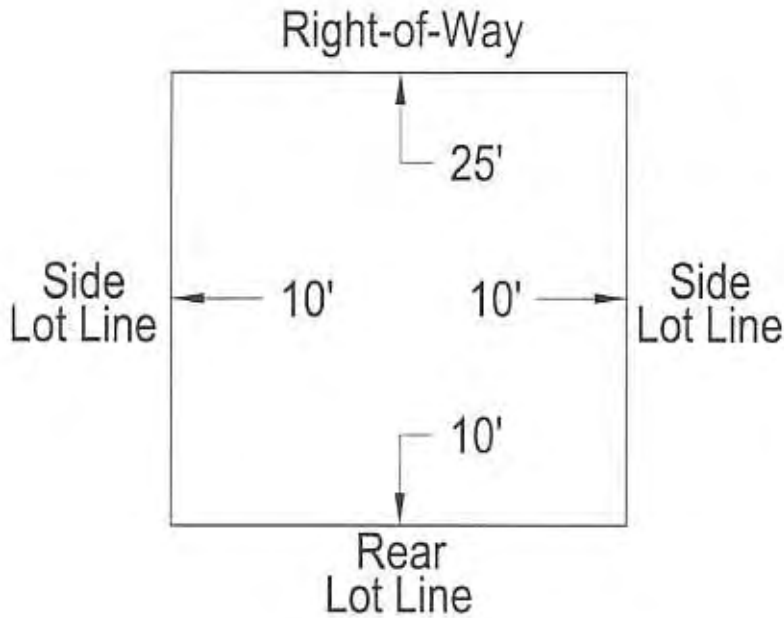

Ordinary High Water Line
of Lake (no community septage)

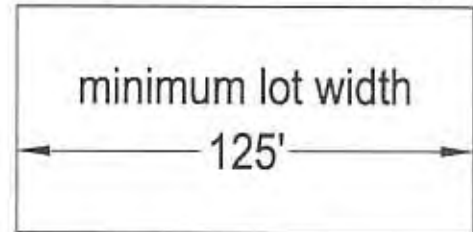

Ordinary High Water Line
of Water Body or Watercourse

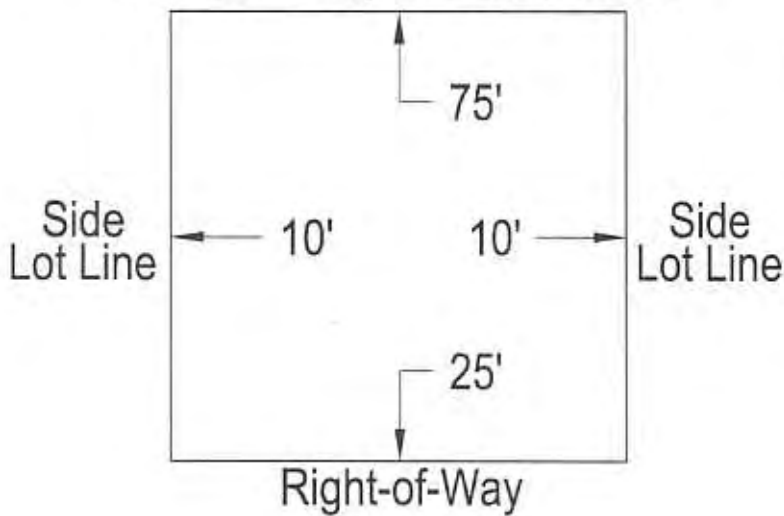

Ordinary High Water Line of
Lake (community septage available)

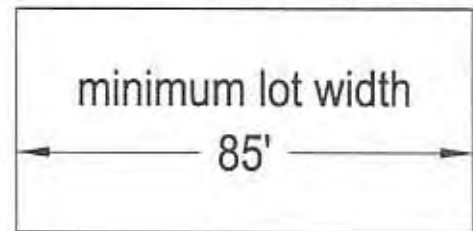

*All lots must be a minimum of 40,000 sq. ft.

minimum of twenty-five feet from a right-of-way and ten feet from all lot lines. In addition, the voters of the Borough approved by initiative, a requirement that all habitable structures and garages must be located at least seventy-five feet from the ordinary high water mark of any water body or watercourse (see Figure 4). In 1994, the voters of the Borough also adopted by initiative, an ordinance that allows by petition and subsequent adoption by the Assembly the following restrictions to be placed on lakes and waterbodies: 1) limiting or elimination of motorized use of lakes, 2) establishment of quiet hours, and 3) establishment of a one hundred foot no wake zone from the ordinary high water mark. The Borough also requires that any development which seeks to establish or operate a mobile home park, junkyard, refuse area or landfill, alcohol dispensary, community correctional rehabilitation facility, motorized racetracks or adult oriented businesses must first obtain a conditional use permit.

The Borough received approximately 350,000 acres of land through the Municipal Entitlement Program. The Planning Department of the Borough manages and disposes of these lands through the policies and procedures described within Title 23. There is one parcel of Borough land located at Walby Lake this parcel serves as the public access to the lake.

Existing Regulations - Private

Private regulations, in the Walby Lake area would be in the form of subdivision covenants for the Eagle Estates Subdivision Additions 1 through 3. The subdivision covenants allow only residential development and has provisions for building setbacks, signs, building quality and size; among other things. The subdivision covenants also restrict the use of Walby Lake to watercraft with motors of 10 horsepower or less. For current information about covenants in the area, the reader is referred to the State of Alaska Records Office.

3 Goals

Goals describe the future expectations of residents, property owners, and users for a lake. The following goals reflect the aspirations of Walby Lake residents, property owners, and users and address their principal concerns: water quality, access, wildlife, quality of experience, and the recreational character of the area. The goals are not shown in priority order as they are interdependent.

3.1 Water Quality

Walby Lake is a significant natural resource and it is the desire of property owners, residents, and users of Walby Lake to maintain or improve the lake's water quality.

3.2 Recreation and Residential Character

The recreational opportunities offered at Walby Lake should be maintained and enhanced but suited to the lake's particular characteristics and should not detract from the quiet quality of experience at the lake.

Walby Lake offers a unique natural setting for residential use and this quality should be protected and preserved.

Upland development should occur in an appropriate manner to ensure that pollution, noise, or other environmental degradation of the lake and uplands does not take place.

Uses of the lake should be compatible, or of the kind that enhance the present quality of the lake which is of a low-impact, quiet, recreational character.

3.3 Wildlife

The ability of Walby Lake to remain a migratory bird (loon) nesting site should be preserved. Recreational use of the lake should be compatible with wildlife nesting.

3.4 Access

Legal and physical access to the lake should be assured for all members of the public.

Public access should be properly managed and measures should be developed to maintain safety, cleanliness, sanitary nature, eliminate trespass and to ensure that the area remains open to all.

4 **Management Issues, Alternatives, and Recommendations**

The management issues at Walby Lake were identified by the lake's property owners and residents. This section describes several methods for alleviating the identified problems and provides preferred recommendations. The alternatives were developed through discussions with property owners and residents, a survey of property owners, and a review of how other lakes in the Borough and lakes in other states have been managed.

4.1 Access

Management Issue Presently there is one developed public access to the lake. Developed points of access that are unsupervised and not managed, more often than not, create numerous problems at lakes throughout the Borough. Examples of the problems caused by the lack of ongoing management of the public access parcels to

lake include the following: trespass onto private property, creation of unsanitary conditions where no sanitary facilities exist, litter, blockage of the public's access by visitor parking or overnight activities, damage to nearby trees, and the potential for land fires from unsupervised campfires. These aforementioned problems exist at Walby Lake. In addition, the somewhat secluded nature of the public access at Walby Lake seems to encourage misuse of the area.

Alternatives Three alternatives were considered to address the access management issue: 1) do nothing, 2) manage the access to the lake as a "primitive" site, and 3) fully develop the public access site. Doing nothing about the lake's public access does not address the present trespass, litter and environmental degradation problems. Additionally, funds are presently unavailable to fully develop the access and provide ongoing operation and maintenance; nor do the residents wish to have this work accomplished. However, some form of management of the public access parcels is necessary to address the existing problems. Managing the public access parcel as a "primitive" site, with limited parking and establishing it as a "Day Use Only" use; is a low cost method that would reduce the existing problems while preserving the ability to develop the parcels more fully in the future should the neighborhood residents so desire.

Recommendation Of the three alternatives, the second alternative, maintenance of a primitive, Day Use Only (8:00 a.m. to 10:00 p.m.) access to the lake is the recommended course of action. The Borough will seek to actively manage the sites by informing users through public awareness information at the entrances to the public access parcels, establishing the parcels as walk-in only, and designating a place for limited parking. "No Overnight Camping and No Open Fires" signs should also be placed at the access sites. A weather-protected signboard should be placed at the site to provide information about the lake, birdlife, and general "rules of the area." The information at the signboard should also identify where nearby overnight camping is permitted.

4.2 Wildlife

Management Issue The principle wildlife concern to Walby Lake residents and property owners is the retention and protection of bird nesting sites, in particular, grebes and terns. Presently, the lake has active nests and there is a concern that increased motorized activity on the lake will harm the existing nesting sites. The remainder of this section will discuss alternatives for preserving and protecting the loon nests.

Loon nesting sites and successful breeding may occur on lakes having development and recreational use if sufficient habitat is available and the nesting sites are not repeatedly disturbed. Loons will nest on shore although islands offer the optimal nest

sites. Nesting periods generally begin in late May through late June, however, if a nest is abandoned a loon pair may attempt a new nest and this second nesting period runs through late July. In order to retain and protect the existing nest site, lake users need to become informed of how recreation and development affects loons, as well as to avoid the nest sites during the critical nesting/mating/rearing periods. While grebes commonly have the same breeding period as loons, grebe nest sites are much different. Grebes prefer to nest on floating objects, typically vegetation.

Nest sites and breeding may be disturbed in a number of ways. Steady activity that comes near a nest site, whether motorized or non-motorized, may cause the nest to be abandoned. High motorized activity near a nest site may cause chick mortality by separating the chick from the adult or by the wakes caused by motorized craft may destroy the nest or wash away the eggs. In addition to damaging a nest, activities occurring too close to a nest will cause loons to leave an active nest thereby allowing predators such as gulls and ravens to eat the unprotected eggs or chicks. Discarded monofilament line presents another threat to loons and other birds as it may entangle birds and chicks and ultimately kill them through starvation, predation, or by drowning.

Alternatives If nothing is done to inform lake users of the sensitivity of loons and grebes to water borne activities and development, active nests will not be found on Walby Lake in the future. In order to maintain the presence of loons and grebes, it is necessary that some proactive steps be implemented. The proactive steps include providing the public with information about waterfowl and bird (loon/grebe) nesting habits and by taking some actions that will reduce the probability of harming nests and nest sites.

Recommendations Most individuals will not disturb a nest site if they are informed of its location and the proper behavior when near it. It is recommended that a number of techniques be employed to provide the public with information about loons and grebes. Loon and grebe alert notice and general information about loons should be posted at a weather-protected signboard at the Lake access point to inform the public about proper "loon or grebe etiquette" (see Appendix #2).

Since Walby Lake is a small and shallow lake it is very easy to create wakes and turbid conditions. Wake action may cause loon mortality by swamping active nests or by separating parents from chicks. Turbid waters also reduce fish stocks. Therefore, it is further recommended that watercraft guidelines similar to the Eagle Estates subdivision covenants, i.e., 10 horsepower boat motor limit be adopted for watercraft using Walby Lake in order to reduce wakes, turbidity, and shoreline erosion and to promote safety.

4.3 Noise

Management Issue Walby Lake has a history of low-impact, quiet, recreational use with surrounding residential development. Residents and property owners of the area wish to maintain these characteristics of the lake. Additionally, Walby Lake is relatively small and shallow and therefore not of sufficient size to adequately and safely support watercraft with large motors, recreational use that generates a large number of wakes or a large amount of surface water activities. The existing subdivision covenants for the land surrounding the lake restrict the lake to watercraft having motors of 10 horsepower or less. The same covenants do not restrict floatplane use nor does this plan recommend any floatplane restriction.

Alternatives Several alternatives were considered for this management issue; these being: 1) do nothing, 2) prohibit all motorized use, 3) establish a limit size/power for watercraft motors that may be used on the lake.

The first alternative, "Do Nothing," ignores problems that are associated with noise and safety and also one of the primary reasons residents and property owners requested that a lake management plan be developed, that being, to control noise. This alternative is therefore rejected.

The second alternative would prohibit the use of all boat motors which conflicts with the desire of residents and property owners and the subdivision covenants. This alternative is therefore rejected.

The subdivision covenants at Walby Lake restrict the motorized watercraft use of the lake to motors of 10 horsepower or less. It is the recommendation of the residents and property owners that the existing watercraft horsepower limits apply to all users of Walby Lake.

As an additional noise management tool, residents and property owners wish to establish quiet hours to ensure that noise does not become a continuing problem at the lake. Quiet hours provide a period of time when motorized use that creates wakes or is repetitive in nature is prohibited. Quiet hours also allow use of the lake during the quiet hours period for quiet, unobtrusive transit of the lake and for trolling. The quiet hours period that has been established through lake management planning efforts within the Matanuska-Susitna Borough are either 10:00 p.m. through 8:00 a.m. or 11:00 p.m. through 8:00 a.m.

Recommendation Residents and property owners of the area initiated the lake management planning process for, among other reasons, to protect the existing quiet, low-impact, recreational use, reduce erosion, reduce noise generation, promote safety and enhance the residential quality at Walby Lake. Property owners and residents

therefore recommend the establishment of a 10 horsepower watercraft motor limit and the establishment of Quiet Hours between 10:00 p.m. and 8:00 a.m.

5.0 Implementation

Plans may be implemented in a number of ways but are typically implemented through capital improvement programs and subdivision and zoning ordinances. Within the Borough, residents may also petition for motorized use restrictions on lakes and this ordinance may be used to implement a lake management plan. This ordinance was discussed by Walby Lake property owners and found not to be needed at this time. Plans may also provide for private implementation through public information campaigns and a list of best management practices that may be used by the public. The problems facing Walby Lake at this time do not warrant a special zoning or subdivision ordinance nor do they warrant implementation of the Borough's motorized use of lakes ordinance. Therefore, this plan will utilize a combination of public information and best management practices, and regulations to implement the plan. The plan recommends the use of the Borough's citation authority for infractions of the plan's recommended management guidelines.

In addition, a lake management ordinance³ may be adopted containing a general provisions section that provides limited guidelines, e.g., wildlife protection, quiet hours, no-wake zones, and bans on overnight camping. The Walby Lake area residents and property owners should be contacted to determine whether or not Walby Lake should be included in such an ordinance. A description of the implementation proposals follow.

10 Horsepower Motorized Watercraft Limit As stated above, Walby Lake is relatively small, with vegetation and the upland residential development is controlled by subdivision covenants restricting the use of the lake to watercraft using 10 horsepower or less motors. Residents living adjacent to the lake seek to have their shorelines protected from erosion caused by large wakes and to have non subdivision members included by the same covenant provision. Loons nesting on a small lake are placed at an increased risk of disturbance from wakes caused by watercraft with large horsepower engines or by use creating repetitive wake action. A 10 horsepower watercraft motor limit is therefore recommended for Walby Lake.

Access To minimize environmental disturbance, wildfire potential, and litter, the public access parcel should be managed as Day Use Only, operating hours between 8:00 a.m. and 10:00 p.m., with limited parking provided.

³ Note: Due to the diversity of lakes in the Borough and the many requests for lake management plans and guidelines that have been received, a Borough-wide ordinance consisting of a general provisions section containing rules for all lakes, e.g., don't litter and a more specific provisions section containing several lake categories with different guidelines ranging from none to several may be considered.

Loons and Grebes To protect loons and grebes it is recommended that a weather-protected informational signboard should be constructed at the public access parcels and information about lake usage and proper behavior near active loon nests, e.g., "Loon (or Grebe) Alert!".

Quiet Hours To maintain the existing quiet nature, residential quality, and low-impact use of the lake, quiet hours are established between the hours of 10:00 p.m. and 8:00 a.m. Sunday through Saturday.

Winter Motor Vehicle Control To reduce the potential of water pollution from petroleum products associated with motor vehicles, motor vehicles are prohibited from the surface of the lakes during the winter months or when the lake is frozen. "No Motor Vehicles Allowed on Lakes" should be posted at appropriate places to inform lake users of this prohibition.

Trash and Fireworks Firework displays are illegal without a special permit issued by the Borough Planning Department; never-the-less, individuals generally display fireworks throughout the Borough. Firework displays create two problems, noise from explosions and trash from the fireworks. Firework displays may also start forest fires. The Borough does not have the resources to actively police the illegal use of fireworks and such use is a low priority for the Alaska State Troopers. However, the Borough should advise property owners of the law and inform them to be considerate of their neighbors, avoid polluting the lake with debris, and avoid forest fires and disturbance of waterfowl.

Enforcement Violation(s) of this lake management plan's guidelines, upon adoption of the plan by the Borough Assembly are subject to the citation and remaining remedies that exist for violation of lake management plan implementation guidelines (15.24.030(c)).

APPENDIX #1

STATE OF ALASKA

WALTER J. HICKEL, GOVERNOR

DEPARTMENT OF FISH AND GAME

HABITAT AND RESTORATION DIVISION

333 RASPBERRY ROAD
ANCHORAGE, ALASKA 99518-1599
PHONE (907) 344-0541
FAX (907) 349-1723

FISH HABITAT PERMIT FG 93-II-0803

ISSUED: February 23, 1994
EXPIRES: December 31, 1994

General Public

Re: Vehicle movement on frozen water surfaces within southcentral Alaska

Pursuant to AS 16.05.870(b), the Alaska Department of Fish and Game (ADF&G) has determined that both the public interest and the proper protection of fish and game would be served through the issuance of a general permit (GP) authorizing the use of certain categories of motorized wheeled and tracked vehicles on the frozen waters of various specified rivers, lakes, and streams within the southcentral region (see attached map).

Categories of motorized vehicles covered by this GP include: any wheeled, tracked, or other ground effect motorized vehicles less than 2,000 pounds gross vehicle weight (GVW) such as snow machines, 3 and 4 wheelers, coots, etc.; and wheeled vehicles less than 10,000 pounds GVW. The use of any ground effect motorized vehicle on specified frozen waters: (1) with GVWs other than indicated above; (2) within State of Alaska Refuges, Critical Habitat Areas, or Sanctuaries (see attached maps); (3) by Alyeska Pipeline Service Company (APSC) for activities along the pipeline corridor, or (4) outside of the described area is not allowed, except by individual Fish Habitat Permit, other general permit, or Special Area Permit issued by the ADF&G, Habitat and Restoration Division, or by the State Pipeline Coordinator's Office for the APSC.

This GP does not authorize cross-country movement of equipment on state land or other activities not generally authorized by the Alaska Department of Natural Resources.

Various rivers, lakes, or streams within the described area have been specified as being important for the spawning, rearing, or migration of anadromous fish pursuant to AS 16.05.870(a). They are utilized by salmon and other anadromous fish for spawning, rearing, or migration, and by resident fish species.

In accordance with AS 16.05.870(d), access to, use and crossings of, or egress from any specified waters, as described above, is hereby authorized provided the stipulations contained herein are adhered to.

1. The ice cover shall be of sufficient thickness to support the weight bearing load of the authorized vehicle(s).
2. There shall be no vehicles or equipment operated in the open water of any specified river, lake, or stream under this GP.
3. The use of snow or ice bridges, access ramps, cribbing to cross any specified river or stream is prohibited unless specifically approved, in writing, by the ADF&G, Habitat and Restoration Division.
4. Access to or egress from frozen waters shall occur only at locations with gently or gradually sloping banks. There shall be no access to or egress from frozen waters at locations with sheer or cut banks.
5. The bed or banks of any specified river, lake, or stream shall not be altered or disturbed in any way to facilitate use of, access to, or egress from their frozen surfaces.
6. Vehicles or equipment shall not be left unattended while on the frozen surface of any specified river, lake, or stream.
7. No vehicles shall be fueled or serviced while on the frozen surface or below the ordinary high water line of any specified river, lake, or stream.

The permittee is responsible for the actions of contractors, agents, or other persons who perform work to accomplish the approved stream crossings. For any activity that significantly deviates from the approved plan, the permittee shall notify the ADF&G, Habitat and Restoration Division, and obtain written approval in the form of an individual permit before beginning the activity. Any action taken by the permittee or an agent of the permittee that increases the scope of the activity or that negates, alters, or minimizes the intent or effectiveness of any stipulation contained in this general permit will be deemed a significant deviation. The final determination as to the significance of any deviation and the need for an individual permit is the responsibility of the ADF&G, Habitat and Restoration Division. Therefore, it is recommended that the ADF&G, Habitat and Restoration Division, be consulted immediately when a deviation from the approved activity is being considered.

This letter constitutes a general permit issued under the authority of AS 16.05.870. Please be advised that this approval does not relieve you of the responsibility for securing other permits: state, federal, or local.

Pursuant to 6 AAC 80.010 (b), the conditions of this general permit are consistent with the Alaska Coastal Management Program.

In addition to the penalties provided by law, this general permit may be terminated or revoked for failure to comply with its provisions or failure to comply with applicable statutes and regulations. The department reserves the right to require mitigation measures to correct disruption to fish and game created by the authorized activity which were a direct result of the failure to comply with this general permit or any applicable law.

The recipient of this general permit (the permittee) shall indemnify, save harmless, and defend the department, its agents, and its employees from any and all claims, actions, or liabilities for injuries or damages sustained by any person or property arising directly or indirectly from permitted activities or the permittee's performance under this general permit. However, this provision has no effect if, and only if, the sole proximate cause of the injury is the department's negligence.

This general permit decision may be appealed in accordance with the provisions of AS 44.62.330--44.62.630.

Sincerely,

McKie Campbell, Deputy Commissioner

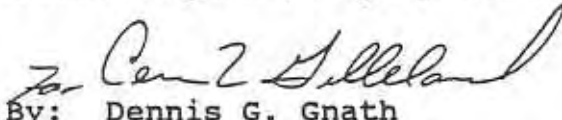

By: Dennis G. Gnath
Habitat Biologist
Habitat and Restoration Division
(907) 267-2284

cc: R. Thompson, DNR/DL
A. Samet, DNR/DL
D. Kelley, DNR/DL
S. Dunaway, DNR/DM
P. Pinard, DEC
P. Brna, SPCO
D. Webster, MSB
W. Wrede, City of Cordova
M. Pearsall, KPB
D. Dengel, City of Valdez

APPENDIX #2

SIGN FLOAT FOR LOON NESTS

(NOT LIKELY TO TURN OVER
IN THE STRONGEST WIND)

AERIAL VIEW

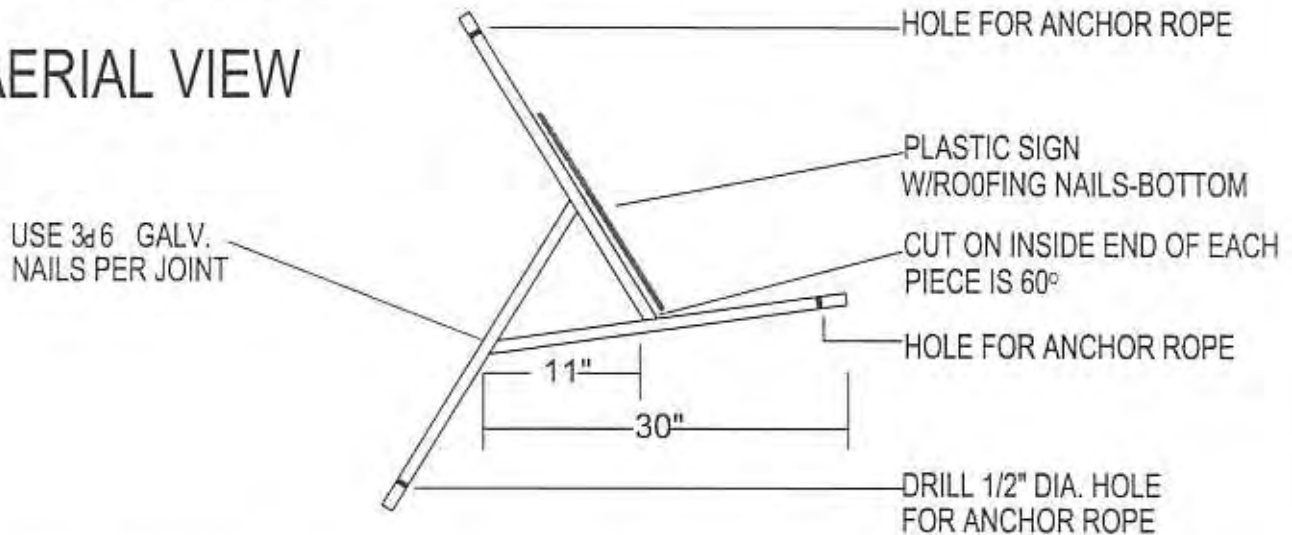

VIEW FROM WATER

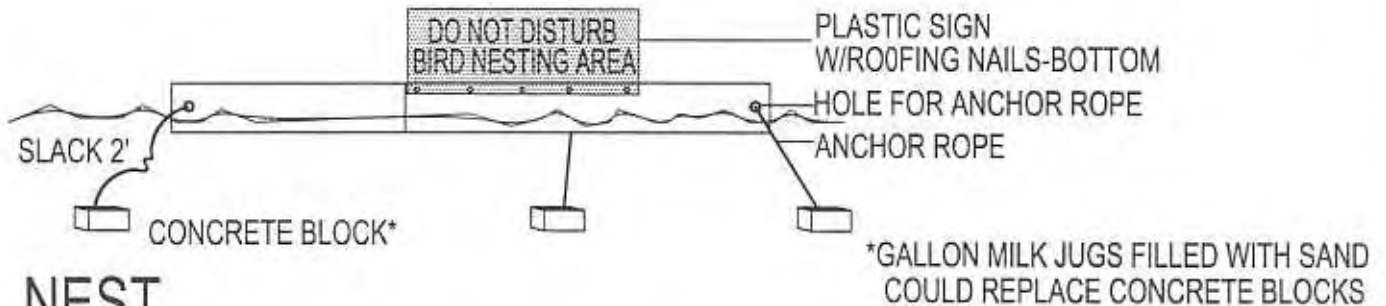

NEST

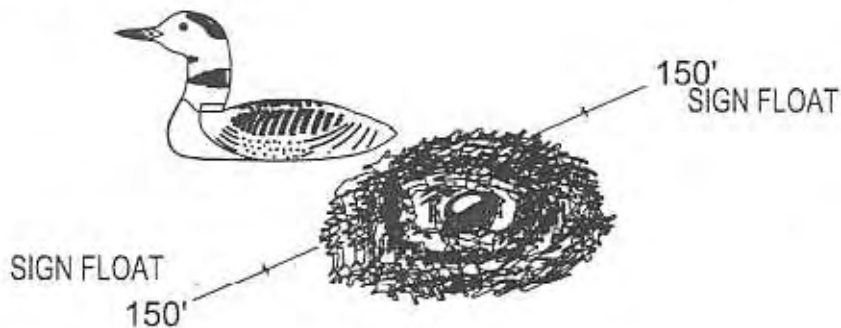

MATERIALS LIST

- 3 - 1"x 4"x 30" WHITE PINE OR NO. WHITE CEDAR
- 9 - 6d. GALV BOX NAILS
- 5 - 1" ROOFING GALV. NAILS
- 1 - LOON SIGN
- 2 - 3 CONCRETE BLOCK* FOR ANCHORS
- ENOUGH 1/4" NYLON ROPE TO REACH BOTTOM OF LAKE FOR ANCHOR

DESIGNED BY:
HERB CILLEY, PO BOX 348 TUPELO POINT, BOWLAKE, NORTHWOOD, N.H. 03261

ENHANCED BY:
MATANJUSKA-SUSTINA BORDOUJH SUPPORT SERVICE 1995

The platforms should be attached with two anchors a minimum of 150 feet from the nest (more, if needed to avoid disturbing the loons) and be clearly visible, yet not be a boating hazard. Signs should be removed after nesting is completed (usually by mid-July) each year to preserve their use. Signs should be stored over the winter in a dry area.

LOON ALERT



**Help keep this lake safe
for loons and other wildlife:**

1. Watch loons from a distance.
2. Pick up fishing line and other litter that may entangle loons.
3. Keep your dog on a leash.

Breeding loons have declined or disappeared from other U.S. states due to human disturbance and habitat loss. Wildlife harassment is illegal. Please report violations to Fish and Wildlife Protection (State Troopers) or call (800) 478-3377.

For loon information write: Alaska Department of Fish and Game, Division of Wildlife Conservation, 333 Raspberry Road, Anchorage, AK 99518.



STEER CLEAR!



**BOATERS – Stay at least 100 feet away
from nesting Red-necked Grebes.**

Grebes are duck-sized birds that nest on floating vegetation and debris in shallow water.

Wakes from watercraft will destroy their nests and kill their eggs and chicks.

Go slowly along shorelines and avoid nesting areas.

– HELP PROTECT ALASKA'S WILDLIFE –

Wildlife harassment is illegal. Report violations to Fish and Wildlife Protection (State Troopers) or call (800) 478-3377.

This sign was produced by a grant to the Alaska Watchable Wildlife Trust Fund, c/o Alaska Conservation Foundation, 430 W. 7th Avenue #215, Anchorage AK 99501 (907) 276-1917.

POSTED BY ALASKA DEPT. FISH AND GAME

