

FLOOD PLAIN MANAGEMENT STUDY

KASHWITNA RIVER, WASILLA,
COTTONWOOD, AND LUCILE CREEKS

ALASKA RIVERS COOPERATIVE STUDY

*Susitna River Basin, Talkeetna Subbasin
Matanuska-Susitna Borough, Alaska*



May, 1982

Prepared by the
U.S. Department of Agriculture
Soil Conservation Service
Economics Research Service
Forest Service

In cooperation with the
State of Alaska
Department of Natural Resources
Department of Fish and Game

FLOOD PLAIN MANAGEMENT STUDY

KASHWITNA RIVER, WASILLA, COTTONWOOD, AND LUCILE CREEKS

**MATANUSKA-SUSITNA BOROUGH
ALASKA**

*Prepared by the
U.S. Department of Agriculture
Soil Conservation Service
Economic Research Service
Forest Service*

Edward Grey, Hydraulic Eng. S.C.S.

*In cooperation with the
State of Alaska
Department of Natural Resources
Department of Fish and Game*

*Graphics by
Diane Martin DNR
Robin Hall, artist DNR*

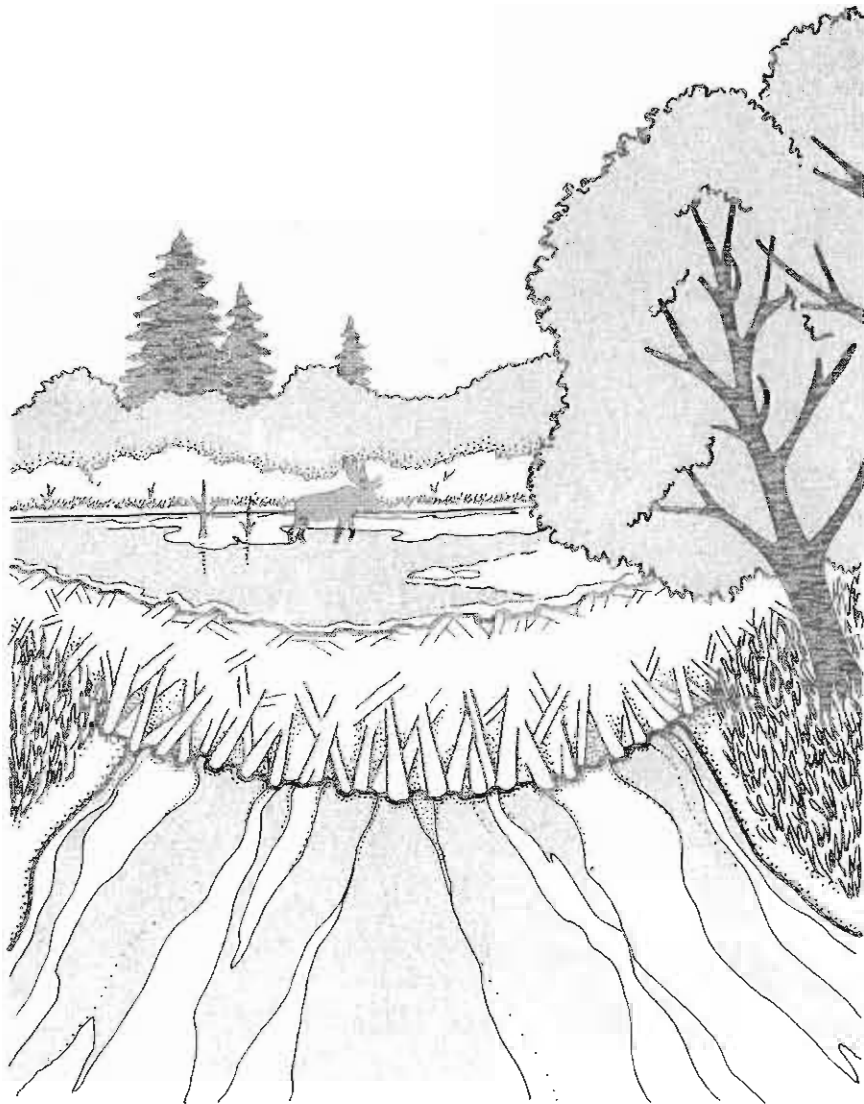

FOREWORD

The flood hazard information in this report will serve as a basis for local government and planning groups in formulating flood plain land use and management programs, adopting regulations, and providing the public with information concerning flood hazards along Kashwitna River, Wasilla Cottonwood, and Lucile Creeks.

The Soil Conservation Service implemented the technical phases of the study. The State of Alaska and Matanuska-Susitna Borough, Alaska Soil Conservation District and Palmer, Wasilla, and Montana Subdistricts assisted in providing land use data, obtaining permission for field surveys, and made available materials to be used for the study. They will distribute the report and make interpretations of the study data so it may be used effectively in local flood plain management programs. The State of Alaska, Matanuska-Susitna Borough and the SCS encourage the immediate use of the flood hazard information in implementing these programs and upon request will assist in the interpretation and use of the data presented in the report.

The cooperation and assistance given by other federal, state and local agencies and property owners in the collection of data for this report are greatly appreciated.

TABLE OF CONTENTS

FOREWORD	i	GLOSSARY	13
INTRODUCTION	1	BIBLIOGRAPHY	15
Local Study Needs and Authorities	1	TYPICAL VALLEY SECTIONS (Figure 2 - Figure 174)	17
DESCRIPTION OF STUDY AREA	1	APPENDIX A	193
VICINITY MAP	3	Table 1 - Present Frequency-Discharge-Elevation Data at Valley Sections	
FLOOD HISTORY	5	APPENDIX B	203
PRESENT FLOOD POTENTIAL	5	Table 2 - Elevation Reference Mark Description	
Flood Hazard Areas	5	APPENDIX C	221
Technical Data and Related Materials	8	Table 3 - 100-Year Flood Data - Present Conditions	
FUTURE FLOOD POTENTIAL	8	APPENDIX D	231
FLOOD PLAIN MANAGEMENT	9	Exhibit 1 - Flood Profile Index	
Management Programs	9	Exhibit 2 - Flood Profile Sheets	
Recommendations	10	APPENDIX E	271
INVESTIGATIONS AND ANALYSES	10	Exhibit 3 - Flood Plain Management Study Photomap Index	
Field Surveys	10	Exhibit 4 - Flood Plain Management Study Photomaps	
Hydraulics	10		
Hydrology	11		

INTRODUCTION

Local Study Needs and Authority

The Matanuska-Susitna Borough requested the Soil Conservation Service, through the Alaska Soil Conservation District and Alaska Department of Natural Resources, to carry out flood studies of several streams which presently have development along the stream banks. The local government feels that rapid development will take place in the near future, along the Parks Highway, Alaska Railroad, and other existing roads adjacent to these streams. Development will increase the potential flood damages to those properties in the flood plains. An immediate need exists to accurately define the existing flood hazard areas along existing travel routes. This report defines the areas subject to flooding so that adequate flood plain management programs can be implemented that regulate land use and development in flood prone areas. Such management programs will reduce potential flood damage, assure wise land use, and preserve and enhance the communities' physical environment.

This report will include Kashwitna River, Wasilla, Cottonwood, and Lucile Creeks. The details of work items involved in this analysis and authorities for USDA and State of Alaska agency participation are set forth in the Alaska Rivers Cooperative Study Plan of Work for the Willow and Talkeetna Subbasins dated February 1979. Three other flood hazard reports have been published under this Cooperative Study Plan of Work: "196 Mile, Caswell, Sheep, Goose, Montana, Answer, and Birch Creeks;" "Kroto, Rabideux, Trapper, and Peters Creeks;" and "Troublesome, Byers, and Honolulu Creeks, East and Middle Forks of Chulitna River."

The U.S. Corps of Engineers has published a Flood Plain Information Report on a portion of the Talkeetna River and a Flood Insurance Study of Willow Creek and the upper portion of the Little Susitna River and "Expanded Flood Plain Information Study, Willow, Alaska," 1980, which are within the Susitna River Basin.

DESCRIPTION OF THE STUDY AREA

The flood plain management report concerns Lucile, Cottonwood, and Wasilla Creeks and the Kashwitna River. They are bounded by the Kashwitna River-Caswell Creek and Talkeetna River drainage divide on the north, Matanuska River Basin boundary on the east and south, and the Susitna River on the west excluding 196 Mile, Little Willow, and Willow Creeks and Little Susitna River drainage areas. For details see "Location Map", Figure 1. The study area, for flood hazard concerns, encompasses about 451 square miles. The southern boundary of the area is about 50 miles by the road and 15 miles by air north of Anchorage. The Kashwitna River is about 85 highway miles north of Anchorage. The area is within the USGS hydrologic unit number 19050002. This number designates the Cook Inlet subregion of the Southcentral Alaska Region.



Source: SCS

The upper portion of Kashwitna River drainage area is in rough mountainous terrain.



Source: Forest Service Lab.

Typical lowland vegetation in wet areas is low growing brush with scattered black spruce.

Elevations range from mean sea level to about 6,700 feet above sea level. The area generally slopes to the west. The Kashwitna River drains into the Susitna River and heads in the Talkeetna Mountains which are steep and rough with some glaciers in the upper elevations. Wasilla and Cottonwood Creeks drain into the Cook Inlet at sea level elevations. Lucile Creek drains into Meadow Creek which flows into Big Lake, Fish Creek and into Cook Inlet. Wasilla, Cottonwood and Lucile Creeks head in low rolling hills.

Except for the mountainous area of the Kashwitna River drainage, the area is nearly level to undulating. Low hills with irregular slopes are prominent and poorly drained bogs and other wetlands are common.

Below timberline (about 2,000 feet above mean sea level elevation) on the better drained soils, paper birch-white spruce stands are the predominant vegetation. Black spruce is predominant on the poorly drained soils associated with numerous sphagnum bogs. Cottonwood, alder and willow are common in the flood plains adjacent to the streams. Vegetation above timberline, 2,000 feet to 6,700 feet elevation, is predominately of the tundra type.

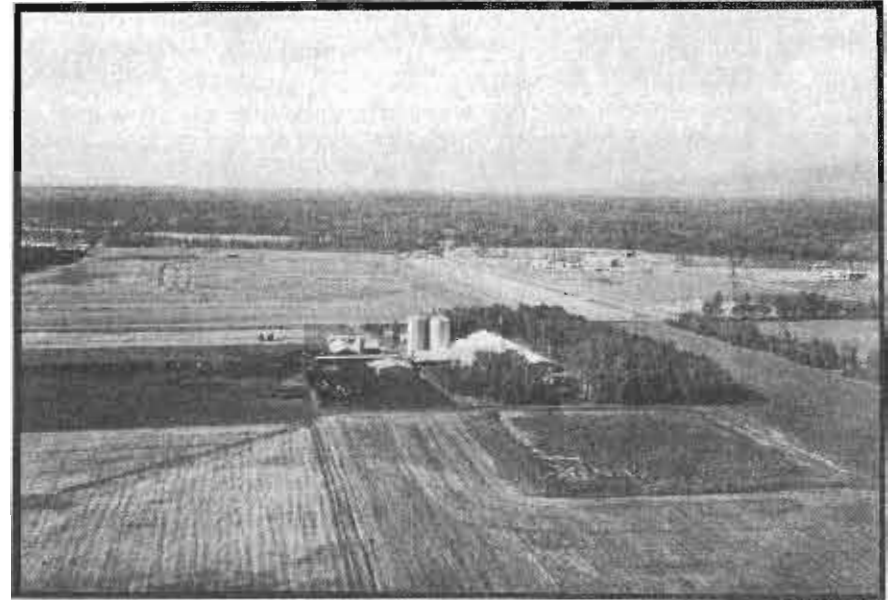

Source: SCS

Some timbered areas have been cleared and prepared for farming.

Stream channel slopes range from about 3 feet per mile in the lower reaches to about 100 feet per mile in the mountains. Highway 3 (Parks Highway) and the Alaska Railroad, running north and south, cross the streams in the study area.

The climate of the area is influenced by marine conditions in the south and continental conditions in the east. The temperature range is from a minus 45 degrees to 85 degrees F. The average daily maximum temperature in the summer is in the upper 60's with low 60's being common. Temperatures of 32 degrees F or lower have been recorded during every month of the year. Average maximum winter temperatures range from about zero to the midteens. The freeze-free period averages about 80 to 95 days. Average annual precipitation ranges from about 28 inches in the southwest to about 60 inches in the mountains. In the southwestern portion of the area, over half of the precipitation occurs from June 1 through the end of September.

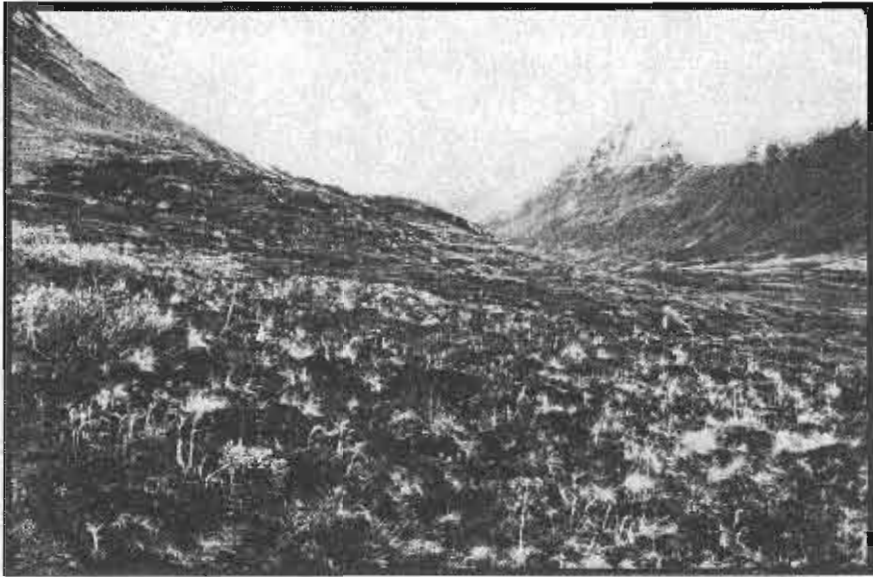

Source: SCS

Typical cover in the mountainous areas is tundra type vegetation.

FLOOD HISTORY

Development in the area has taken place in recent years, therefore, flood history has not been recorded.

Channel obstruction is a major factor which is significant in assessing flood damage. Ice jams have been witnessed on other streams in this vicinity. Montana and Willow Creek in December 1979 and Willow Creek in 1948 and October 1975 are examples of ice problems in streams in nearby areas. Glaciation could be a serious problem but sufficient data is not available for analyzing frequencies and locations of potential damage caused by obstructions.



Source: SCS

Development is sparse but there are some isolated homesteads.

FLOOD POTENTIAL (Present Conditions)

Flood Hazards

Present damageable property in the area consists of scattered homes and cabins, many of which are for seasonal use, small areas of farmland, and highway and railroad crossings. Damages to these properties from a 100-year event is estimated to be less than \$150,000 with average annual damage totaling less than \$8,000. A detailed damage analysis concerning the effect of flooding on stream fishing is beyond the scope of this study, however, under certain conditions, flooding could severely disrupt stream sports fisheries and have a long term negative impact on commercial

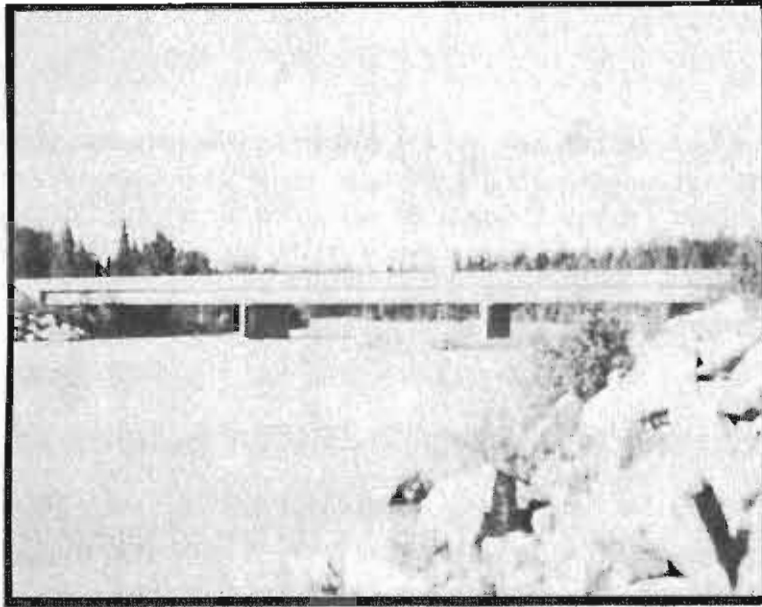

Source: SCS

Kashwitna River Bridge looking downstream at the Parks Highway Crossing.



Source: SCS

Wasilla Creek upstream from Fishhook Road crossing.

fisheries. See Appendix D, Exhibit 2, for water surface elevations and Appendix E, Exhibit 4, for area flooded by the 100-year event along the streams.

Area subject to inundation by the 100-year frequency storm event under present conditions are:

Stream Name	Acres
Kashwitna River	1,050
Wasilla Creek	.310
Cottonwood Creek	170
Lucile Creek	240
Total	1,770

Kashwitna River

Flood water from storms the size of the 100-year event and greater will overtop the highway embankment at the bridge approaches. The highway bridge approaches were designed and installed so the bridge structure would not be damaged from flood flows which exceed the bridge capacity. Stream velocities at the highway and railroad bridges are in excess of seven feet per second. Water flowing at these rates is capable of causing erosion to stream banks, flood plains, and the fill around highway and railroad structures. The rapidly rising and swiftly flowing flood water is a risk to human life and endangers private property.

Wasilla Creek

The flood flow caused by a storm with a return interval equal to or greater than the 50-year event will overtop the stream banks and damage farmland,

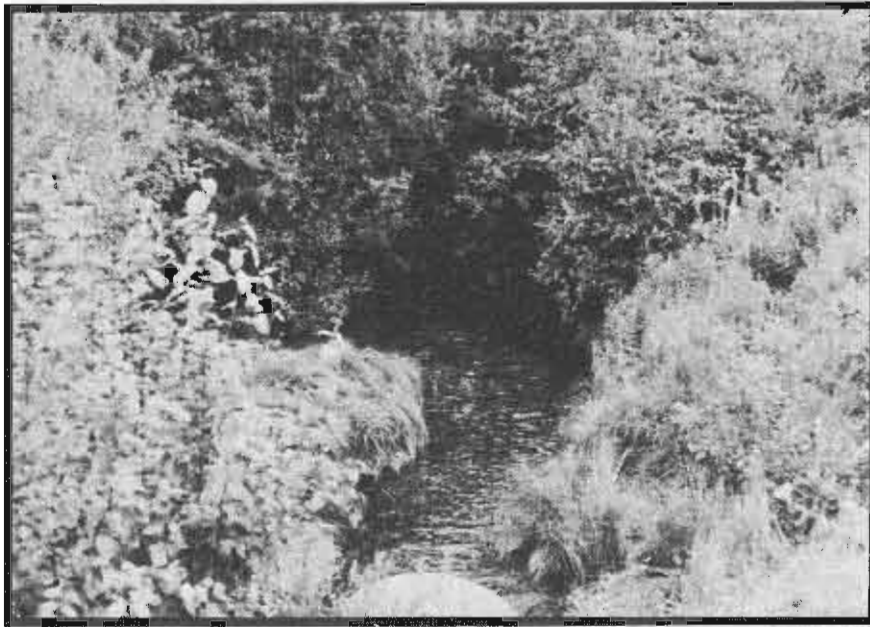

Source: SCS

Cottonwood Creek at Bogard Road crossing.

houses, barns and roads. Most culvert capacities, at road crossings, are exceeded by the 5-year event. The culverts, road fill, and road surface will be damaged and possibly need replacing on the average of once in twenty-five years.

Cottonwood Creek

Cottonwood Creek flows into Cottonwood and Wasilla Lakes upstream of the Parks Highway and Alaska Railroad crossings. Peak discharges that exceed the peak produced by a 5-year frequency event will overtop the crossing at Bogard Road, Palmer-Wasilla Road and Wasilla Loop Road. This would cause damage to the road fill and culverts and possibly the larger storms may endanger life and damage private property. The approaches to the culverts in the stream crossing are built to overflow before the flow capacities of the culverts are exceeded, therefore the culverts will not receive major damage. Flow velocities are in excess of seven feet per second which accelerates the rate of erosion around the highway and railroad



Source: SCS

Lucile Creek looking downstream at Big Lake Road crossing.

structures, stream banks and the flood plain. Development around Cottonwood and Wasilla Lakes, for the most part, is above the 100-year water surface elevation.

Lucile Creek

Lucile Creek flows into Lucile Lake and at the present time has no damageable property adjacent to the stream channel. However, there is a potential for development within the flood plain in the future. Development has taken place around Lucile Lake but most of it is above the 100-year event flood level.

Technical Data and Related Material

The technical data and related material needed for the intended uses of this study are provided as figures, exhibits and tables in this report.

Figures 2 through 174 are drawings of selected valley cross sections showing the flood elevations under present land use conditions for the 10-, 50-, 100-, and 500-year flood events.

Table 1 (Appendix A) is a tabulation of frequency-discharge-elevation data for present conditions at cross sections for the 10-, 50-, 100-, and 500-year floods. This table may provide greater convenience and efficiency when information is needed at specific locations. Table 2 (Appendix B) is a listing of descriptions and elevations for selected elevation reference marks established in the study area. Their locations are shown on the appropriate photomap indicated in the table. They may be used in establishing the relative locations of existing or planned buildings, roadways, and so forth, with the floodwater elevations. Table 3 (Appendix C) is a tabulation of stream channel stations, width of inundated area and average velocity at each cross section. Widths of area inundated are shown right and left looking downstream on the stream channel. Channel width is not included in the dimensions.

Exhibit 1 of Appendix D provides the index for Exhibit 2, flood profile sheets. Exhibit 2 provides plottings of the routed water surface elevations for the 10-, 50-, 100-, and 500-year peak discharges along the streams. The stations increase in an upstream direction from points indicated by the lower limits of the study. The profiles for the Kashwitna River were started at the estimated water surface in the Susitna River. The profiles for Wasilla and Cottonwood Creek were started at the outlet to the Cook Inlet above the high tide, 18.7 feet above mean sea level, published by the U.S. Weather Bureau. Lucile Creek profiles were run assuming normal flow at its confluence with Meadow Creek. A straight line interpolation was used between each cross section. These profiles may be used for those purposes which require flood elevations between cross sections or which require the location of flood boundaries on the ground.

To locate a flood profile elevation on the ground, determine on the appropriate flood plain management study photomap the distance along the stream from the point in question to the nearest cross section. On the appropriate profile sheet, use the distance from the reference cross section to determine the stream distance on the profile of the point in question and read the elevation of the desired flood frequency line. Transfer this elevation to the ground from the nearest reference mark. For the sake of safety one or two feet of free board should be added to the water surface elevations for first floor elevations of any development.

Exhibit 3 of Appendix E is a Flood Plain Management Study Photomap Index to determine the sheet number of the photomap desired.

The Flood Plain Management Photomaps, Exhibit 4 of Appendix E, show the area inundated by the 100-year flood. The actual limits of the 100-year flood line on the ground may vary somewhat from that shown because of interpolation between cross sections. These can be used to determine the location of points in question and their relationship to specific flood frequency as outlined above for Exhibit 2. They may also be used for flood plain management decisions or for purposes which require the approximate location of the 100-year flood plain.

The basic data used for determining the flood hazard information and peak discharge-frequency analysis in this report is on file in the office of the U.S. Department of Agriculture, Soil Conservation Service, 2221 E. Northern Lights Blvd., Suite 129, Anchorage, Alaska 99504.

FUTURE FLOOD POTENTIAL

The Matanuska-Susitna Borough is a participant in the HUD Flood Insurance Program administered by the Federal Insurance Administration. This participation guarantees that federally subsidized flood insurance coverage is available to owners and occupiers of all buildings and mobile homes (including contents) within the subbasin.

As required by the HUD Program the Borough has adopted land use management regulations which:

1. Insure that all new construction is designed to minimize flood loss, and
2. Require that all new construction or substantial improvements to existing structures have the first floor (including basement) level at or above the 100-year flood elevation and that all utilities be flood proofed.

With flood plain management regulations in effect it is expected that future residential, commercial, and industrial flood plain development will be such that flood damages to these properties will not increase above present levels. This presupposes that flood plains will be identified and used as a tool and a means for enforcing local ordinances and that the ordinances themselves are enforced. Should this fail to occur, damage potential will increase drastically with population growth.

Although the damage threat to existing development is expected to be arrested, it is doubtful that the same will be true of highways and railroads. Transportation networks are often found in and adjacent to floodplain lands as a result of construction costs. Even when flood damage costs are added to construction, operation, and maintenance costs, it often remains less expensive to build on flat lowland areas than on more rugged upland terrain.

FLOOD PLAIN MANAGEMENT

Management Programs

Regulatory measures presently adopted do not prevent flooding but, instead, reduce the threat of damage or loss of life from floods by discouraging development of homes and other buildings on floodplains. Without additional measures damage to existing property will continue and road and bridge related damages are likely to increase. As a means to minimize this situation the following alternatives are suggested.

1. For Existing Properties:

- a. Permanent measures built as an integral part of the structure, such as raising the elevation of the structure, water-proofing of basement and foundation walls, anchor and reinforce floors and walls, and use water-resistant materials.
- b. Contingency measures which require action to be taken to make them effective, such as manually closed flood gates and removable bulkheads.
- c. Emergency measures carried out during floods according to prior emergency plans, such as sandbagging, pumping, and removal of contents to flood-free areas.
- d. Reclamation of flood plains which includes the permanent evacuation of developed areas subject to inundation and the acquisition of these lands by purchase or land trades, the removal of structure, and the relocation of the population from such areas.
- e. Use of flood watch or warning systems to provide advance notice of impending flood danger.
- f. Buildings and mobile homes within or adjacent to the delineated flood hazard areas in Appendix A of this report should carry flood insurance on the structure and its contents. Although this will not reduce existing damage potential, it will have the positive effect of spreading the flood hazard risk.

2. For Future Road and Bridge Construction

- a. When analyzing proposed alternative transportation routes, the costs of potential flood damage will continue to be investigated and included for use in the decision making process.
- b. Construction designs will continue to reflect sound engineering judgement with regards to flood hazard potential. This includes the analysis of soils, geology, hydrology and hydraulics, as well as adequacy of construction materials.

Recommendations

It is not the intent of this report to provide solutions to flood problems in the study area; however, it does furnish an information base for the adoption of an overall **flood plain management program**. Other management programs dealing with **environmental values of flood plains** may also benefit from this information. **Following are recommendations** which should be emphasized during **development and implementation** of this program.

1. Adopt and/or enforce flood plain regulations in compliance with the National Flood Insurance Program as a minimum. The regulations should address such things as minimum floor elevations, floodways, greenbelt areas, adequate drainage facilities, building and housing codes, and sanitary codes with specific flood hazard provisions for all new construction.
2. Consider nonstructural measures for flood prevention such as flood plain acquisition, flood proofing, and flood forecasting and warning systems. Federal cost sharing for these measures may be available under Section 73(b) of Public Law 93-251. The realization of the need for a flood warning system is due to the projected rapid development of the flood plains that have occurred in the past decade and the high velocities in the streams. The National Weather Service of the National Oceanic and Atmospheric Administration issues frequent warnings of potential flood producing storms. Frequently the flood warnings are preceded by a "severe weather or flood watch."
3. Include in land development ordinance the provision for on-site runoff and sediment storage. A continuous maintenance program needs to be provided for these types of measures.
4. Owners of property subject to flood damage (including areas adjacent to the delineated flood hazard areas) should be encouraged to purchase flood insurance on their buildings, mobile homes, and their contents.
5. Develop a regular maintenance program to keep all hydraulic structure openings, approach channels, and outfall channels clear of sediment and debris.

INVESTIGATIONS AND ANALYSES

The hydraulic and hydrologic investigations followed procedures in the SCS publications National Engineering Handbook, Section 4, Hydrology (NEH-4) and Section 5, Hydraulics (NEH-5), and other technical references. Computer programs developed by the SCS were used for most of the analyses.

Field Surveys

Field surveys were completed in 1980. Vertical control for most of the surveys were referenced to the National Geodetic Vertical Control Datum of 1965-1968.

The upper portion of Cottonwood Creek, from cross section C-BT through C-BZRD, and the lower portion of Lucile Creek, from cross section L-A through L-AC, are done at the approximate level.

Elevations in the approximate reaches were estimated from USGS topographic quadrangles. The 1:25,000 scale with 5 meter contour interval was used for that reach of the Cottonwood Creek and 1:63,360 with 50 feet contour interval for that reach of Lucile Creek.

A few key cross sections were field surveyed and other cross sections were made by use of the key cross sections, and detailed surveys with 5.0 foot contour interval. Field surveys were done under contract by a private engineering firm. All mapping done within the limits of National Mapping standards.

Hydraulics

Elevation-discharge relationships were developed for all bridges, culverts, and valley sections utilizing the water surface profile computer program

WSP2 outlined in SCS Technical Release No. 61. The hydraulic parameters of the channel and flood plain for the conditions existing prior to 1979 were input data for the WSP2 program. High water marks, stream gage records, and other historical flood data were used in checking the accuracy of the computed water surface profiles. There is one stream gage located on Cottonwood Creek with a short period of record, 1949-1954. This record was utilized to help determine the accuracy of the computed hydraulics.

Hydrology

Peak frequency (annual series) studies were made by the USGS for all Alaska. The USGS published a regional analysis, "Flood Characteristics of Alaskan Streams," Water Resources Investigations 78-129, dated 1979, which presents regional equations for two areas in Alaska, Area I and Area II.

The study area is located in Area II. Peak-frequency curves were developed using the equation proposed by USGS and by use of the Log-Pearson Type III method. Peaks calculated by these two methods for given storm frequencies were compared to one another to determine the adequacy of the regional equation for this study. From these comparisons it was determined that the regional equation was adequate for the relatively flat and lowland areas of Wasilla, Cottonwood and Lucile Creeks. However, for Kashwitna River the regional equation was determined inadequate and the following method was used to develop peak-frequency curves.

Twenty-six stream gages within the Southcentral Region were used to develop peak-frequency curves in an effort to obtain more reliable peaks for the study area.

Thirteen of these gage records were discarded because watershed characteristics and/or drainage areas were not representative of the study area and/or the time of stream gaging was too short for adequate frequency analysis. Eleven of the gage records, on streams within the Cook Inlet drainage, were used to make a final determination of peak-frequency curves to be used in this study area.

An envelope for high, medium, and low peak discharge curves, for the 2-year, 10-year, 50-year, 100-year and 500-year events was developed. (See Appendix E, Exhibit 5, 6, 7, 8, and 9 of the "Flood Hazard Study for 196 Mile, Caswell, Sheep, Goose, Montana, Answer, and Birch Creeks" by SCS, 1981.) These curves and watershed characteristics such as watershed slope, channel length and slope, mean elevation, land cover and average annual precipitation, were used to develop a peak-frequency curve for each watershed at each cross section.

Cottonwood and Lucile Creeks both run through lakes for a long distance in route to their outlets. At these locations the outlets of the lakes were found to be the controlling factor in the water surface routings. Peak discharges were determined at the lake outlets and from that point downstream the watershed areas above the outlets were considered non-contributing.

The peak discharge for each area above each cross section for the 10-, 50-, 100-, and 500-year storm events was taken from these curves and used for channel flood routing on each stream to determine water surface elevations and the area inundated.

GLOSSARY

ANNUAL SERIES - A frequency series in which only the largest value in each year is used, such as the annual floods.

BACKWATER - The resulting high water due to a downstream obstruction or restriction or from high water elevations in an intersecting stream.

BM - Bench mark. See elevation reference mark.

CFS - Abbreviation for cubic feet per second. The rate of discharge or flow of water representing a volume of 1 cubic foot passing a given point during 1 second.

CHANNEL - A natural or artificially created open conduit that periodically or continuously conveys water. River, creek, stream, branch, and tributary are some of the terms used to describe channels.

CROSS SECTION (stream or valley) - The shape of a channel, stream, or valley viewed across the axis. In watershed investigations it is determined by a line approximately perpendicular to the main path of water flow, along which measurements of distance and elevation are taken to define the cross sectional area.

CSM - Abbreviation for cubic feet per second per square mile. (Rate of discharge per square mile of drainage area.)

DRAINAGE AREA - The area, measured in a horizontal plane, which drains into a stream at a specified location. See watershed.

ELEVATION REFERENCE MARK - A fixed reference, usually placed on or near the ground, giving the measurement in elevation of that point in relation to mean sea level. Bench mark (BM) or (TBM) temporary bench mark is the common term used by surveyors.

FLOOD - An overflow or inundation of normal dry lands from a stream or other body of water; the high streamflow overtopping the banks of a stream; or a high flow as measured by either stage or discharge.

FLOOD PLAIN MANAGEMENT AREA PHOTOMAP - A photographic background map that indicates areas likely to be flooded by the 100

year frequency or the one percent chance flood (it has one chance in 100 of being equaled or exceeded in any given year (from an adjoining stream or water body).

FLOOD CREST - The maximum stage or elevation reached by the waters of a flood at a given location.

FLOOD FREQUENCY - The average interval of time between floods equal to or greater than a specified discharge or stage. It is generally expressed in years. Following are examples:

10-year flood or 10-year frequency flood. The flood which can be expected or exceeded on an average once in 10 years; and which would have a 10 percent chance of being equaled or exceeded in any given year.

50-year flood ... two percent chance ... in any given year.

100-year flood ... one percent chance ... in any given year.

500-year flood ... two-tenths percent chance ... in any given year.

FLOOD HAZARD - A general term meaning the risk to life or damage to property from overflows of rivers or stream channels, extraordinary waves or tides occurring on lake or estuary shores; floodflows in intermittent or normally dry streams; floods on tributary streams; floods caused by accumulated debris or ice in rivers; or other similar events.

FLOOD PEAK OR PEAK DISCHARGE - The highest value of the stage or discharge attained by a flood, thus, peak stage or peak discharge.

FLOOD PLAIN OR FLOOD-PRONE AREA - The land area situated on either side of a channel or body of water which is subject to flooding.

FLOOD PLAIN MANAGEMENT - The operation of an overall program of corrective and preventive measures for reducing flood damage, including but not limited to emergency preparedness plans, flood control works, and land use and control measures.

FLOOD PROFILES - A plot or graph defining the water surface elevation in relation to the distance along the stream during a particular flood.

FLOOD ROUTING - Determining the changes in a flood wave as it moves downstream through a valley or through a reservoir (then sometimes called reservoir routing). Graphic or numerical methods are used.

FREQUENCY-DISCHARGE-ELEVATION - The relationship of the flood frequency of discharges and the water elevations resulting from these discharges at a surveyed cross section or other point along a stream. This data may be shown as a plotted curve or in table form.

GREENBELT AREA - A strip of land kept in its natural or relatively undeveloped state or in agricultural use which is planned around the periphery of urban development or in the flood plain of a stream or body of water.

HEADWATER - (1) The source of a stream. (2) The water upstream from a structure or point on a stream.

LEFT FLOOD PLAIN - The flood plain on the left side of a river, stream, or watercourse, looking downstream.

MANNING'S "n" VALUE - A coefficient of roughness in Manning's flow equation for determining stream velocities.

RIGHT FLOOD PLAIN - The flood plain on the right side of a river, stream, or watercourse, looking downstream.

RUNOFF - That portion of the precipitation on a drainage area that is discharged from the area in stream channels. Types include surface runoff, groundwater runoff, or seepage.

SEDIMENT - Solid material, both mineral and organic, that is in suspension, and is being transported, or has been moved from its site of origin by air, water, gravity, or ice, and has come to rest on the earth's surface.

STREAM - Any natural channel or depression through which water flows either continuously, intermittently, or periodically, including modification of natural channel or depression.

STRUCTURE - Anything constructed or erected, the use of which requires a more or less permanent location on or in the ground. Includes but is

not limited to bridges, buildings, canals, dams, ditches, diversions, irrigation systems, pumps, pipelines, railroads, roads, sewage disposal systems, underground conduits, water supply systems, and wells.

SUPERCritical FLOW - Those conditions of flow for which the depth is less than critical and the velocity is greater than critical. Critical flow is the term used to describe open channel flow when the discharge is maximum for a given specific energy head, or stated conversely, those which exist when the specific energy head is minimum for a given discharge.

TBM - Temporary bench mark. See elevation reference mark.

WATERSHED - The area contributing direct runoff to a stream. Usually it is assumed that base flow in the stream also comes from the same area. However, the groundwater watershed may be larger or smaller.

CONVERSION TABLE

Multiply inch-pound units	by	to obtain SI units
cubic feet per second (ft ³ /s)	0.0283	cubic meters per second (m ³ /s)
cubic feet per second per square mile [(ft ³ /s)/mi ²]	0.0109	cubic meters per second per square kilometer [(m ³ /s)/km ²]
square miles (mi ²)	2.589	square kilometers (km ²)
feet (ft)	0.3048	meters (m)
inches (in.)	2.540	centimeters (cm)
degrees Fahrenheit (°F)	5/9(°F-32)	degrees Celsius (°C)

BIBLIOGRAPHY

1. U.S. Department of Agriculture, Soil Conservation Service: SCS National Engineering Handbook, Section 4, Hydrology, August 1972.
2. U.S. Department of Agriculture, Soil Conservation Service: SCS National Engineering Handbook, Section 5, Hydraulics, Supplement B, August 1956.
3. U.S. Department of Agriculture, Soil Conservation Service: WSP2 Computer Program, Technical Release No. 61, May 1976.
4. U.S. Department of Agriculture, Soil Conservation Service: A Method for Estimating Volume and Rate of Runoff in Small Watersheds, Technical Paper 149, April 1973.
5. U.S. Department of Agriculture, Soil Conservation Service: Urban Hydrology for Small Watersheds, Technical Release No. 55, January 1975.
6. U.S. Department of the Army, Office of the Chief Engineers: A Perspective on Flood Plain Regulations for Flood Plain Management. June 1, 1976.
7. U.S. Department of Commerce, National Oceanic and Atmospheric Administration, National Ocean Survey, National Geodetic Survey, Sealevel Datum of 1929, Vertical Control Data, 1965 tentative adjustment, Line 101, First Order Leveling, September 1966.
8. U.S. Department of Commerce, Weather Bureau: Rainfall Frequency Atlas of the United States, Technical Paper No. 47, May 1963.
9. U.S. Department of the Interior, Geological Survey, 15 Minute Series (Topographic) Maps, Scale 1:63,360, 50 feet and 100 feet contour interval.
10. U.S. Department of Interior, Geologic Survey, Flood Characteristics of Alaskan Streams, 1979.
11. U.S. Department of Interior, Geological Survey, Annual Peak Flow Data Retrieval Computer Program.
12. U.S. Department of Interior, Geological Survey, Water Data Reports, Water Resources Data for Alaska, 1948-1977.
13. U.S. Department of Interior, Geological Survey, Annual Peak Flow Frequency Analysis, Computer Program Following WRC Guidelines. Rev. 07/20/79.
14. U.S. Water Resources Council: A Unified National Program for Flood Plain Management, July 1979.
15. U.S. Water Resources Council: Guidelines for Determining Flood Flow Frequency, Bulletin No. 17A, Rev. June 1977.

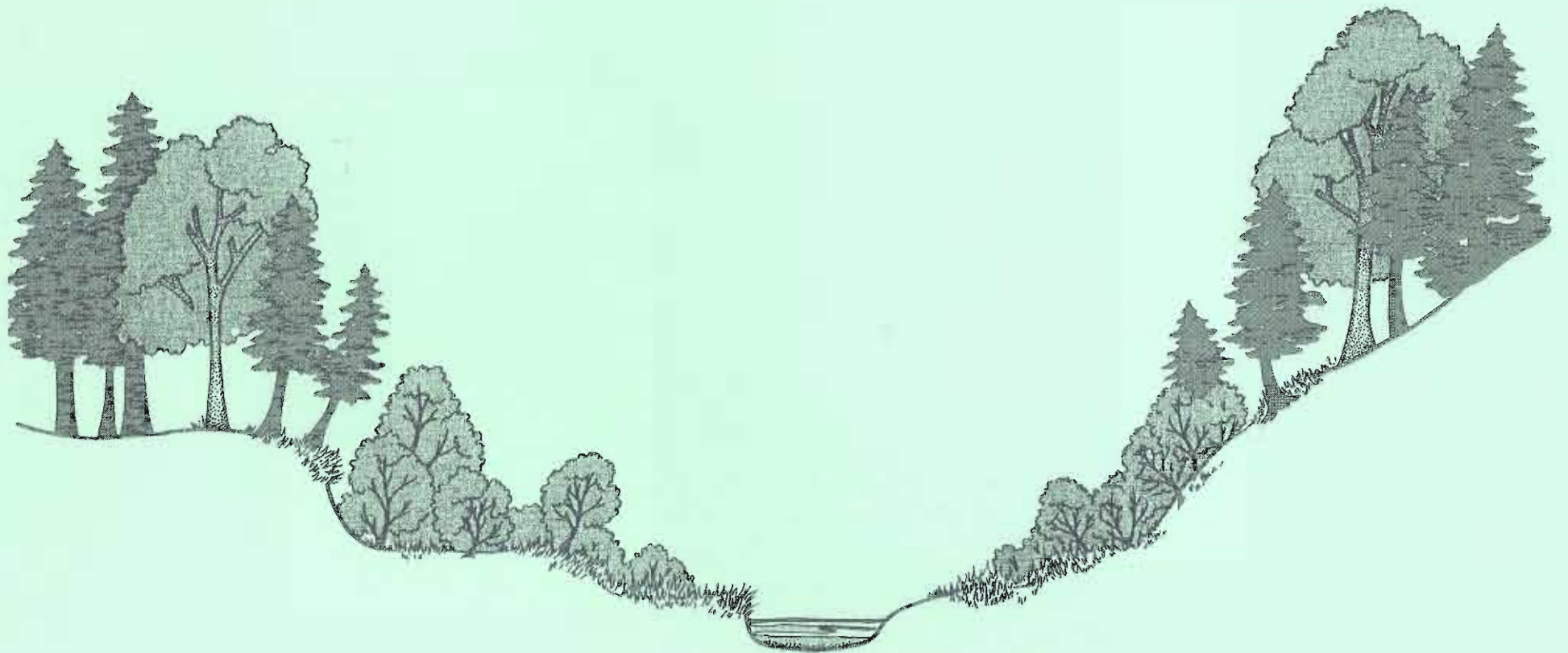

Typical Valley Sections

Figures 2 through 174

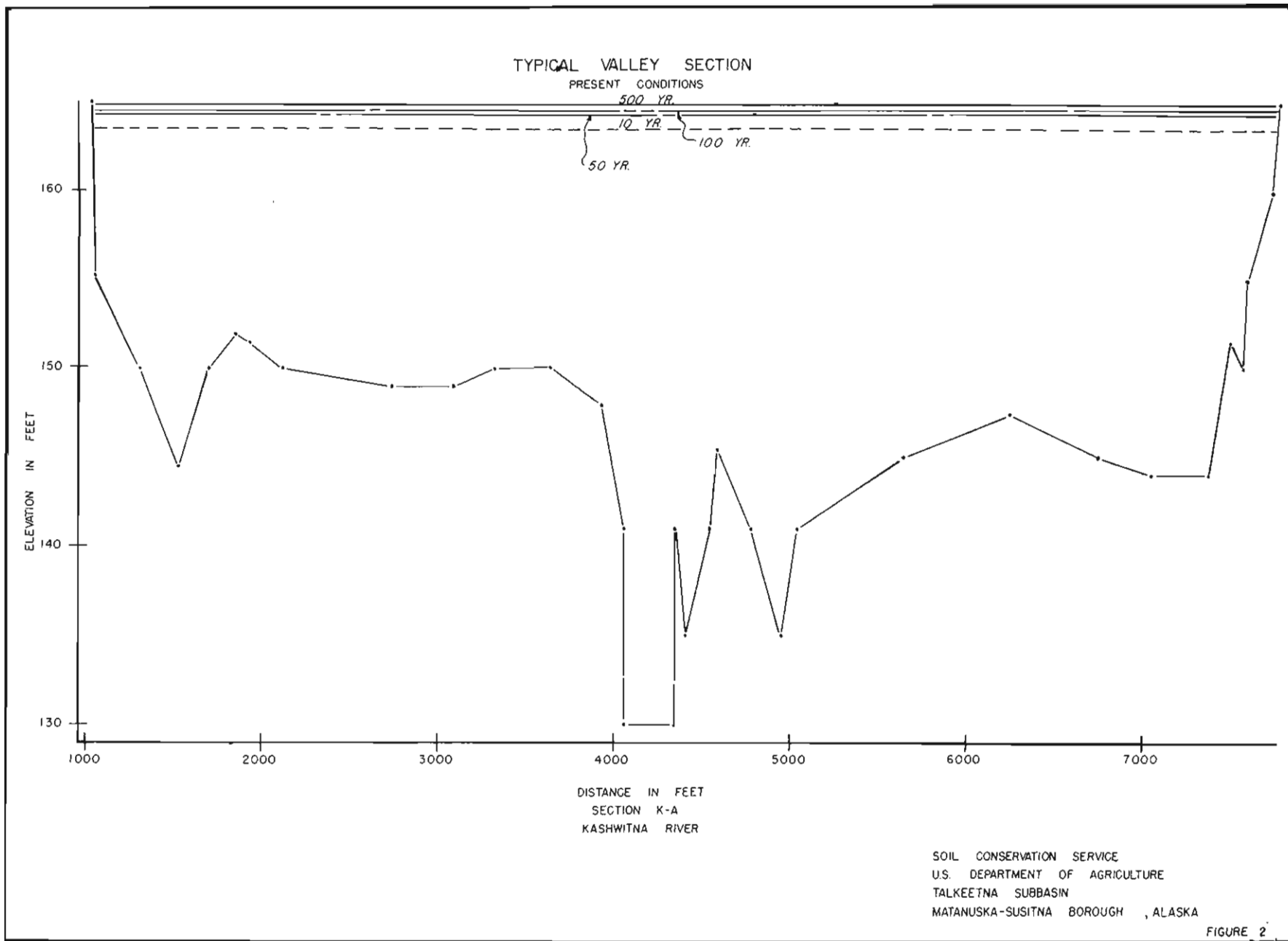

TYPICAL VALLEY SECTION
PRESENT CONDITION

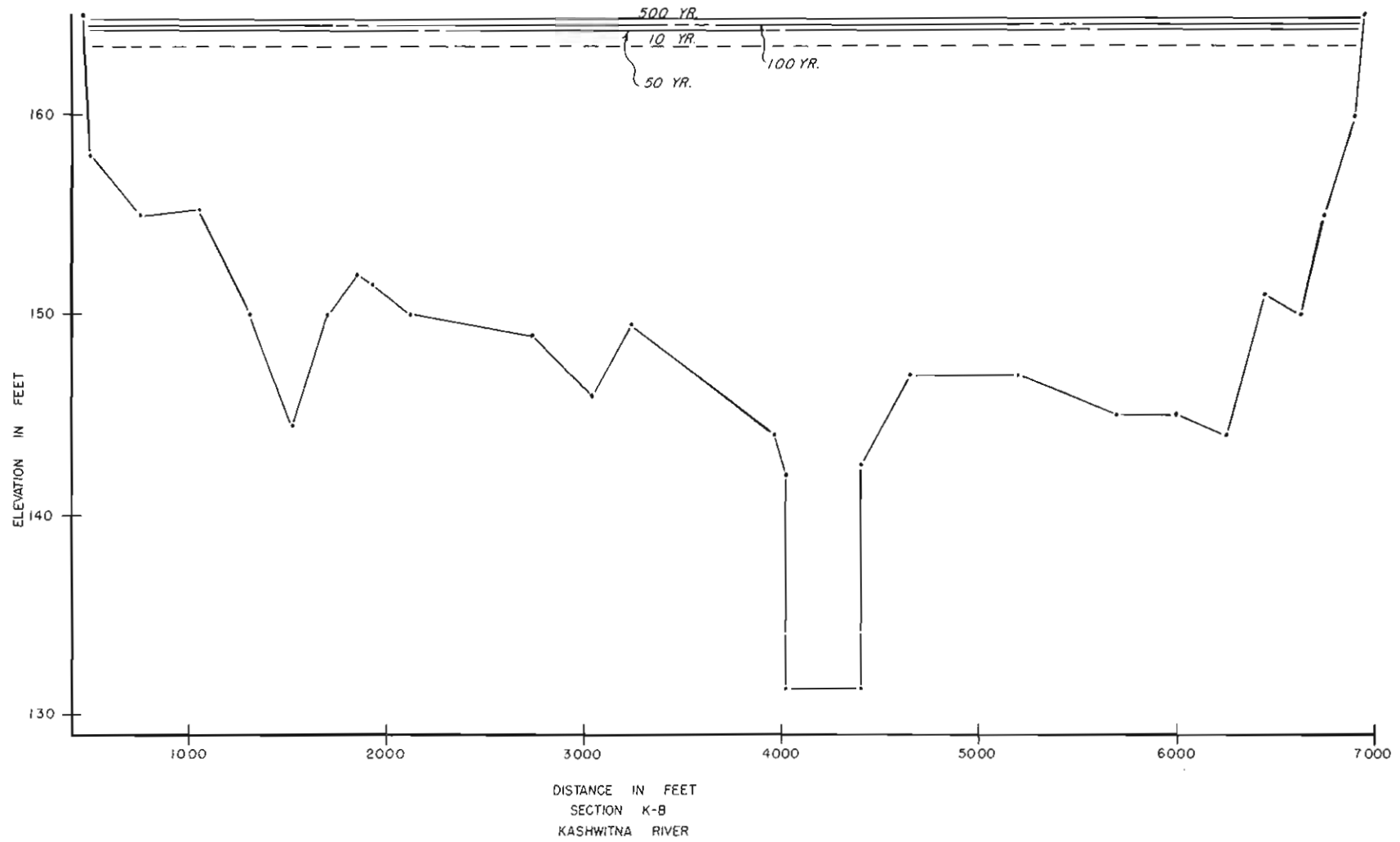

SOIL CONSERVATION SERVICE
U. S. DEPARTMENT OF AGRICULTURE
TALKEETNA SUBBASIN
MATANUSKA-SUSITNA BOROUGH, ALASKA

FIGURE 3

TYPICAL VALLEY SECTION
PRESENT CONDITIONS

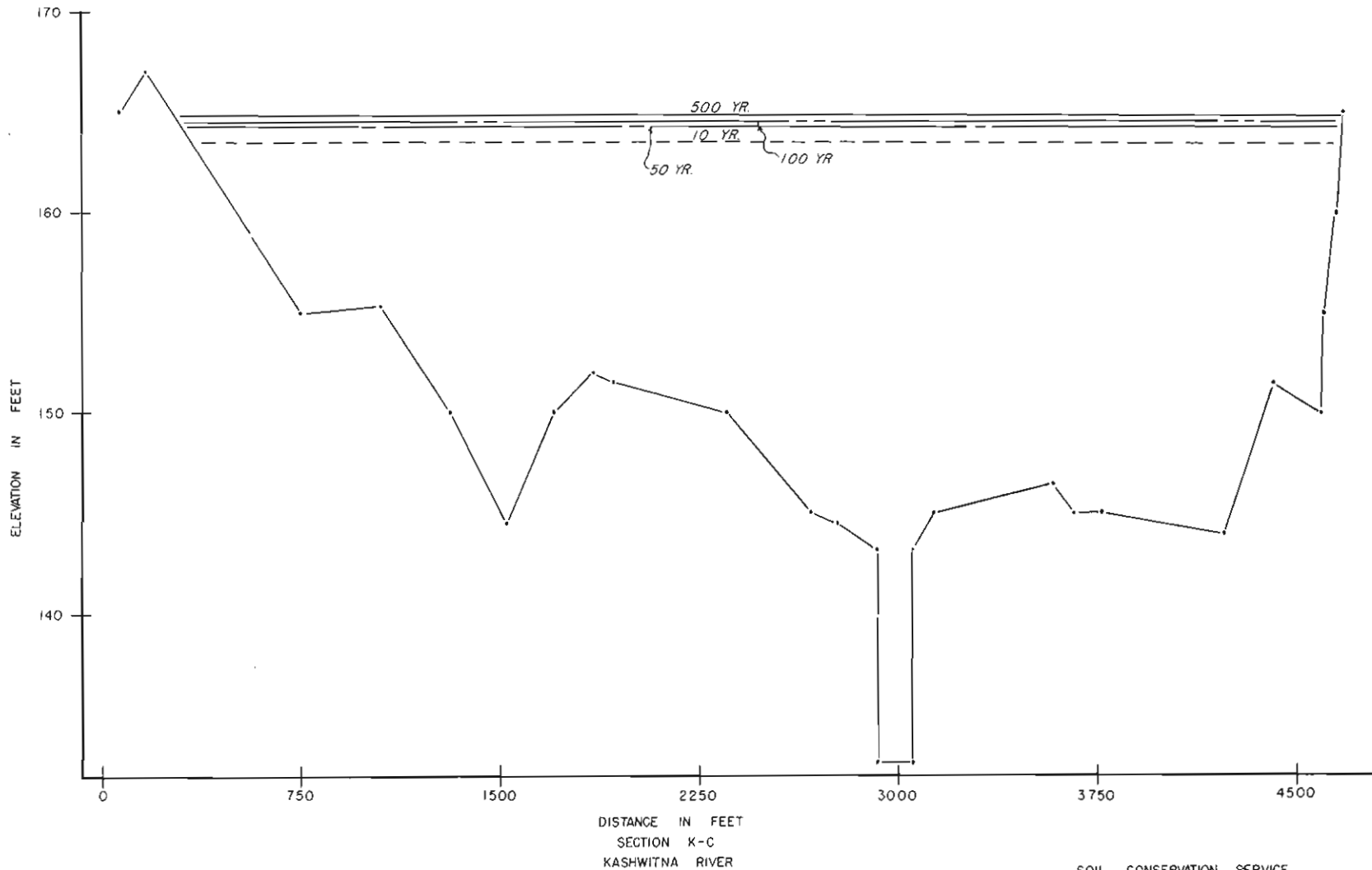

SOIL CONSERVATION SERVICE
U.S. DEPARTMENT OF AGRICULTURE
TALKEETNA SUBBASIN
MATANUSKA-SUSITNA BOROUGH, ALASKA

FIGURE 4

TYPICAL VALLEY SECTION
PRESENT CONDITIONS

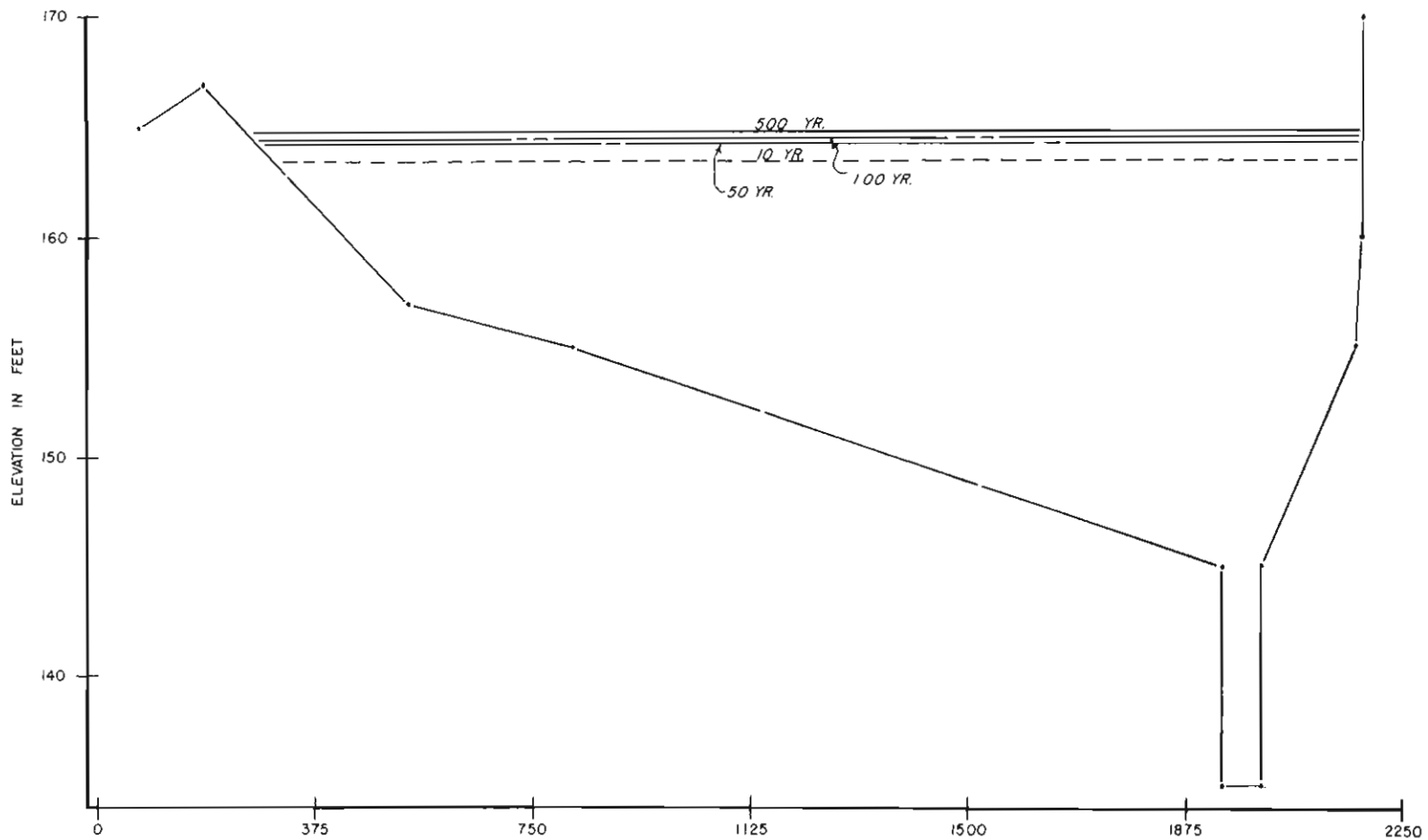

DISTANCE IN FEET
SECTION K-D
KASHWITNA RIVER

SOIL CONSERVATION SERVICE
U.S. DEPARTMENT OF AGRICULTURE
TALKEETNA SUBBASIN
MATANUSKA-SUSITNA BOROUGH, ALASKA

TYPICAL VALLEY SECTION
PRESENT CONDITIONS

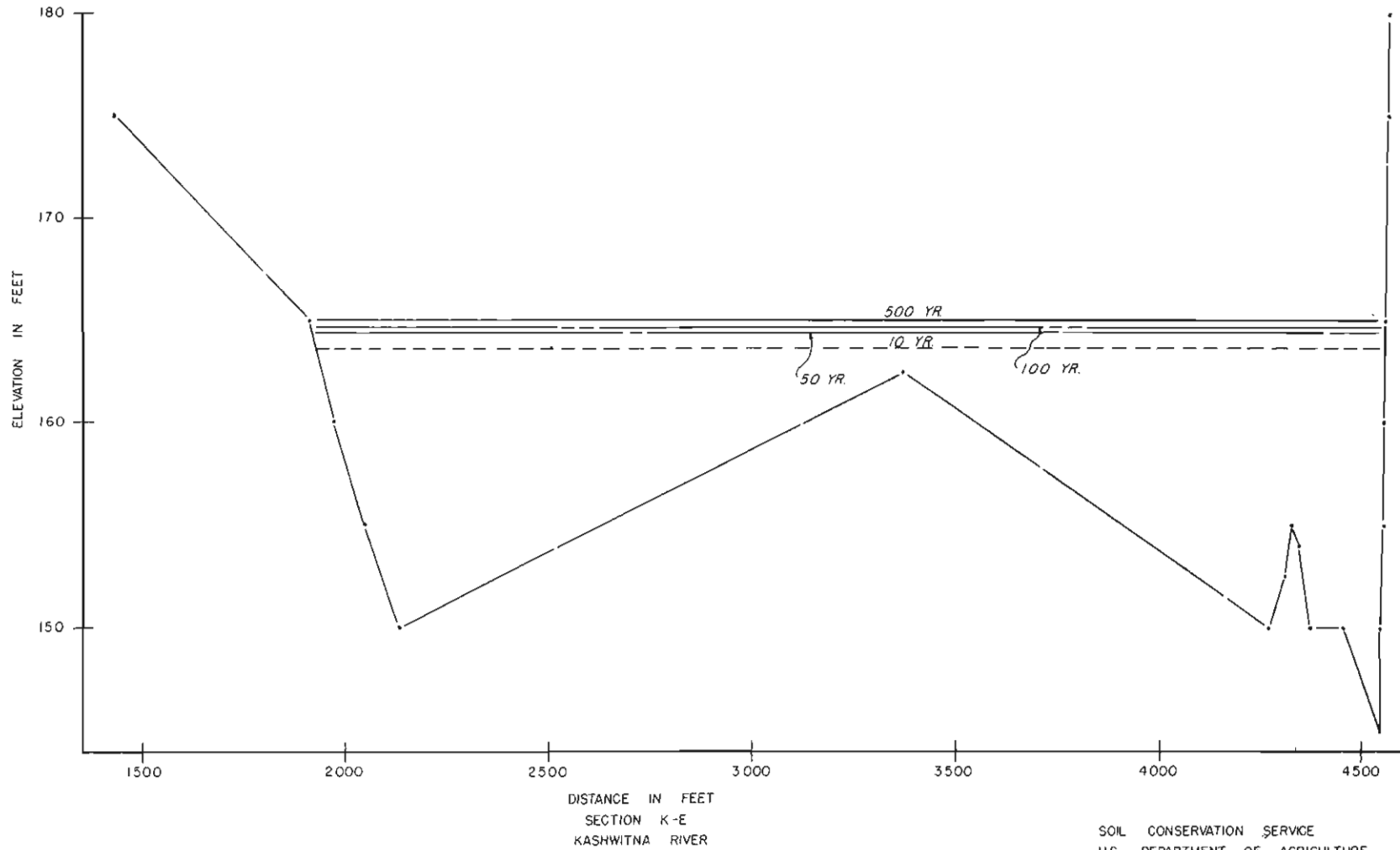

SOIL CONSERVATION SERVICE
U.S. DEPARTMENT OF AGRICULTURE
TALKEETNA SUBBASIN
MATANUSKA - SUSITNA BOROUGH, ALASKA

TYPICAL VALLEY SECTION
PRESENT CONDITIONS

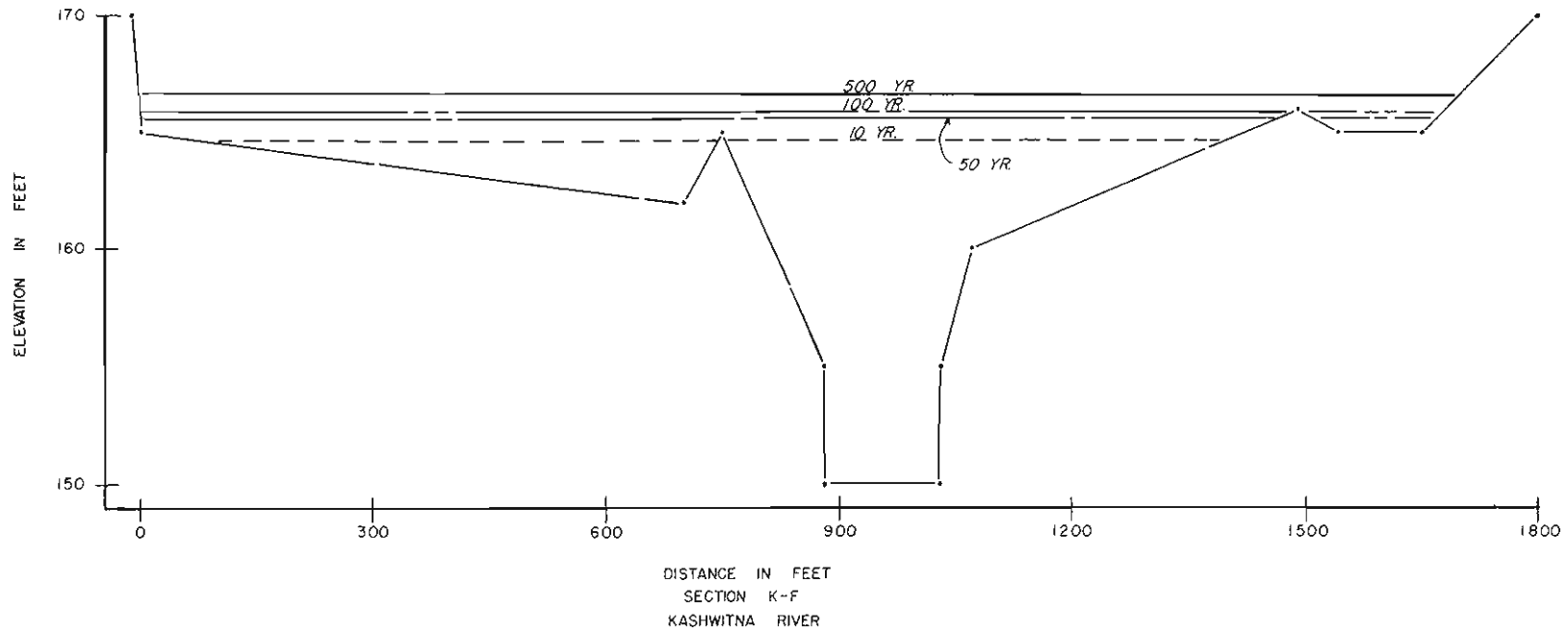

SOIL CONSERVATION SERVICE
U.S. DEPARTMENT OF AGRICULTURE
TALKEETNA SUBBASIN
MATANUSKA - SUSITNA BOROUGH, ALASKA

FIGURE 7

TYPICAL VALLEY SECTION
PRESENT CONDITIONS

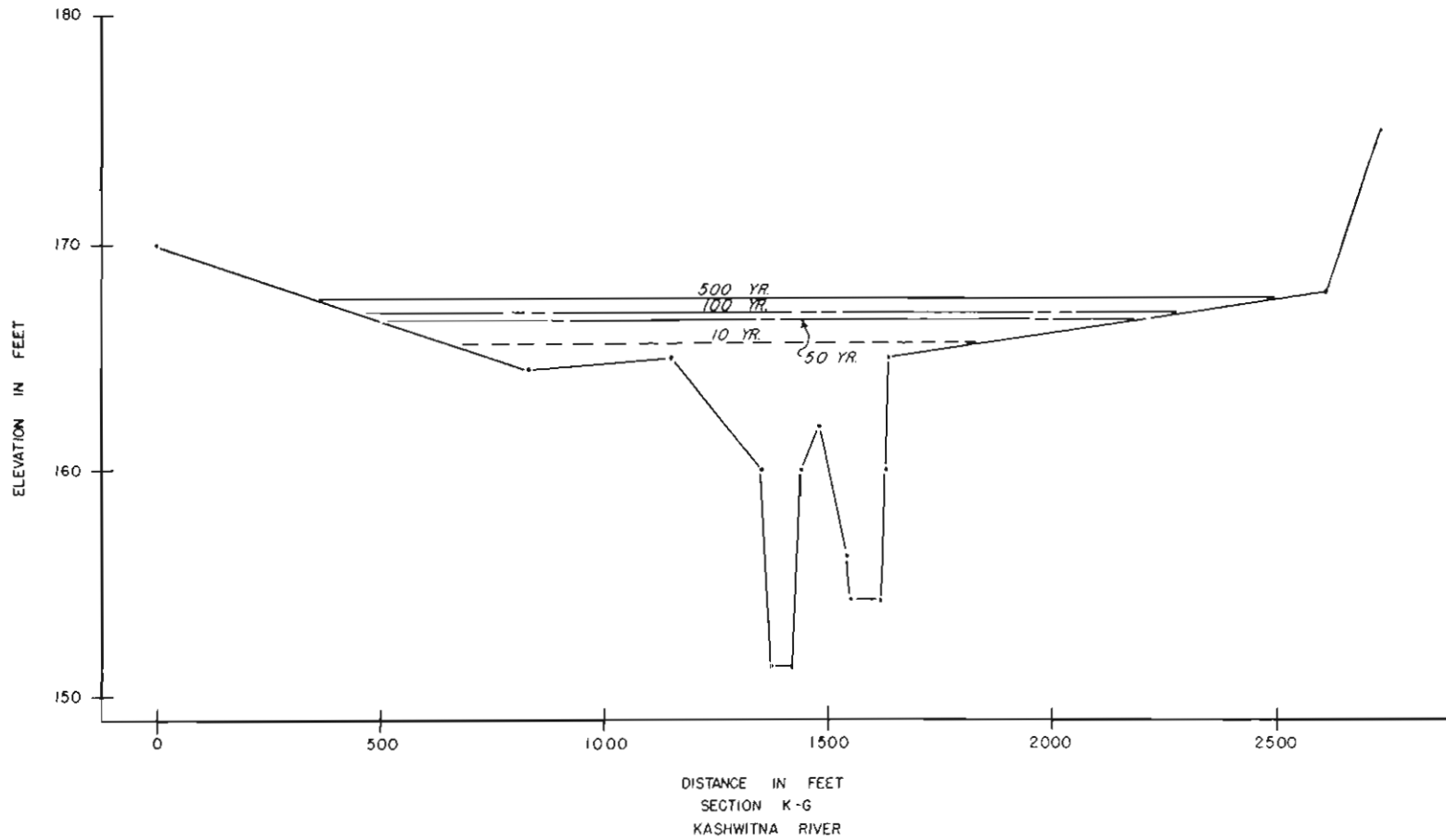

SOIL CONSERVATION SERVICE
U.S. DEPARTMENT OF AGRICULTURE
TALKEETNA SUBBASIN
MATANUSKA - SUSITNA BOROUGH, ALASKA
FIGURE 8

TYPICAL VALLEY SECTION
PRESENT CONDITIONS

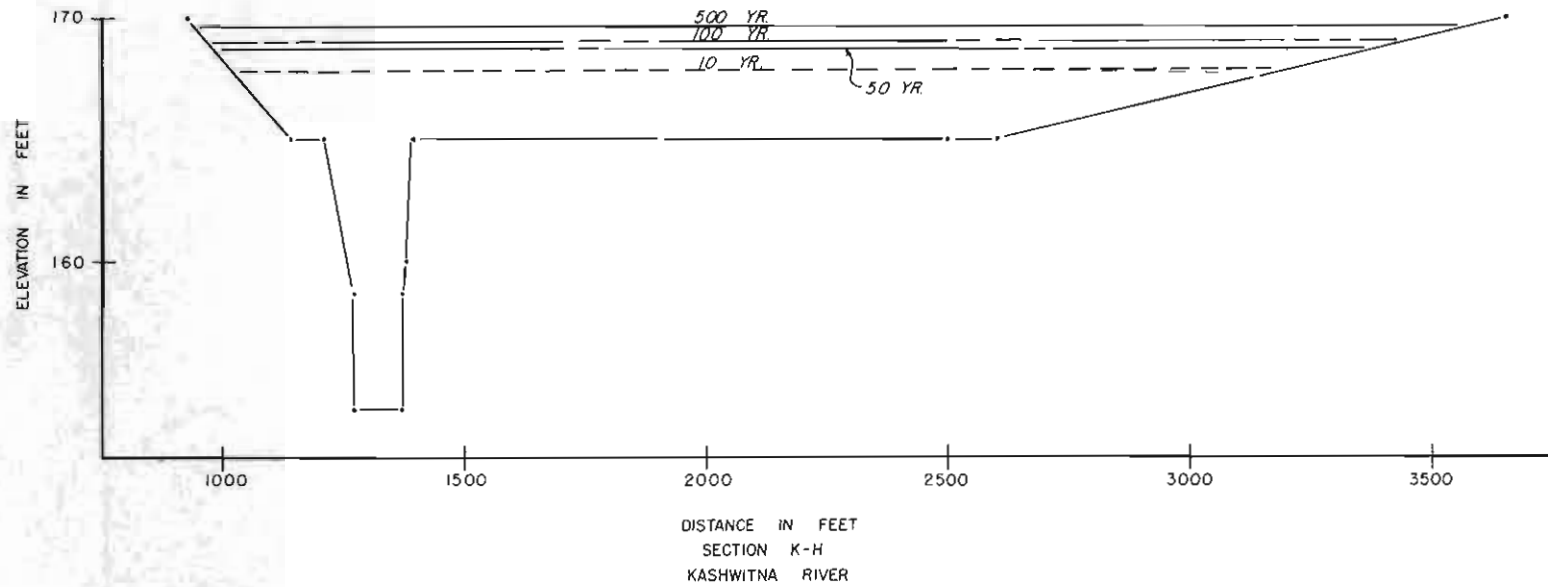

SOIL CONSERVATION SERVICE
U.S. DEPARTMENT OF AGRICULTURE
TALKEETNA SUBBASIN
MATANUSKA - SUSITNA BOROUGH, ALASKA
FIGURE 9

TYPICAL VALLEY SECTION
PRESENT CONDITIONS

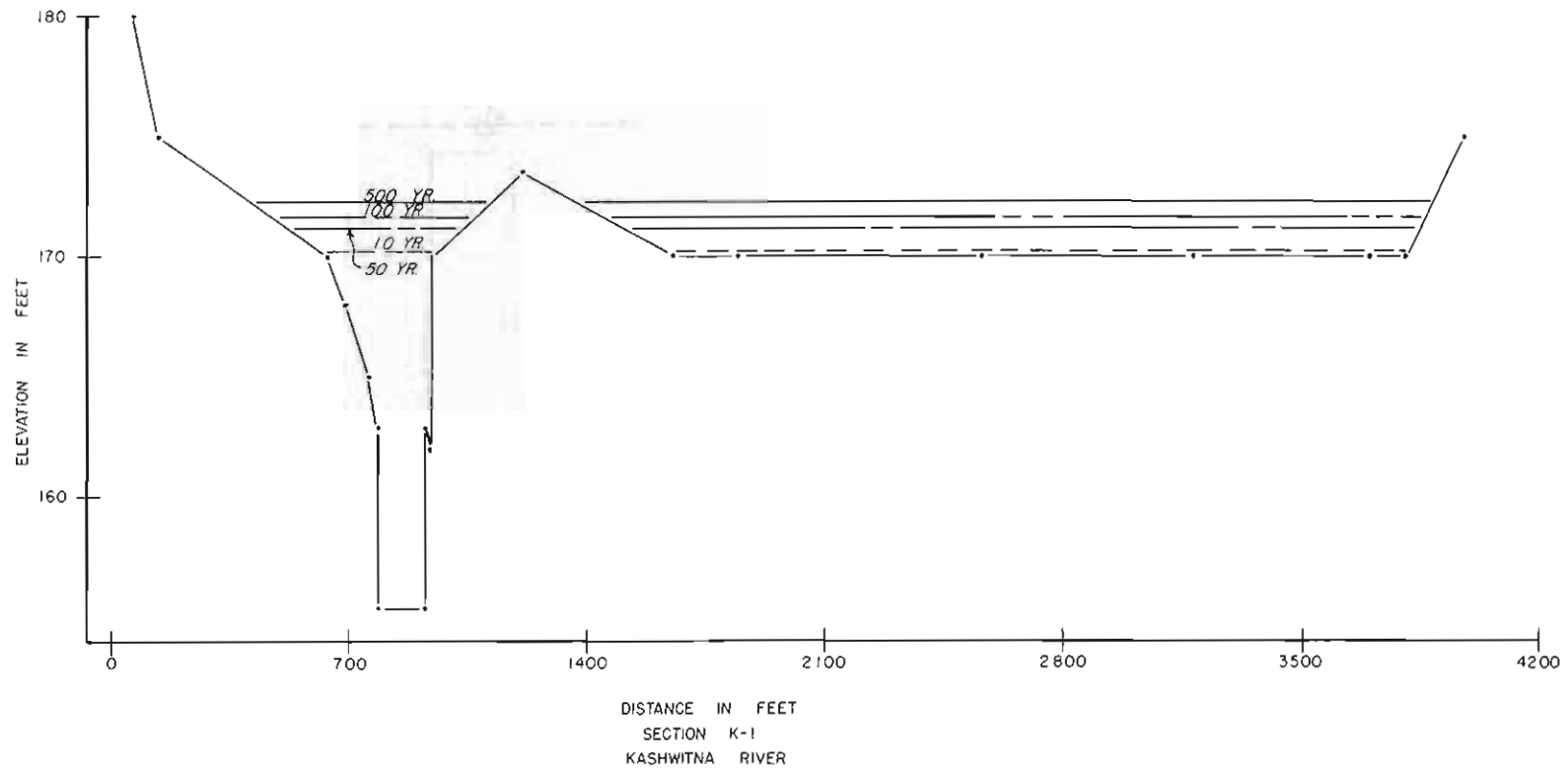

SOIL CONSERVATION SERVICE
U. S. DEPARTMENT OF AGRICULTURE
TALKEETNA SUBBASIN
MATANUSKA-SUSITNA BOROUGH, ALASKA
FIGURE 10

TYPICAL VALLEY SECTION
PRESENT CONDITIONS

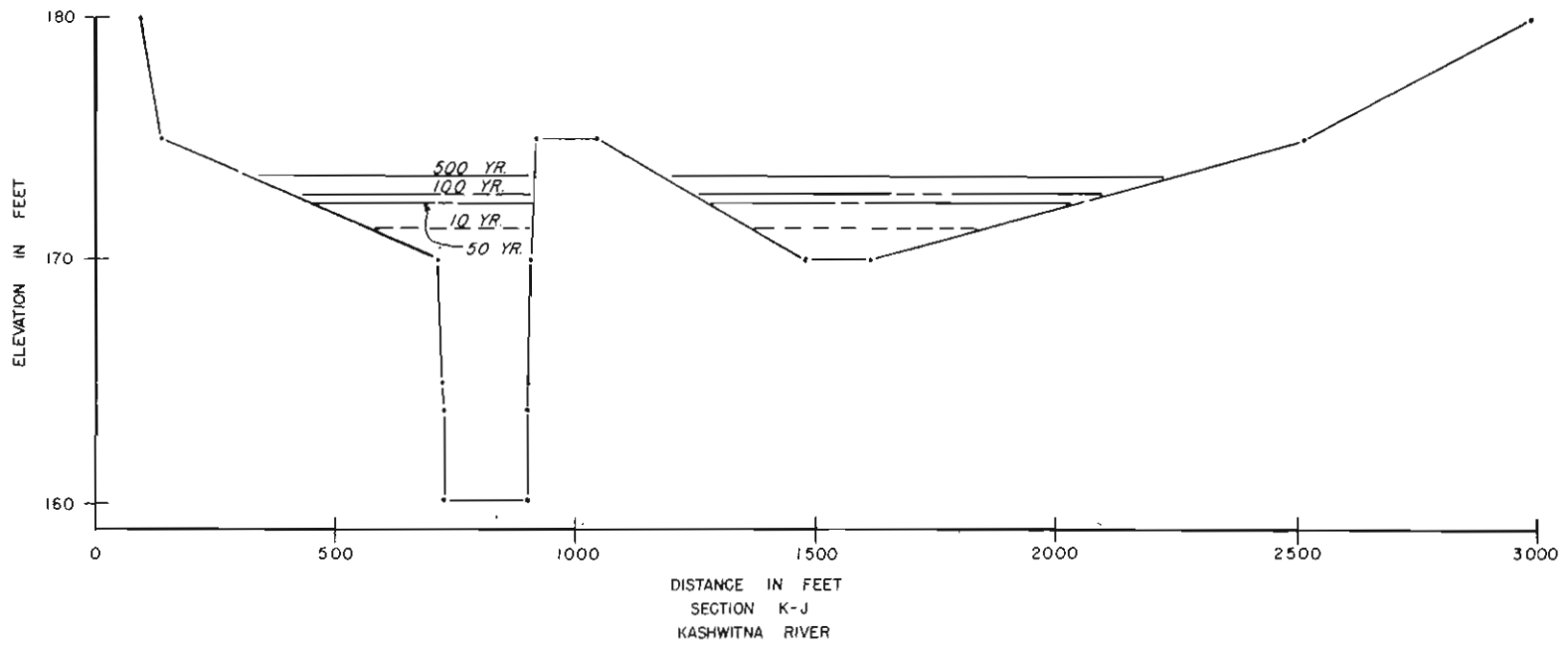

SOIL CONSERVATION SERVICE
U.S. DEPARTMENT OF AGRICULTURE
TALKEETNA SUBBASIN
MATANUSKA - SUSITNA BOROUGH, ALASKA

FIGURE 11

TYPICAL VALLEY SECTION
PRESENT CONDITIONS

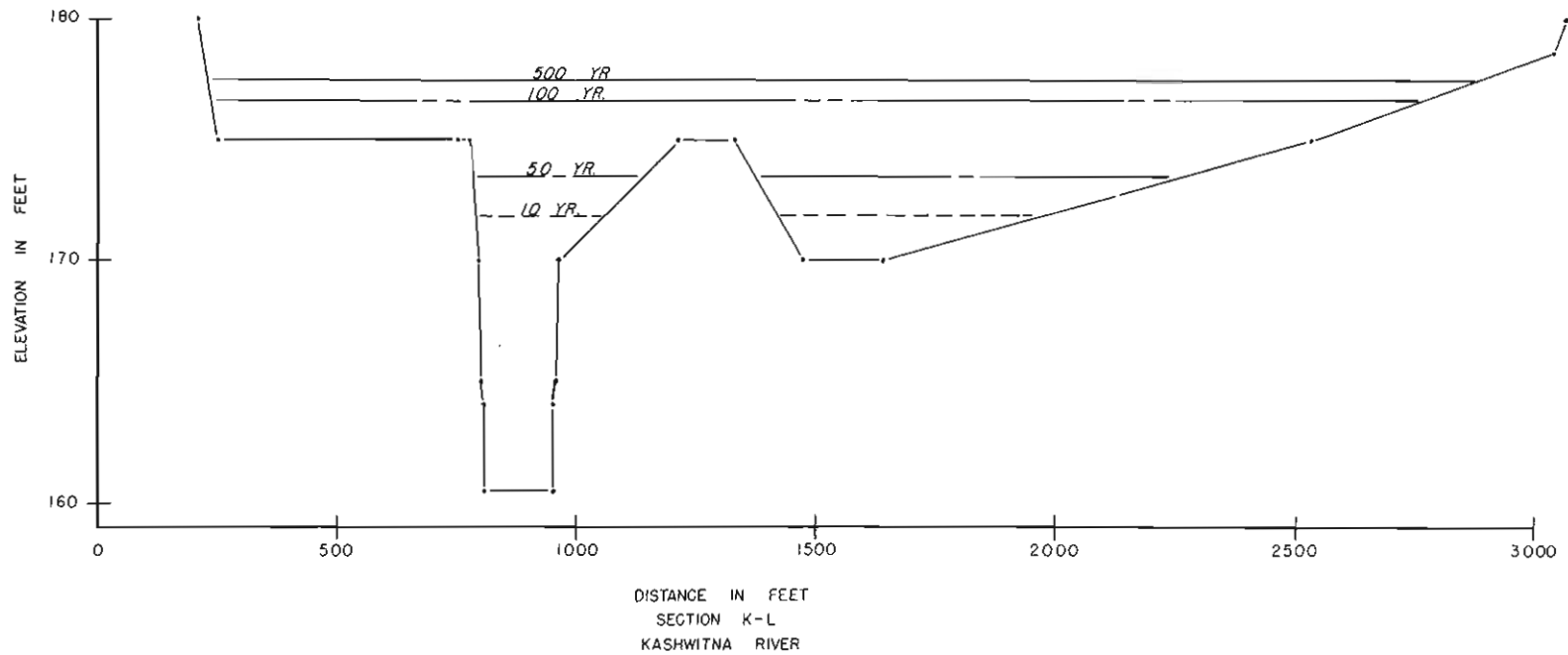

SOIL CONSERVATION SERVICE
U. S. DEPARTMENT OF AGRICULTURE
TALKEETNA SUBBASIN
MATANUSKA-SUSITNA BOROUGH, ALASKA

FIGURE 13

TYPICAL VALLEY SECTION
PRESENT CONDITIONS

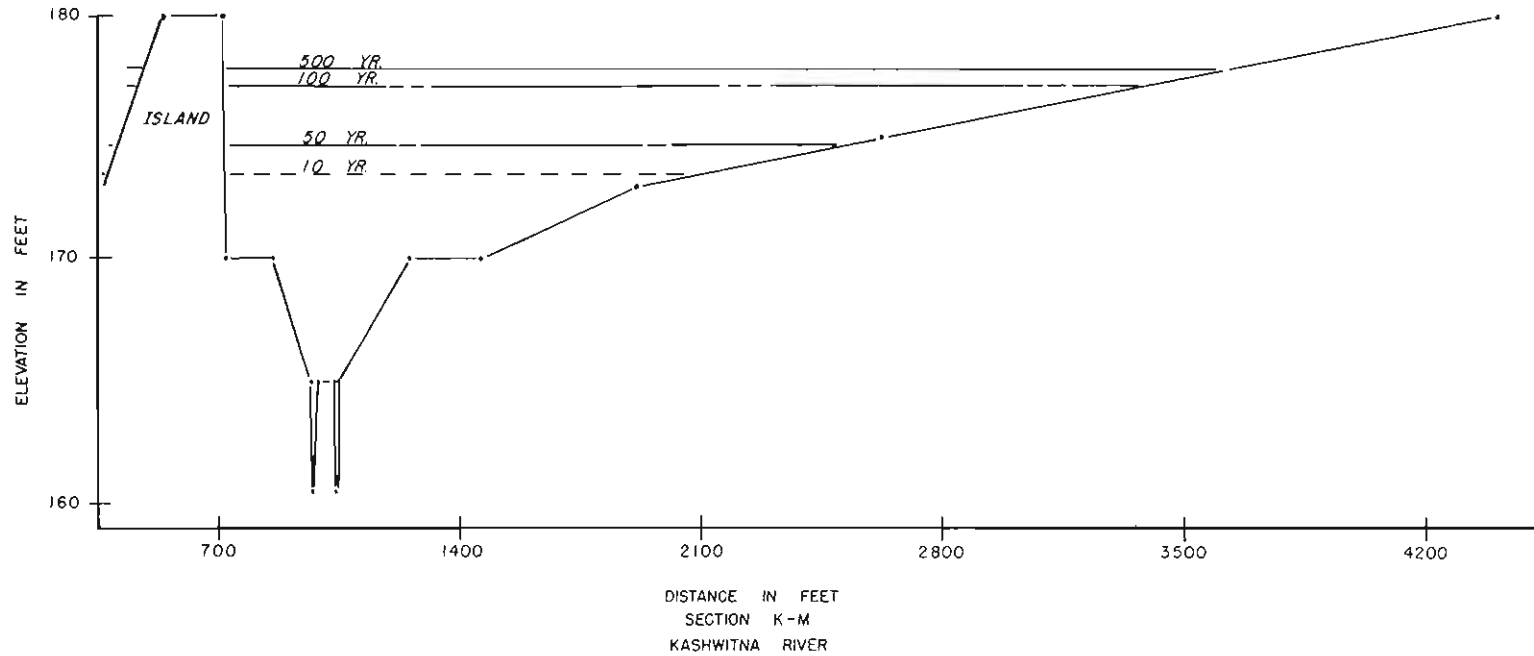

SOIL CONSERVATION SERVICE
U.S. DEPARTMENT OF AGRICULTURE
TALKEETNA SUBBASIN
MATANUSKA-SUSITNA BOROUGH, ALASKA
FIGURE 14

TYPICAL VALLEY SECTION
PRESENT CONDITIONS

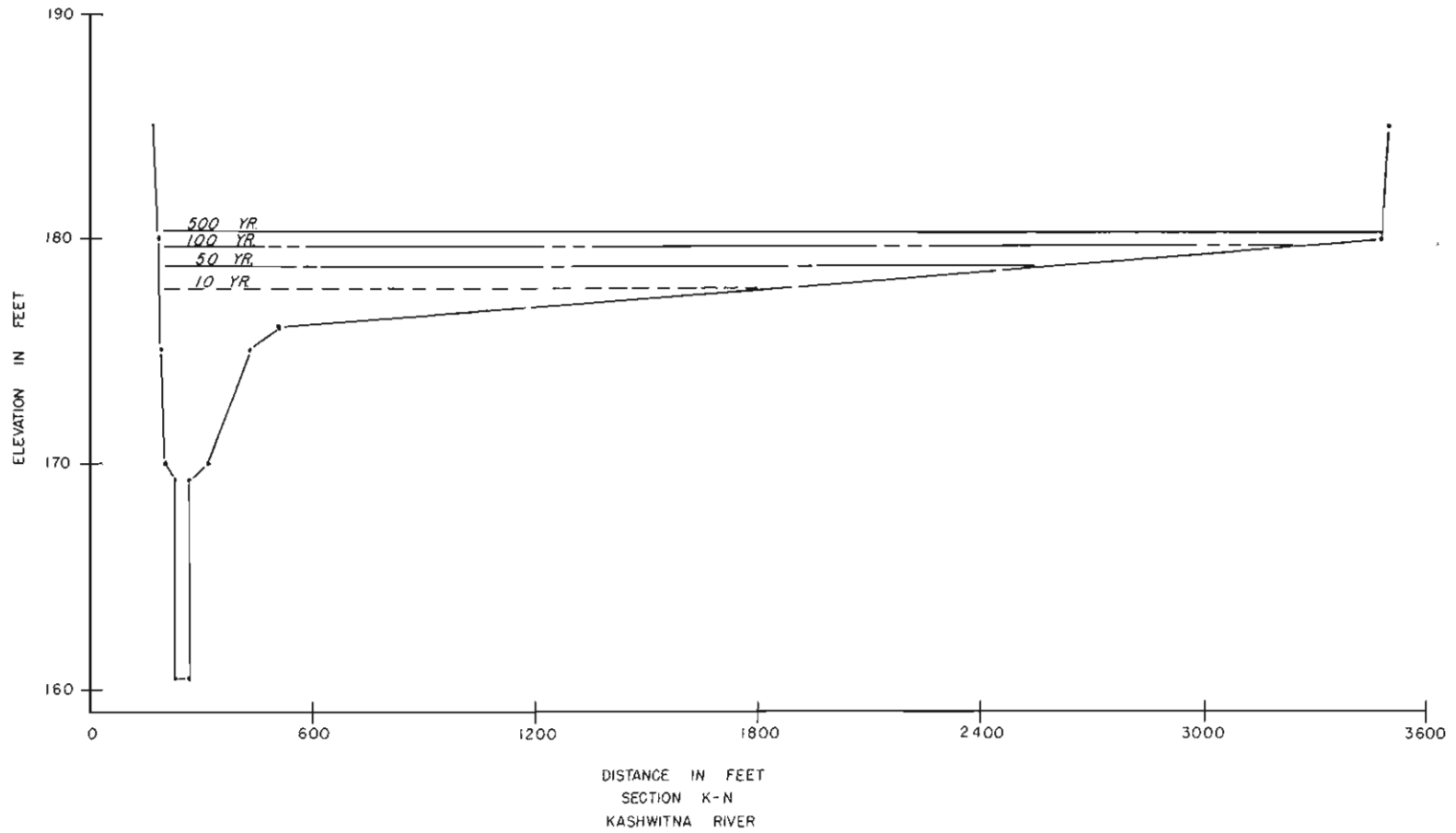

SOIL CONSERVATION SERVICE
U.S. DEPARTMENT OF AGRICULTURE
TALKEETNA SUBBASIN
MATANUSKA-SUSITNA BOROUGH, ALASKA
FIGURE 15

TYPICAL VALLEY SECTION
PRESENT CONDITIONS

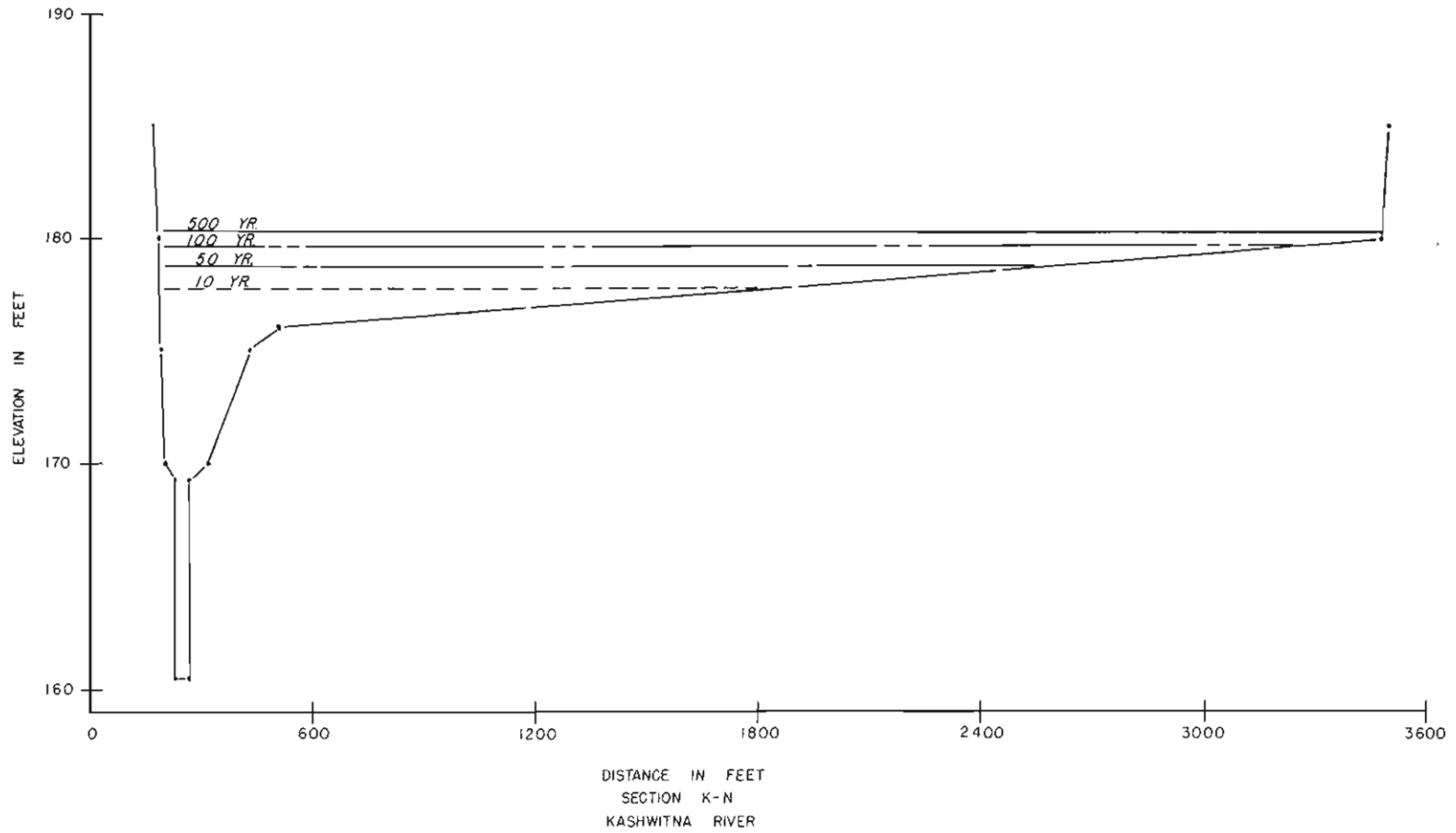

SOIL CONSERVATION SERVICE
U.S. DEPARTMENT OF AGRICULTURE
TALKEETNA SUBBASIN
MATANUSKA-SUSITNA BOROUGH, ALASKA
FIGURE 15

TYPICAL VALLEY SECTION
PRESENT CONDITIONS

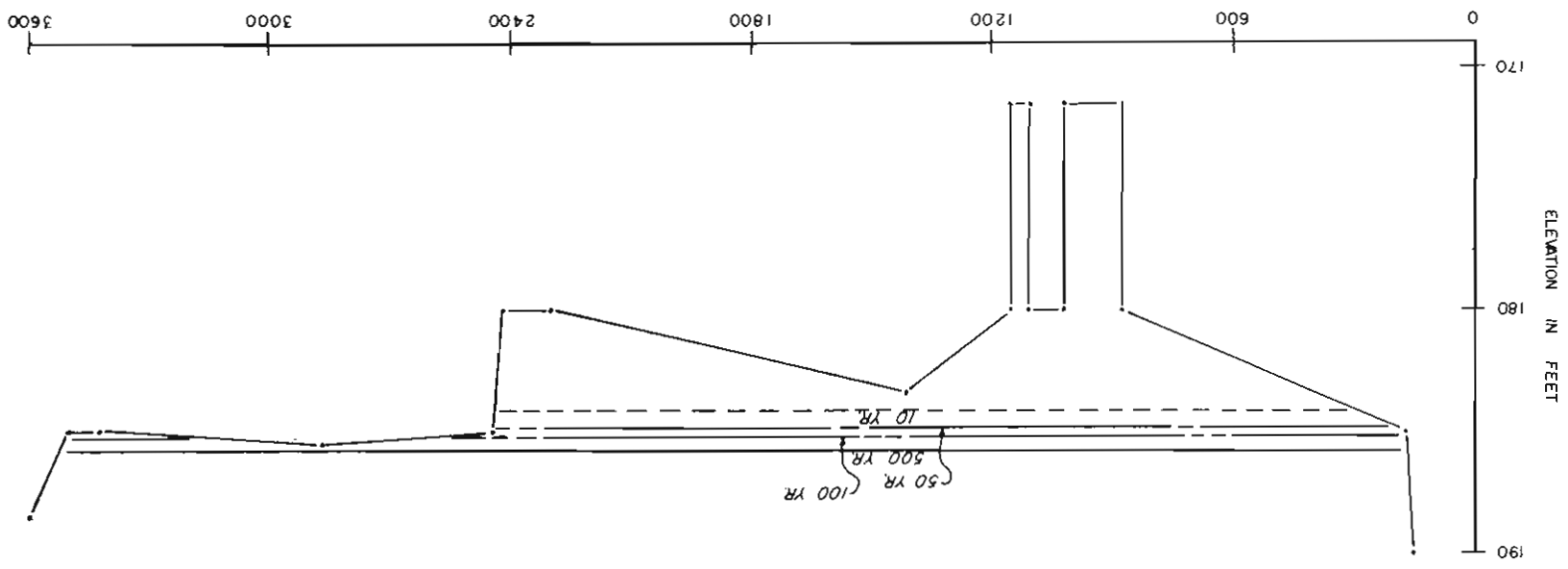

KASHWITNA RIVER
SECTION K-P
DISTANCE IN FEET

SOIL CONSERVATION SERVICE
U.S. DEPARTMENT OF AGRICULTURE
TALKEETNA SUBBASIN
MATANUSKA - SUSITNA BOROUGH, ALASKA

FIGURE 17

TYPICAL VALLEY SECTION
PRESENT CONDITIONS

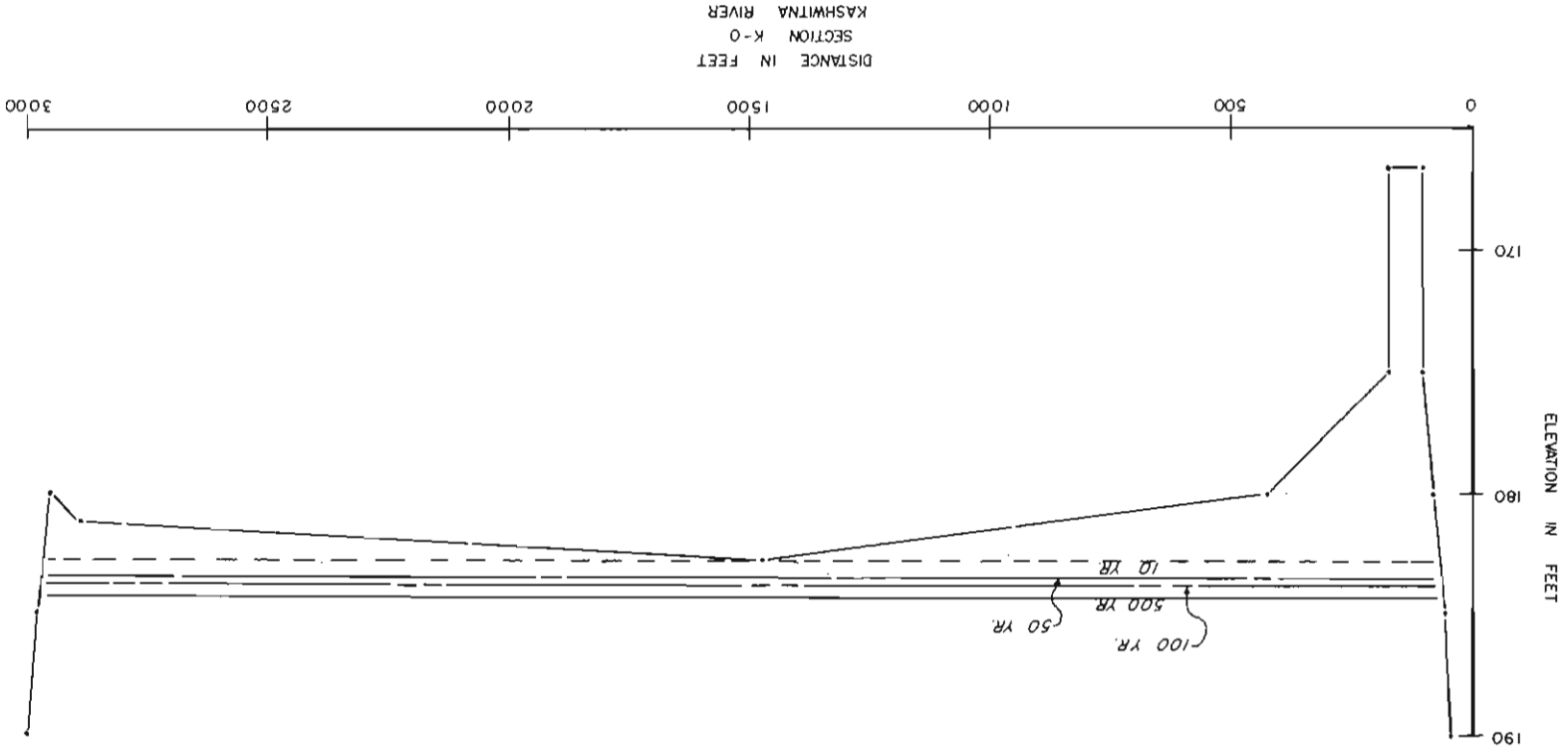

SECTION K-0
KASHWITNA RIVER

SOIL CONSERVATION SERVICE
U. S. DEPARTMENT OF AGRICULTURE
TALKEETNA SUBBASIN
MATANUSKA - SUSITNA BOROUGH, ALASKA

FIGURE 16

TYPICAL VALLEY SECTION
PRESENT CONDITIONS

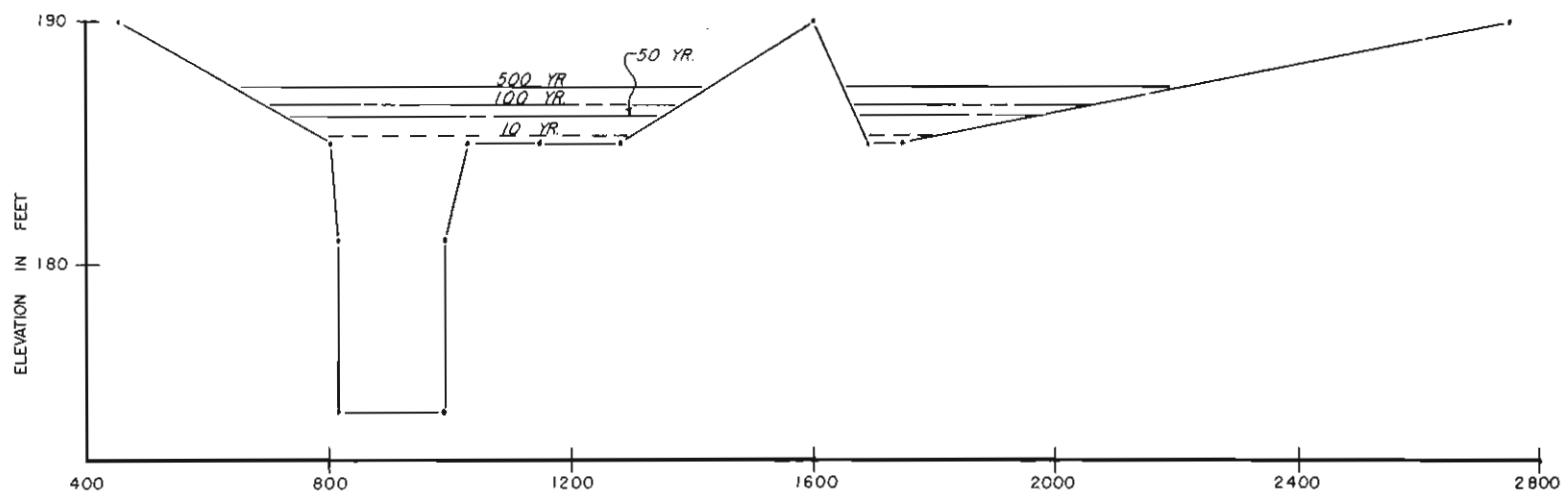

DISTANCE IN FEET
SECTION K-Q
KASHWITNA RIVER

SOIL CONSERVATION SERVICE
U.S. DEPARTMENT OF AGRICULTURE
TALKEETNA SUBBASIN
MATANUSKA-SUSITNA BOROUGH, ALASKA
FIGURE 18

TYPICAL VALLEY SECTION
PRESENT CONDITIONS

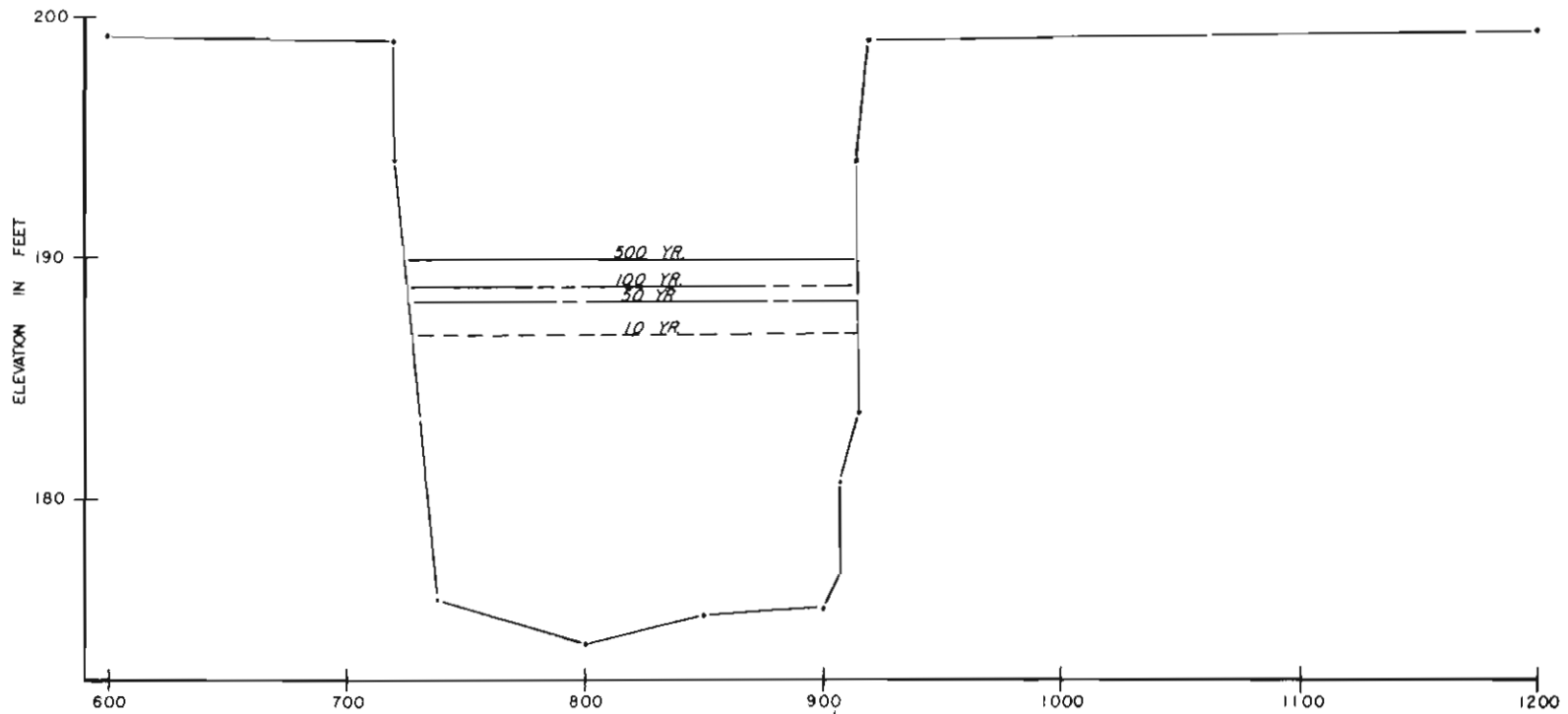

DISTANCE IN FEET
SECTION K-RRR
KASHWITNA RIVER

SOIL CONSERVATION SERVICE
U.S. DEPARTMENT OF AGRICULTURE
TALKEETNA SUBBASIN
MATANUSKA-SUSITNA BOROUGH, ALASKA

FIGURE 19

TYPICAL VALLEY SECTION
PRESENT CONDITIONS

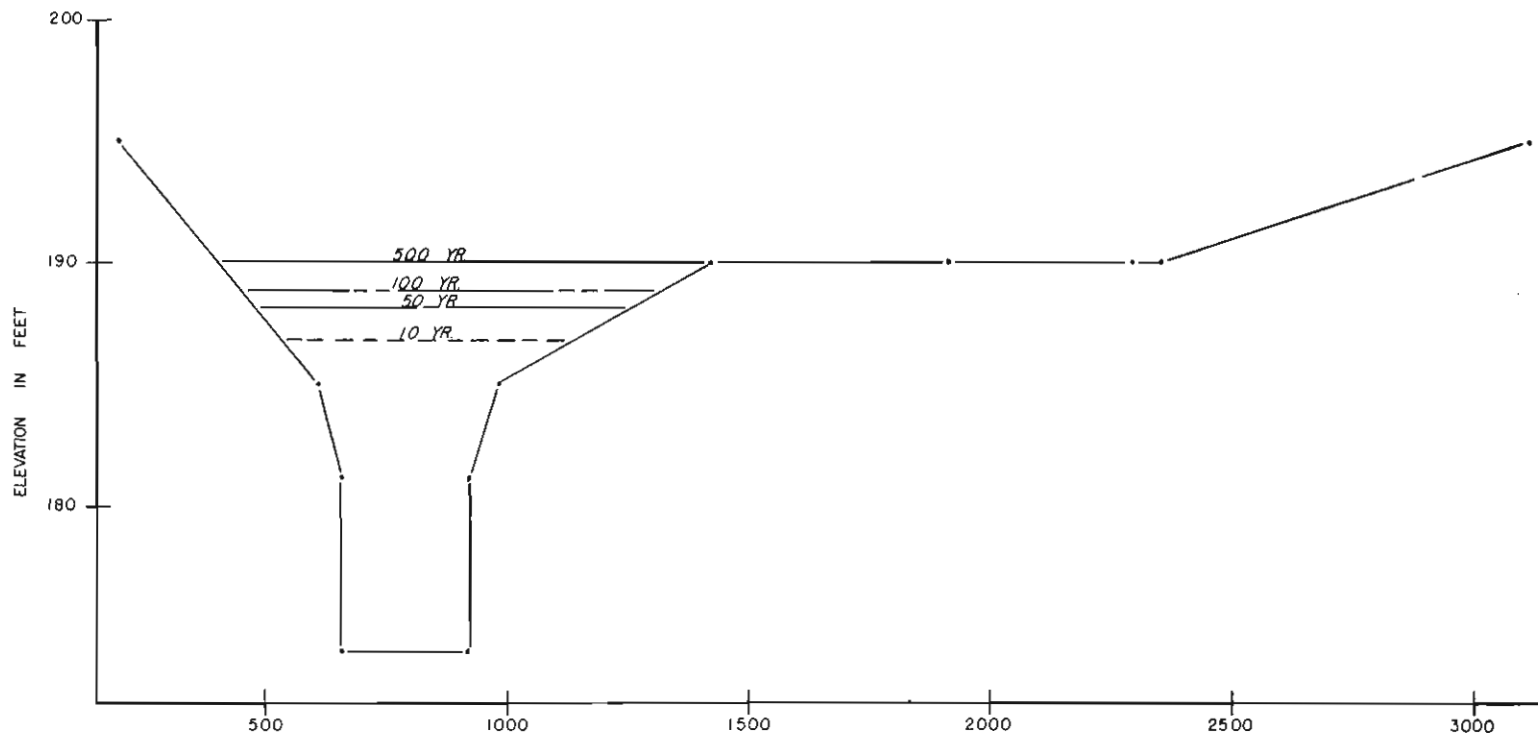

DISTANCE IN FEET
SECTION K-S
KASHWITNA RIVER

SOIL CONSERVATION SERVICE
U. S. DEPARTMENT OF AGRICULTURE
TALKEETNA SUBBASIN
MATANUSKA - SUSITNA BOROUGH, ALASKA
FIGURE 20

TYPICAL VALLEY SECTION
PRESENT CONDITIONS

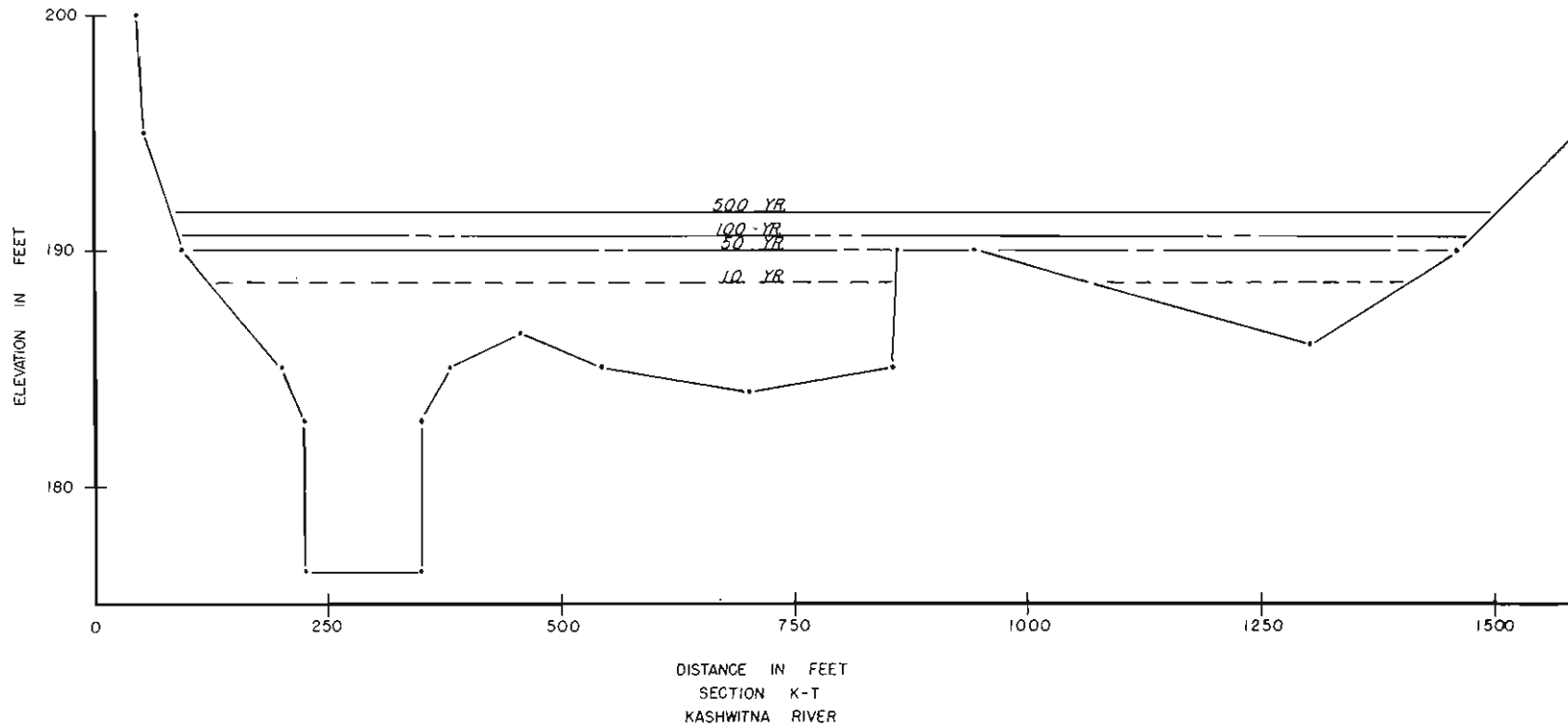

SOIL CONSERVATION SERVICE
U.S. DEPARTMENT OF AGRICULTURE
TALKEETNA SUBBASIN
MATANUSKA - SUSITNA BOROUGH, ALASKA
FIGURE 21

TYPICAL VALLEY SECTION
PRESENT CONDITIONS

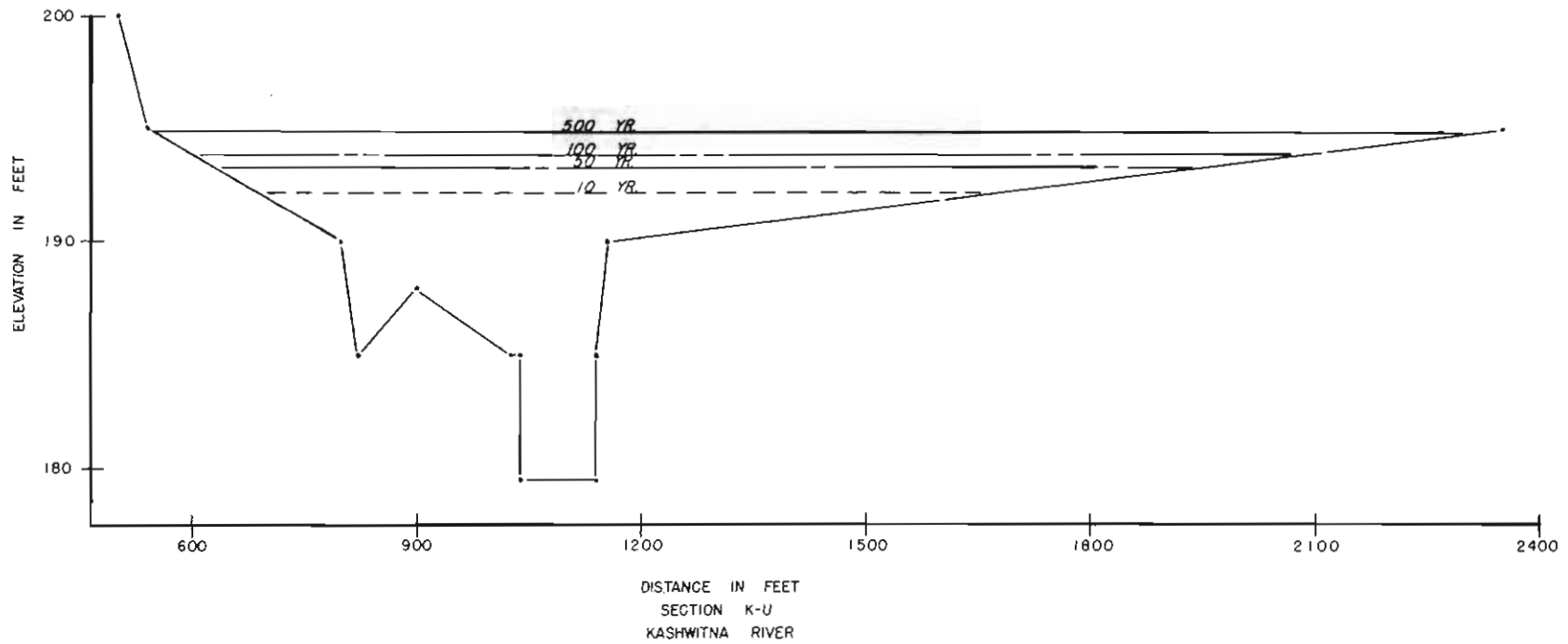

SOIL CONSERVATION SERVICE
U.S. DEPARTMENT OF AGRICULTURE
TALKEETNA SUBBASIN
MATANUSKA-SUSITNA BOROUGH, ALASKA
FIGURE 22

TYPICAL VALLEY SECTION
PRESENT CONDITIONS

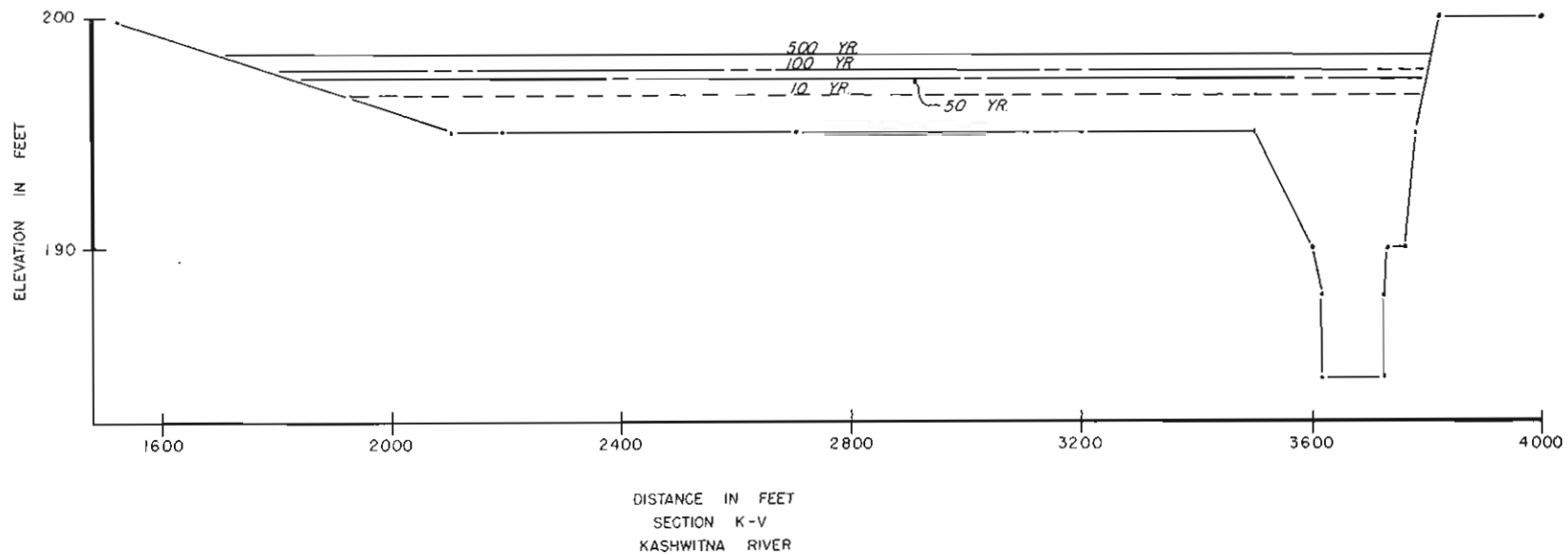

SOIL CONSERVATION SERVICE
U. S. DEPARTMENT OF AGRICULTURE
TALKEETNA SUBBASIN
MATANUSKA-SUSITNA BOROUGH, ALASKA

TYPICAL VALLEY SECTION
PRESENT CONDITIONS

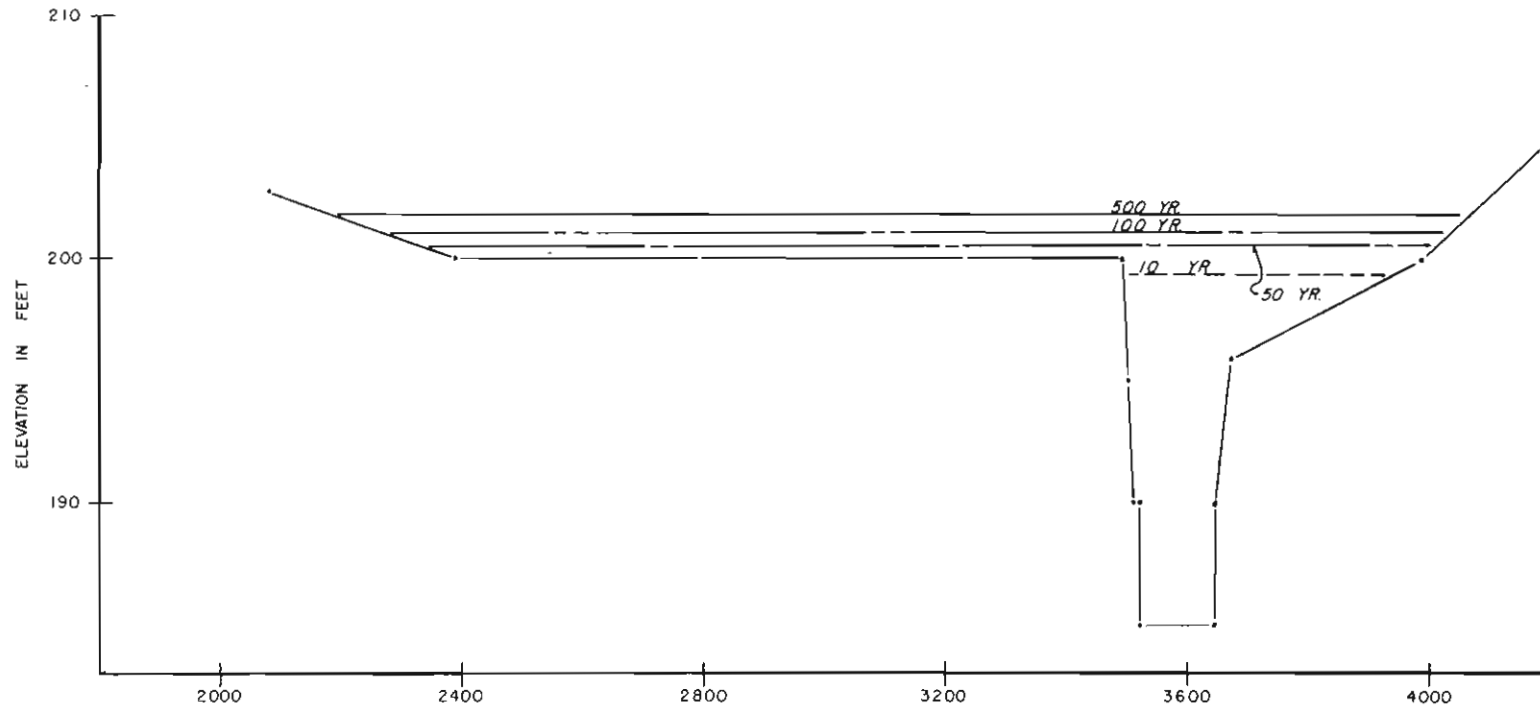

DISTANCE IN FEET
SECTION K-W
KASHWITNA RIVER

SOIL CONSERVATION SERVICE
U. S. DEPARTMENT OF AGRICULTURE
TALKEETNA SUBBASIN
MATANUSKA-SUSITNA BOROUGH, ALASKA

FIGURE 24

TYPICAL VALLEY SECTION
PRESENT CONDITIONS

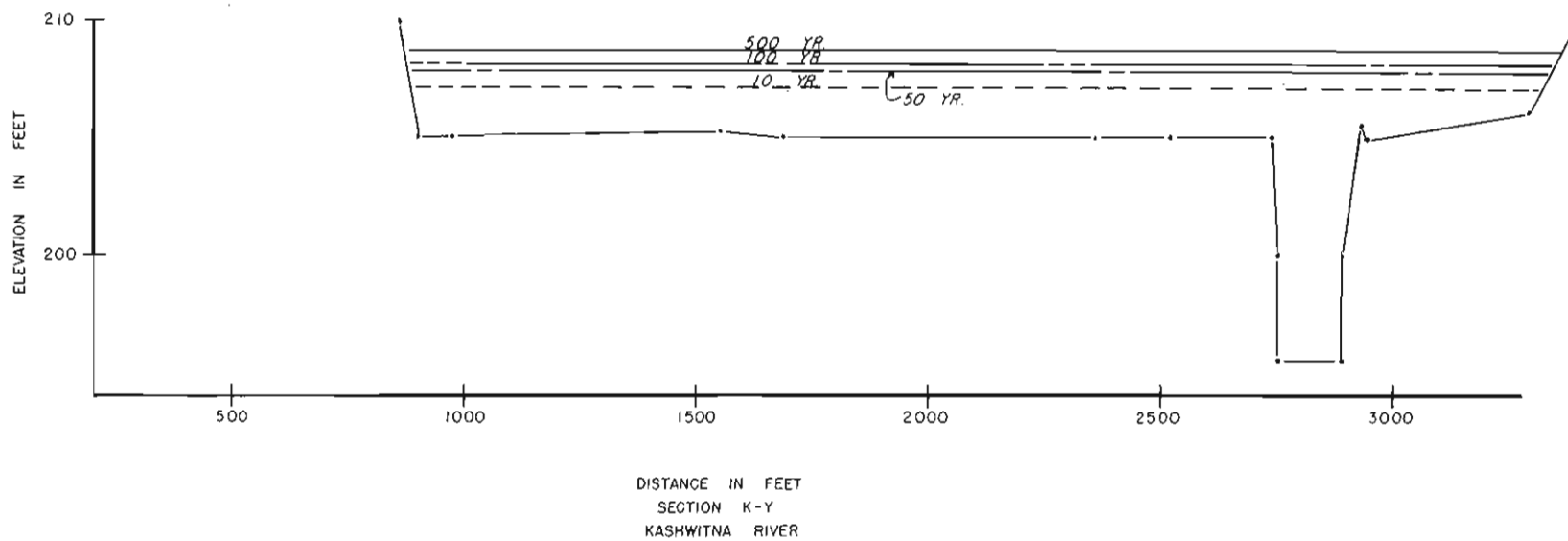

SOIL CONSERVATION SERVICE
U.S. DEPARTMENT OF AGRICULTURE
TALKEETNA SUBBASIN
MATANUSKA-SUSITNA BOROUGH, ALASKA

TYPICAL VALLEY SECTION
PRESENT CONDITIONS

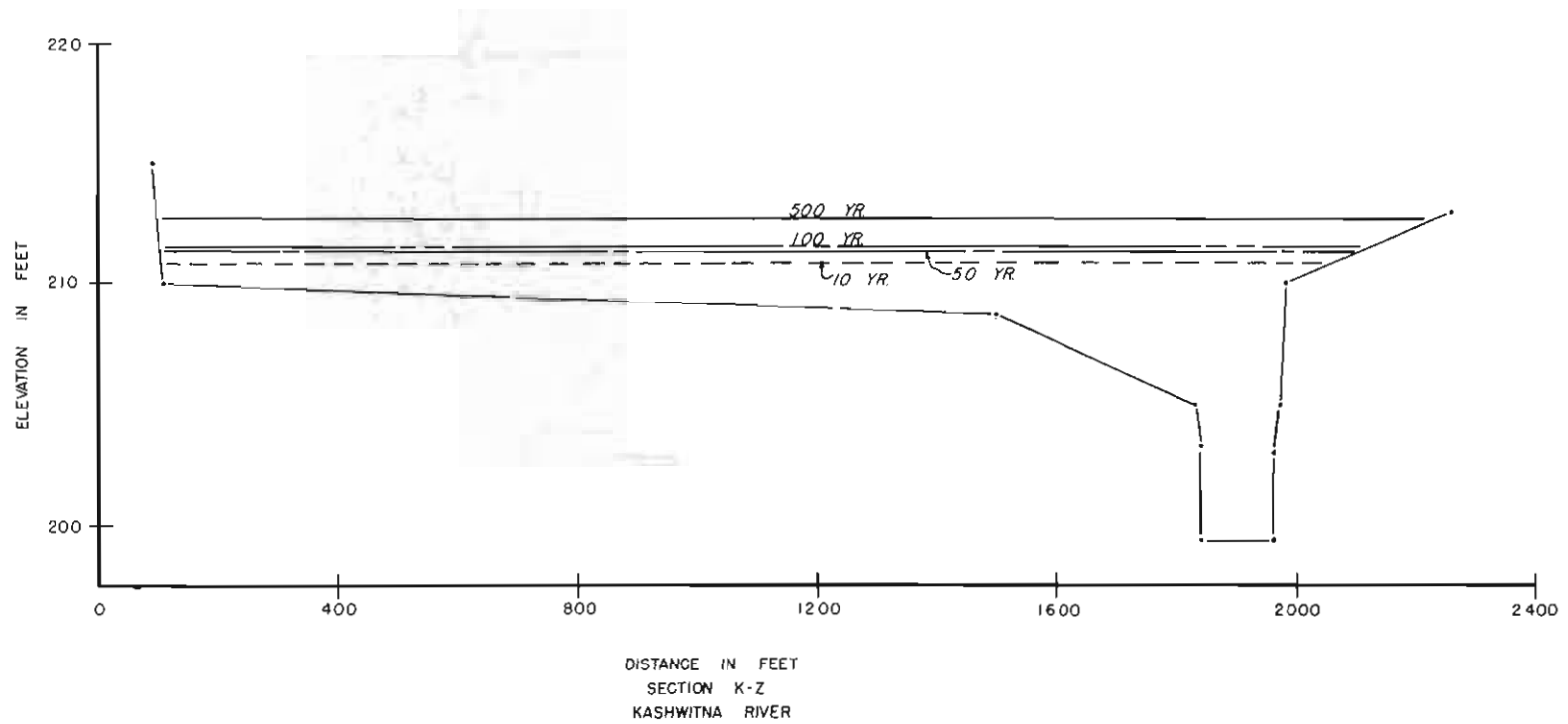

SOIL CONSERVATION SERVICE
U.S. DEPARTMENT OF AGRICULTURE
TALKEETNA SUBBASIN
MATANUSKA-SUSITNA BOROUGH, ALASKA

TYPICAL VALLEY SECTION
PRESENT CONDITIONS

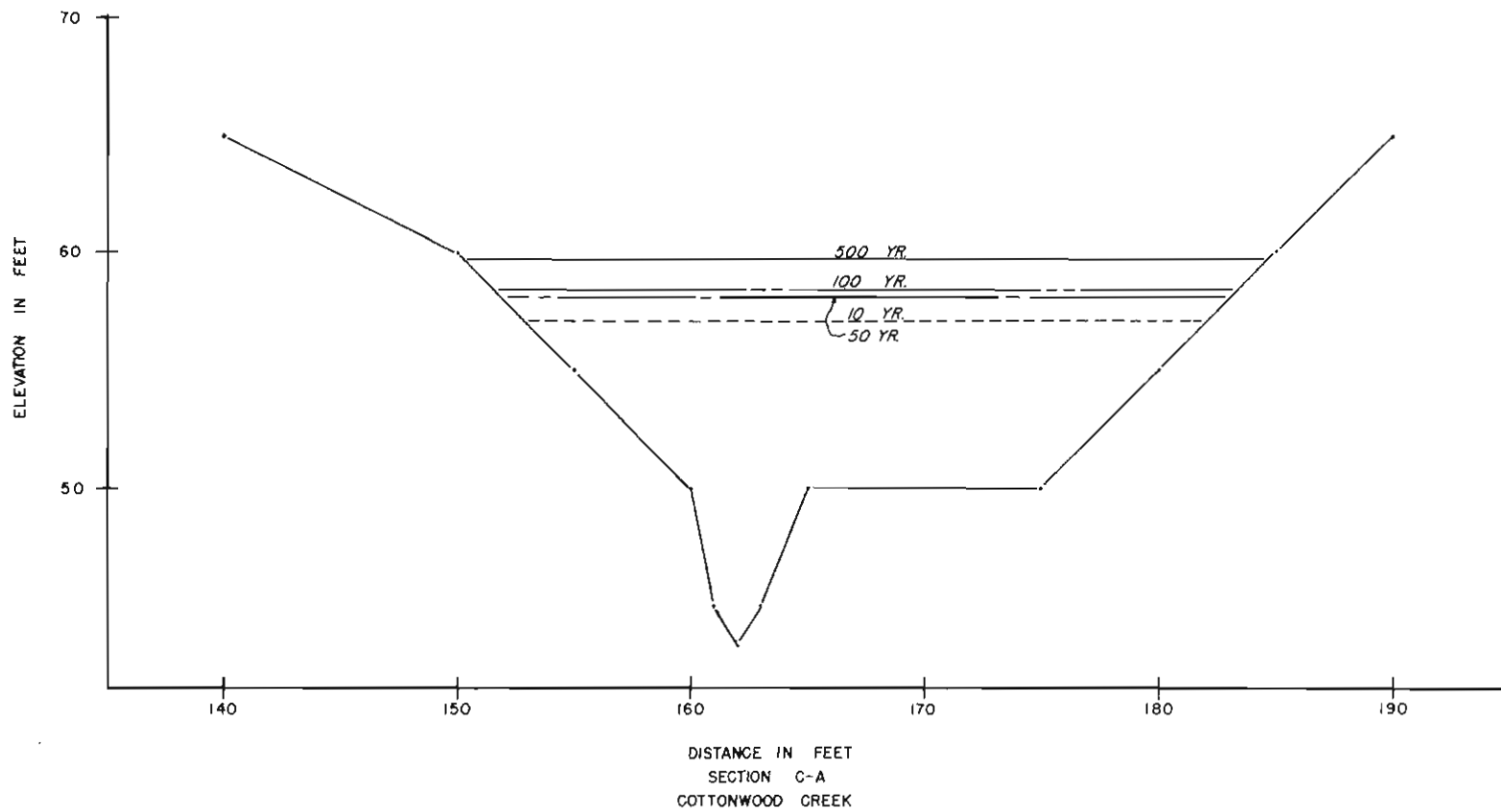

SOIL CONSERVATION SERVICE
U.S. DEPARTMENT OF AGRICULTURE
TALKEETNA SUBBASIN -
MATANUSKA-SUSITNA BOROUGH, ALASKA

FIGURE 27

TYPICAL VALLEY SECTION
PRESENT CONDITIONS

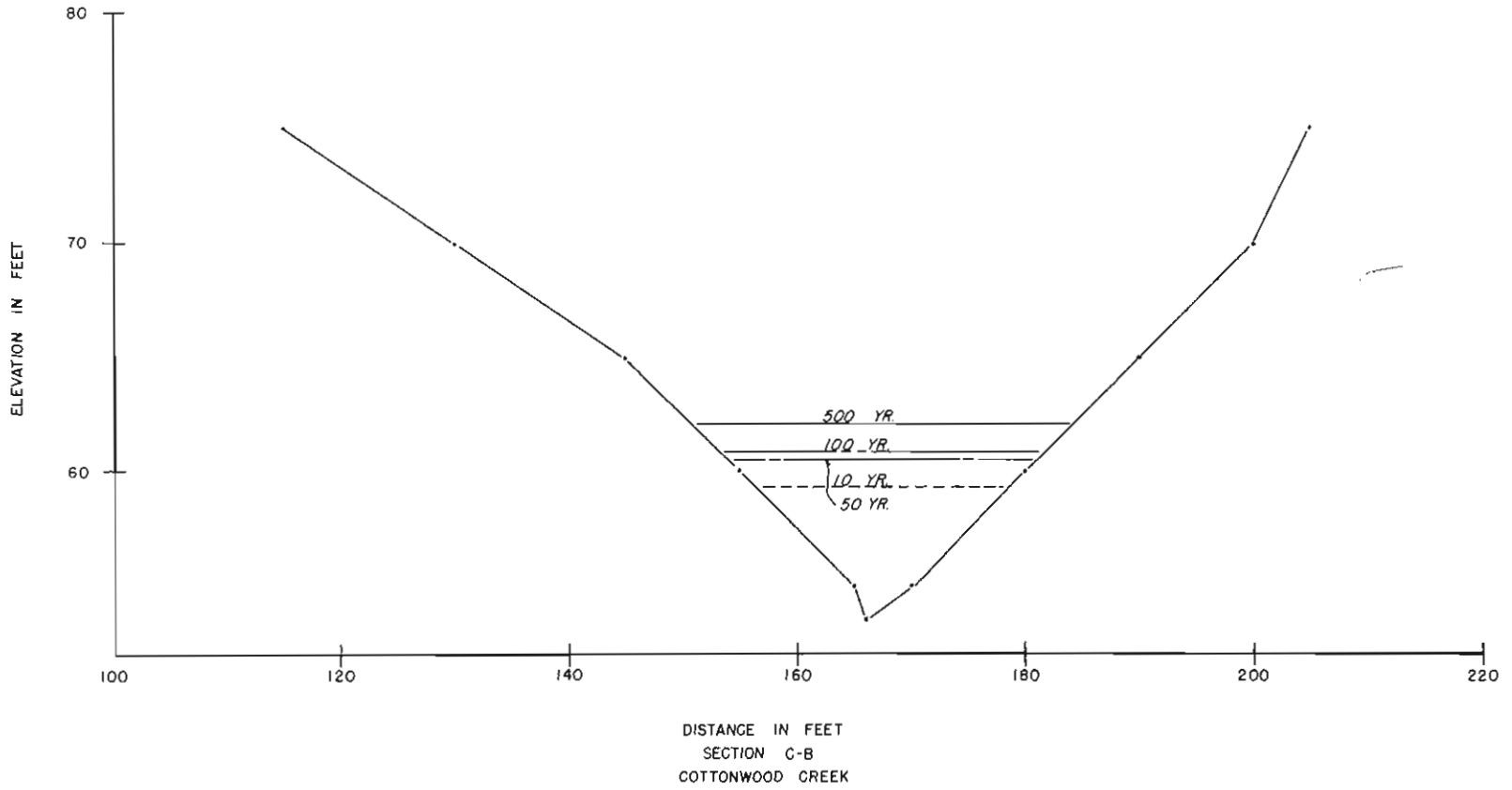

SOIL CONSERVATION SERVICE
U.S. DEPARTMENT OF AGRICULTURE
TALKEETNA SUBBASIN
MATANUSKA - SUSITNA BOROUGH, ALASKA

FIGURE 2B

TYPICAL VALLEY SECTION
PRESENT CONDITIONS

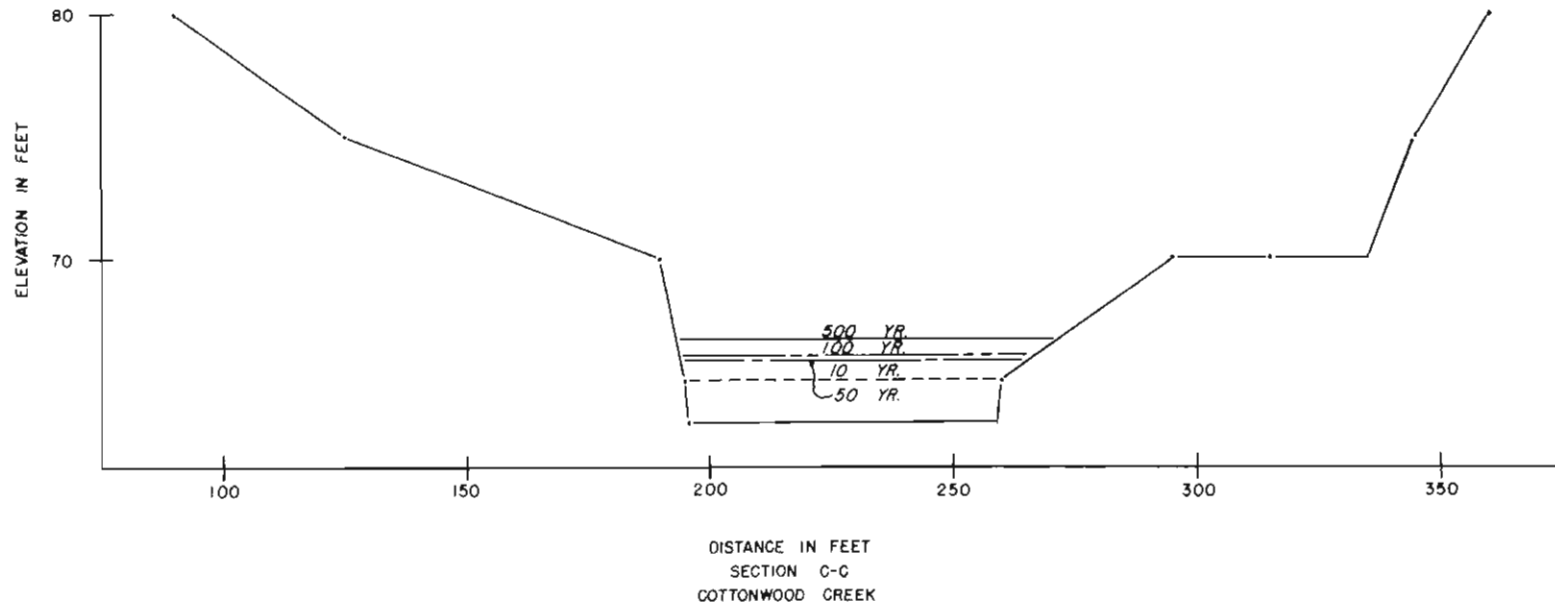

SOIL CONSERVATION SERVICE
U.S. DEPARTMENT OF AGRICULTURE
TALKEETNA SUBBASIN
MATANUSKA-SUSITNA BOROUGH, ALASKA

FIGURE 29

TYPICAL VALLEY SECTION
PRESENT CONDITIONS

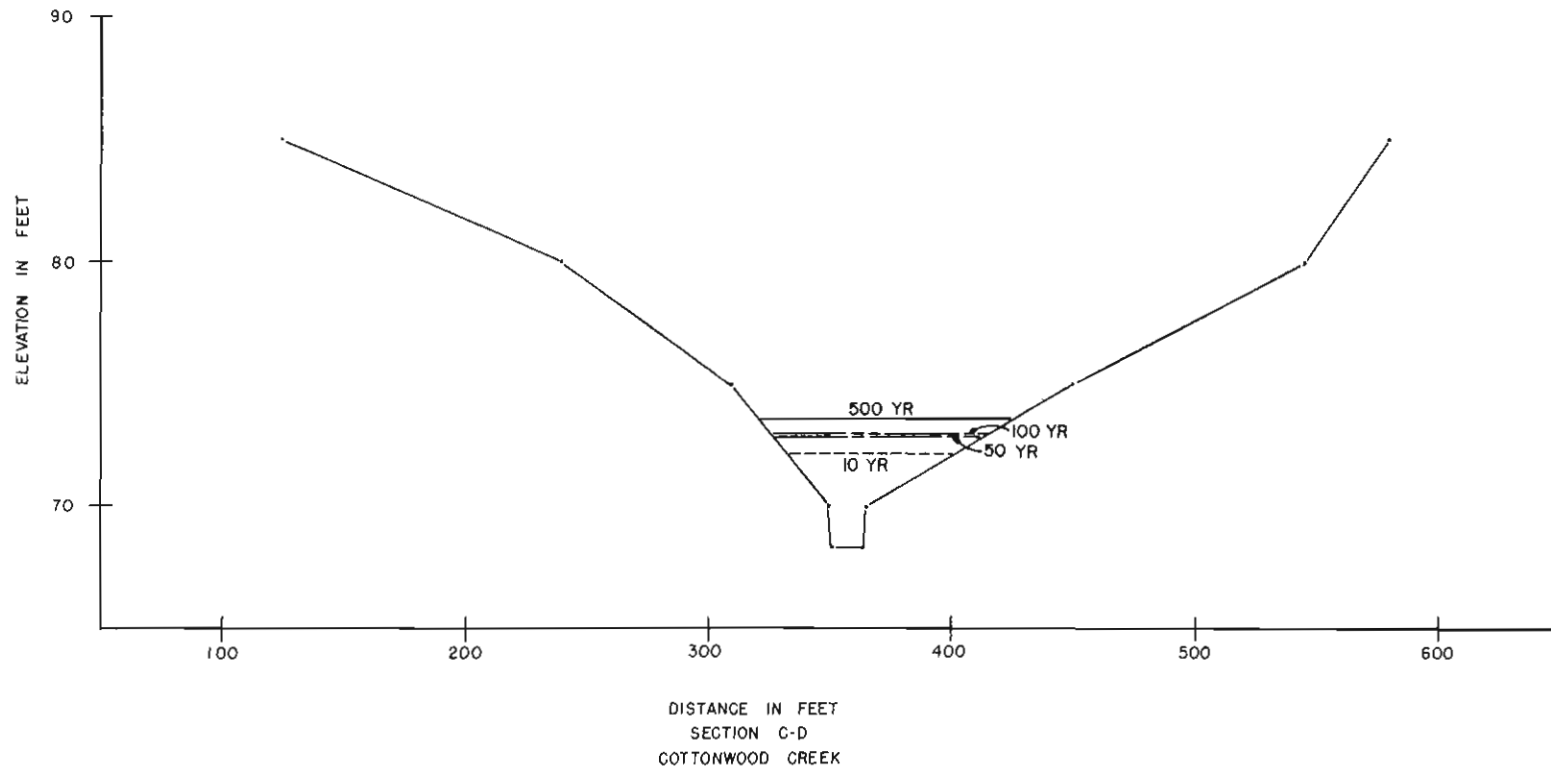

SOIL CONSERVATION SERVICE
U.S. DEPARTMENT OF AGRICULTURE
TALKEETNA SUBBASIN
MATANUSKA-SUSITNA BOROUGH, ALASKA

FIGURE 30

TYPICAL VALLEY SECTION
PRESENT CONDITIONS

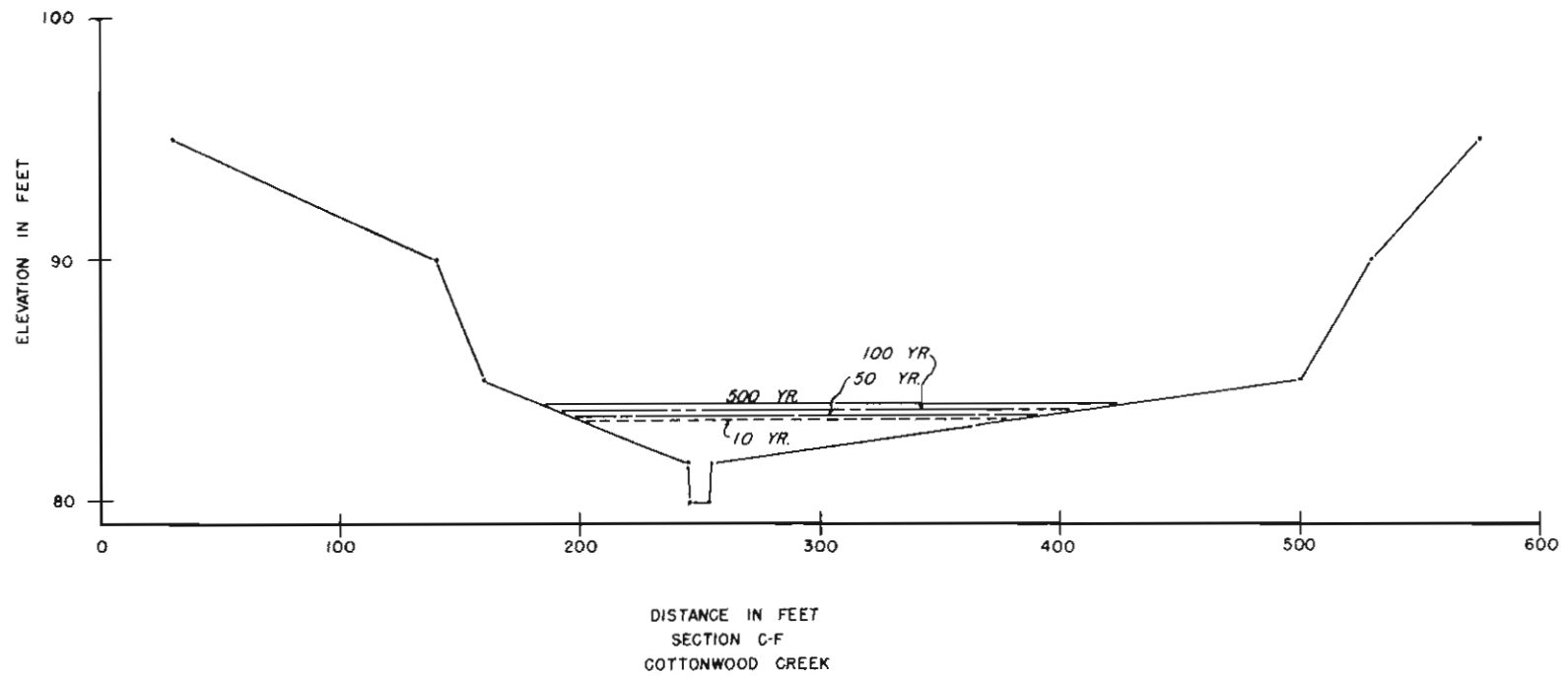

SOIL CONSERVATION SERVICE
U.S. DEPARTMENT OF AGRICULTURE
TALKEETNA SUBBASIN
MATANUSKA-SUSITNA BOROUGH, ALASKA

FIGURE 32

TYPICAL VALLEY SECTION
PRESENT CONDITIONS

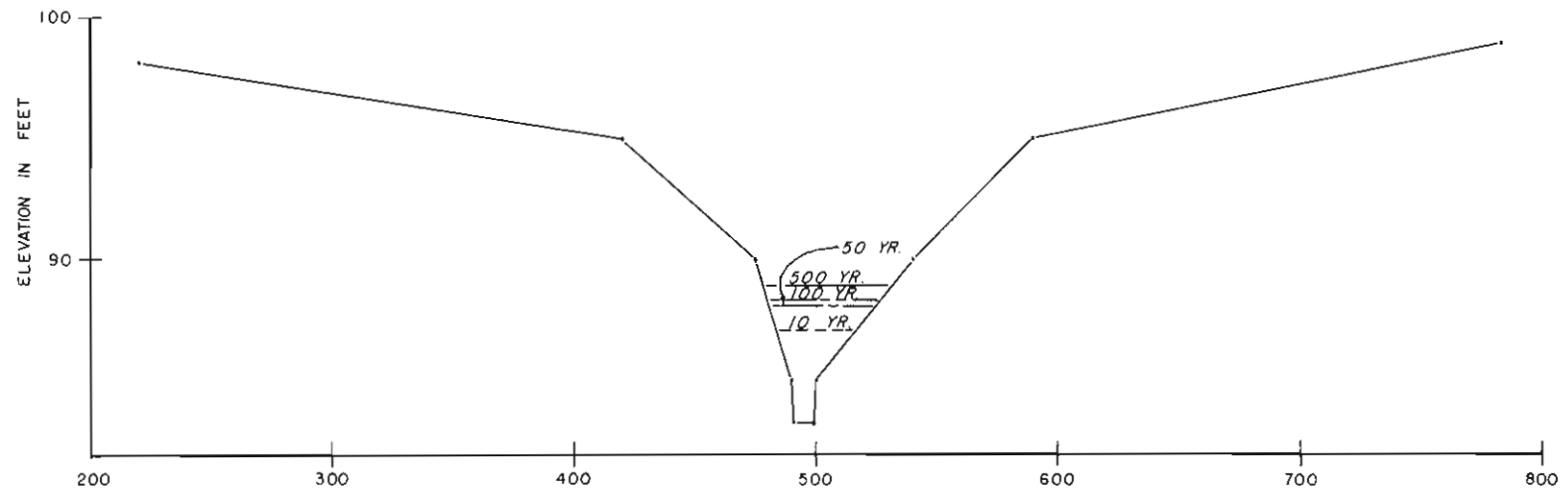

DISTANCE IN FEET
SECTION C-G
COTTONWOOD CREEK

SOIL CONSERVATION SERVICE
U.S. DEPARTMENT OF AGRICULTURE
TALKEETNA SUBBASIN
MATANUSKA - SUSITNA BOROUGH, ALASKA

FIGURE 33

TYPICAL VALLEY SECTION
PRESENT CONDITIONS

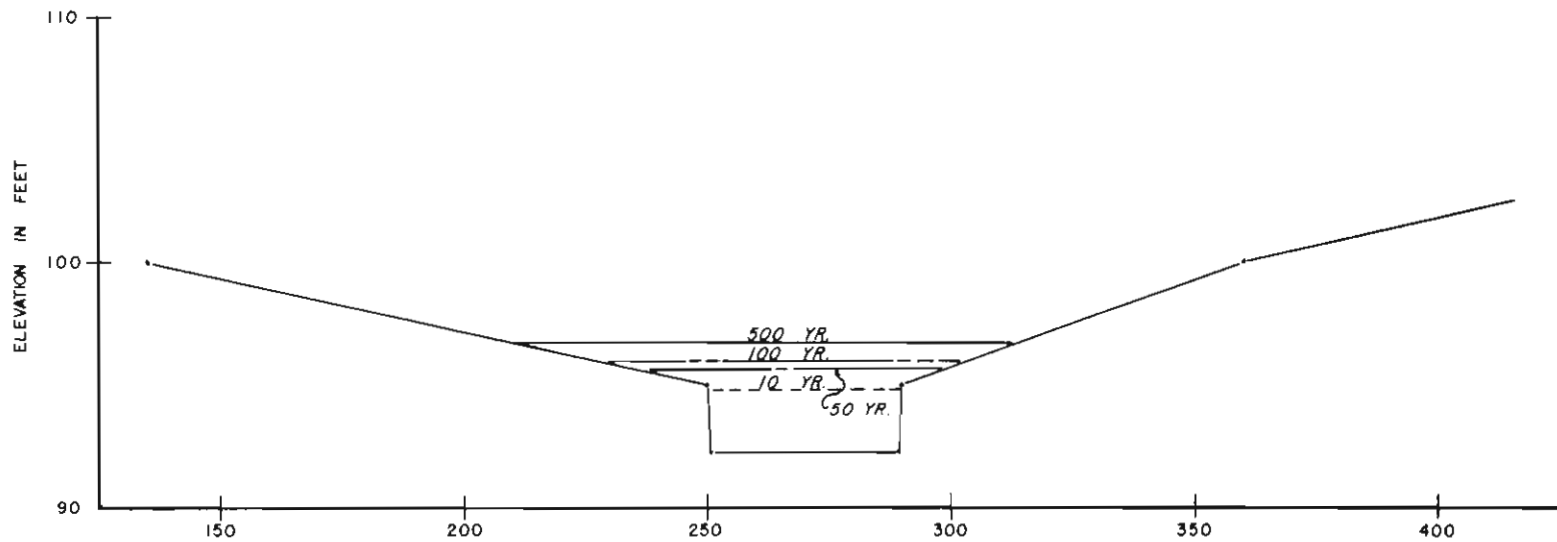

DISTANCE IN FEET
SECTION C-H
COTTONWOOD CREEK

SOIL CONSERVATION SERVICE
U.S. DEPARTMENT OF AGRICULTURE
TALKEETNA SUBBASIN
MATANUSKA-SUSITNA BOROUGH, ALASKA

FIGURE 34

TYPICAL VALLEY SECTION
PRESENT CONDITION

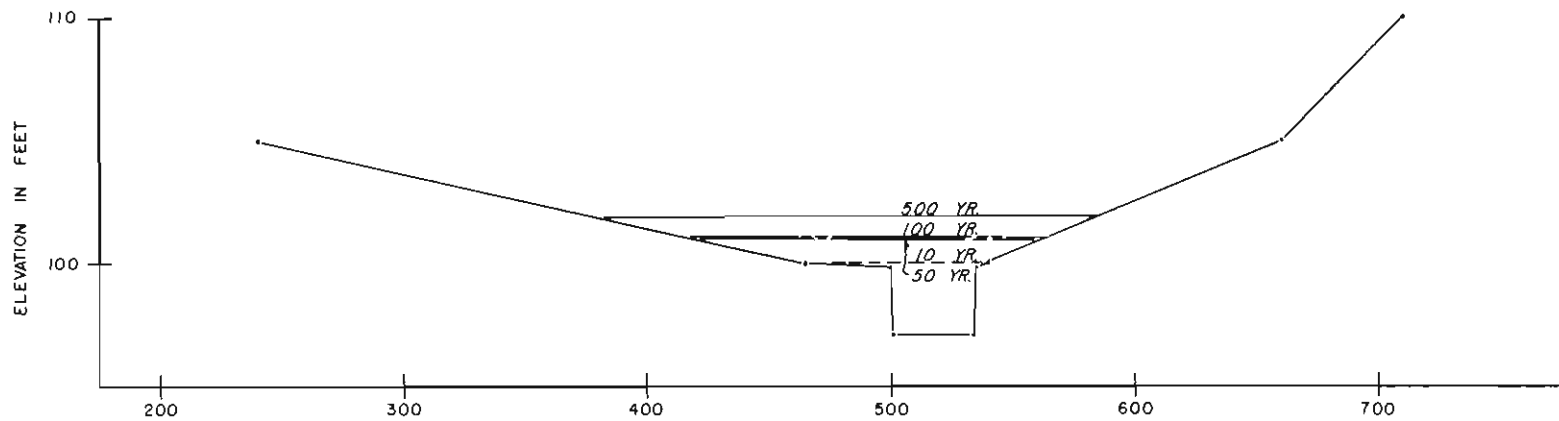

DISTANCE IN FEET
SECTION C-1
COTTONWOOD CREEK

SOIL CONSERVATION SERVICE
U.S. DEPARTMENT OF AGRICULTURE
TALKEETNA SUBBASIN
MATANUSKA-SUSITNA BOROUGH, ALASKA

FIGURE 35

TYPICAL VALLEY SECTION
PRESENT CONDITIONS

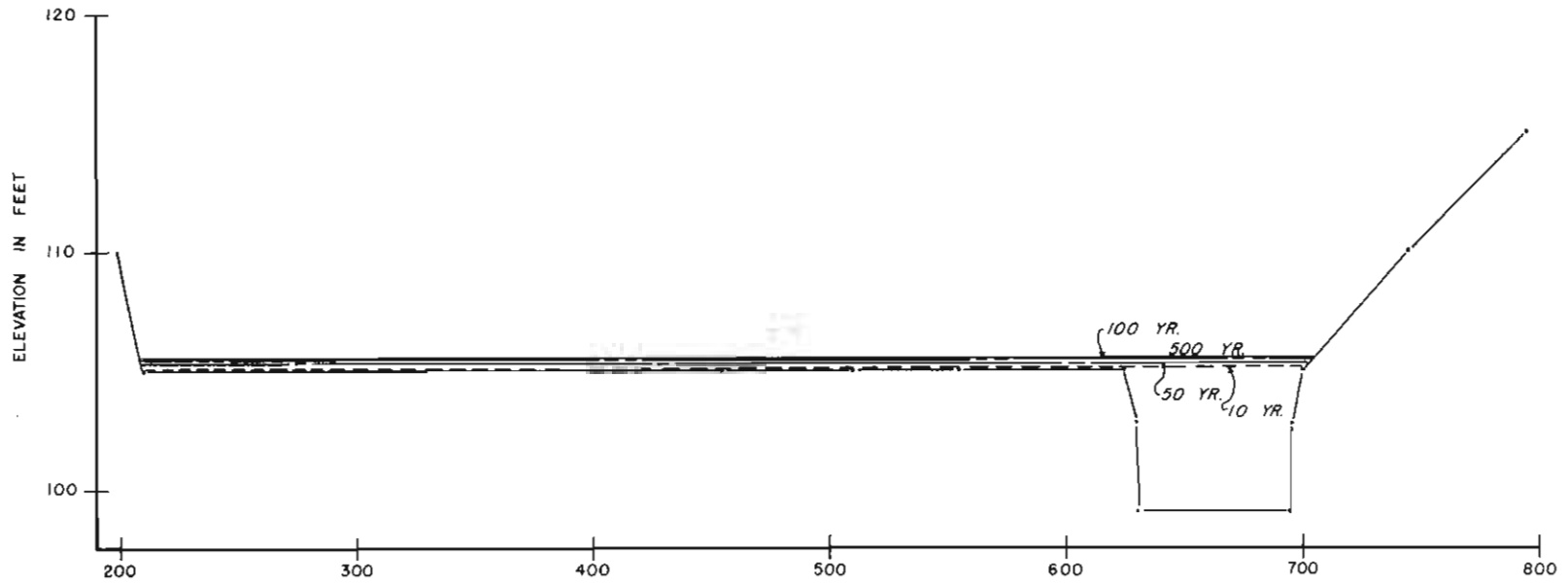

DISTANCE IN FEET
SECTION C-K
COTTONWOOD CREEK

SOIL CONSERVATION SERVICE
U.S. DEPARTMENT OF AGRICULTURE
TALKEETNA SUBBASIN
MATANUSKA-SUSITNA BOROUGH, ALASKA

FIGURE 36

TYPICAL VALLEY SECTION
PRESENT CONDITIONS

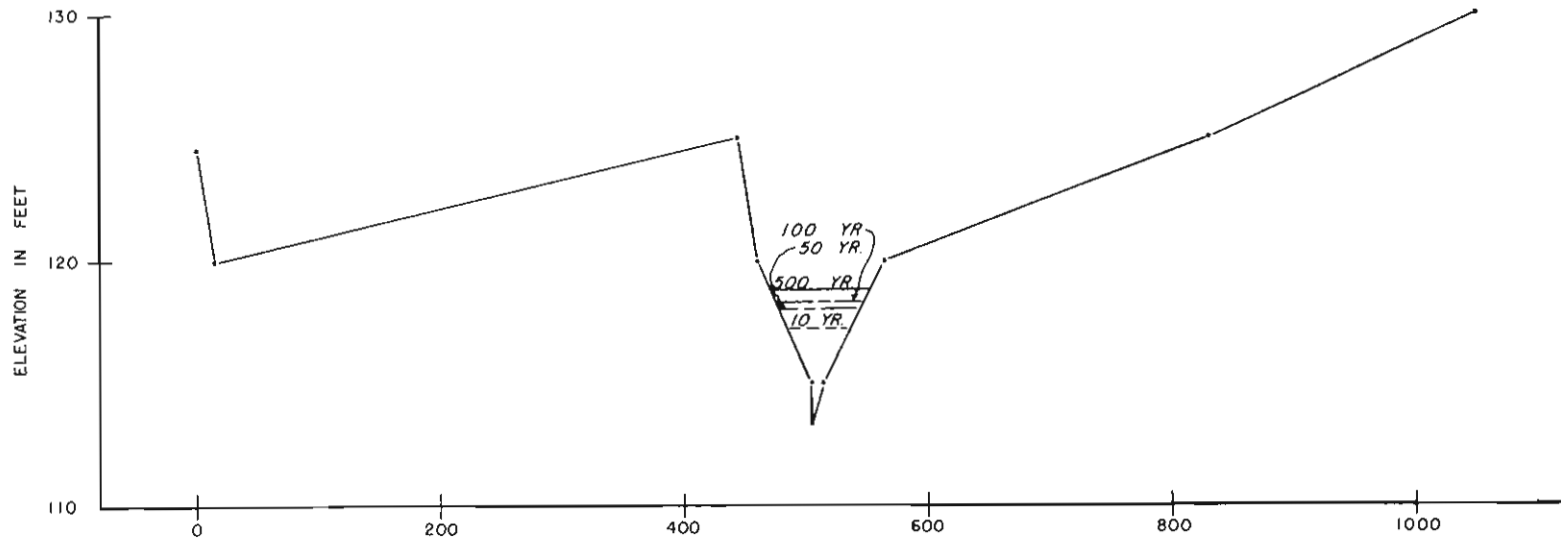

DISTANCE IN FEET
SECTION C-L
COTTONWOOD CREEK

SOIL CONSERVATION SERVICE
U.S. DEPARTMENT OF AGRICULTURE
TALKEETNA SUBBASIN
MATANUSKA-SUSITNA BOROUGH, ALASKA

FIGURE 37

TYPICAL VALLEY SECTION
PRESENT CONDITIONS

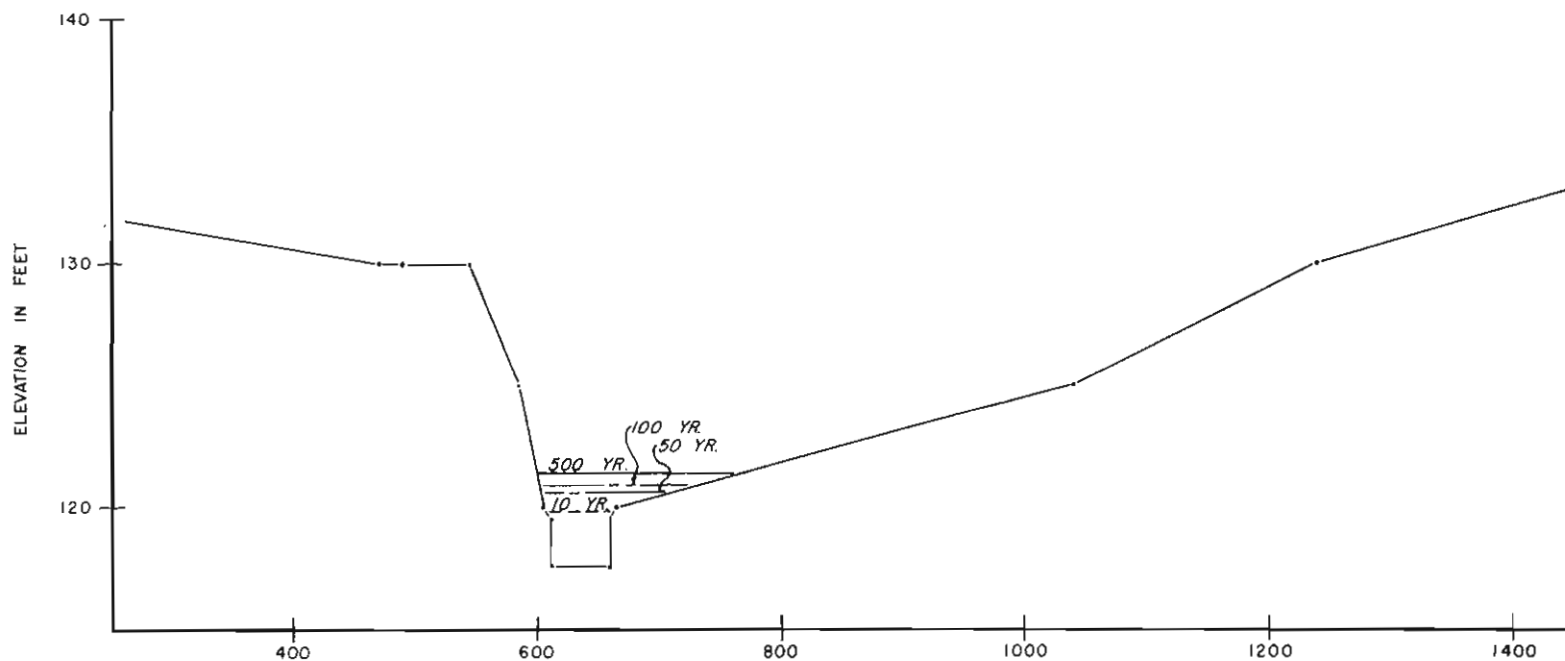

DISTANCE IN FEET
SECTION C-M
COTTONWOOD CREEK

SOIL CONSERVATION SERVICE
U. S. DEPARTMENT OF AGRICULTURE
TALKEETNA SUBBASIN
MATANUSKA - SUSITNA BOROUGH, ALASKA

FIGURE 38

TYPICAL VALLEY SECTION
PRESENT CONDITIONS

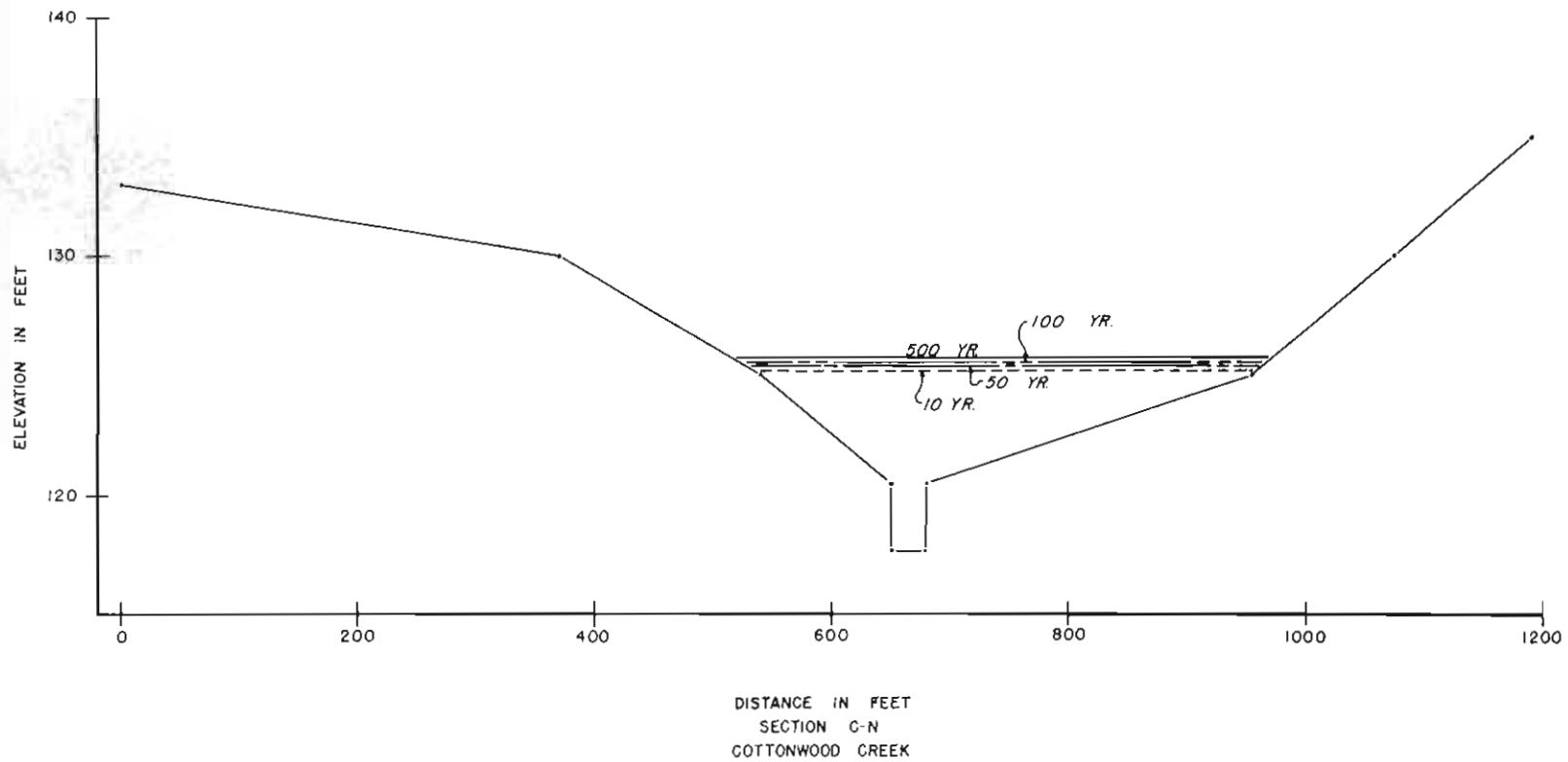

SOIL CONSERVATION SERVICE
U.S. DEPARTMENT OF AGRICULTURE
TALKEETNA SUBBASIN
MATANUSKA-SUSITNA BOROUGH, ALASKA

FIGURE 39

TYPICAL VALLEY SECTION
PRESENT CONDITIONS

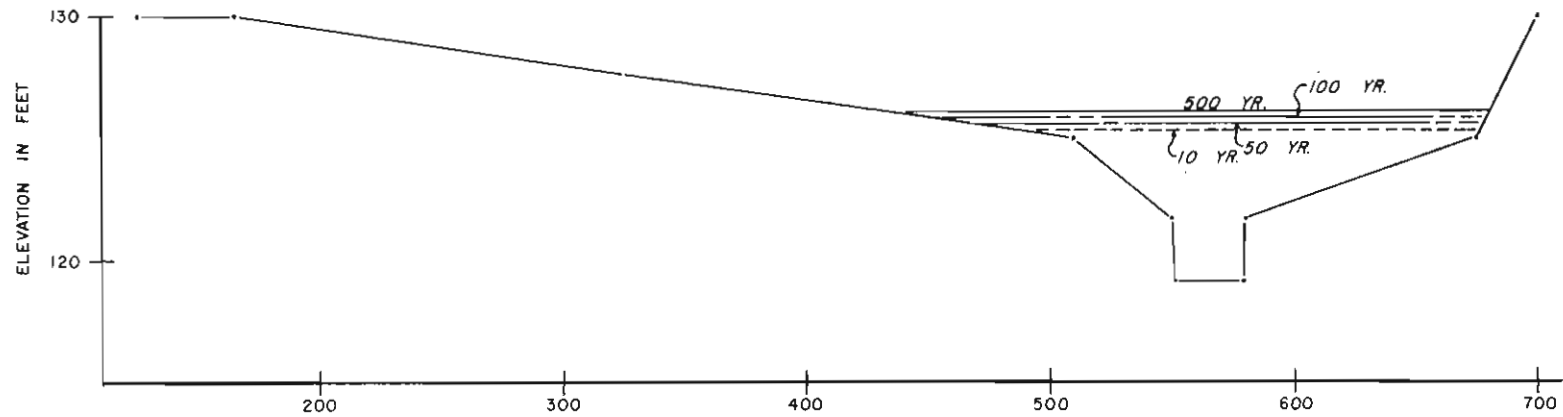

DISTANCE IN FEET
SECTION C-O
COTTONWOOD CREEK

SOIL CONSERVATION SERVICE
U. S. DEPARTMENT OF AGRICULTURE
TALKEETNA SUBBASIN
MATANUSKA - SUSITNA BOROUGH, ALASKA

FIGURE 40

TYPICAL VALLEY SECTION
PRESENT CONDITIONS

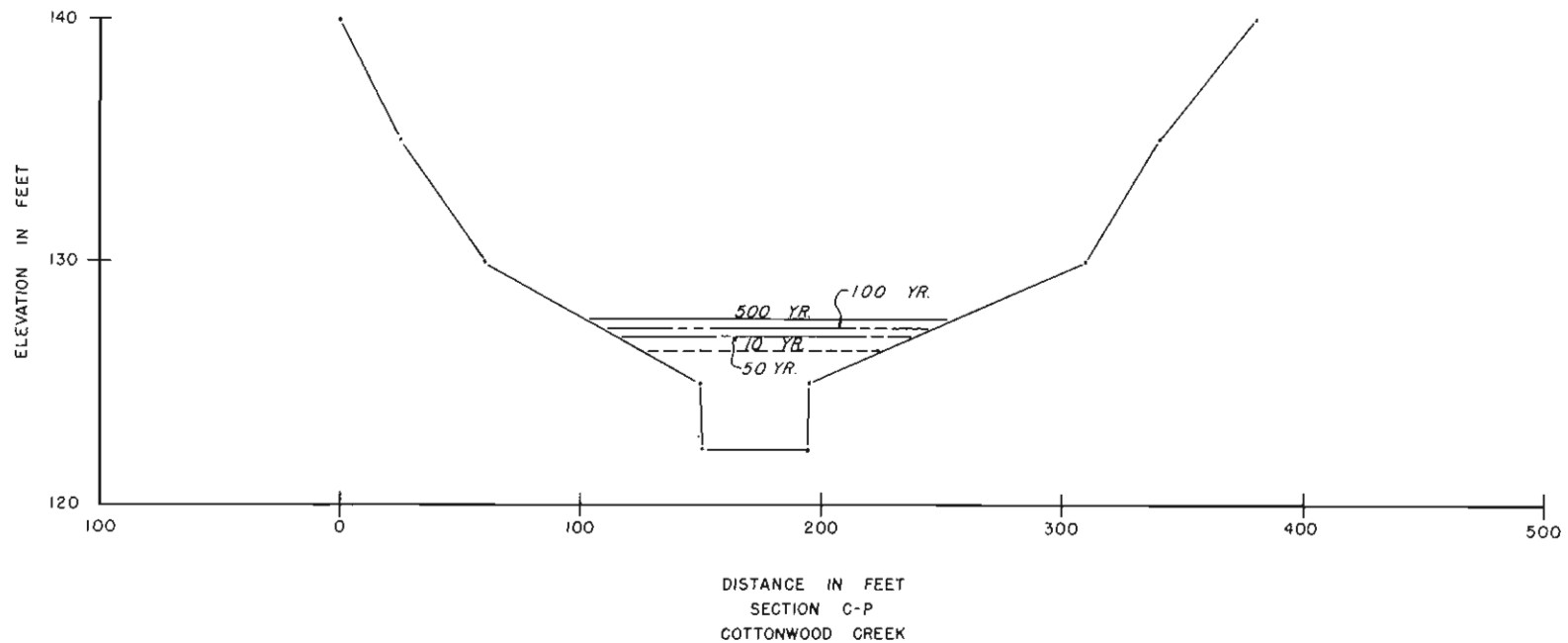

SOIL CONSERVATION SERVICE
U. S. DEPARTMENT OF AGRICULTURE
TALKEETNA SUBBASIN
MATANUSKA-SUSITNA BOROUGH, ALASKA

FIGURE 41

TYPICAL VALLEY SECTION
PRESENT CONDITIONS

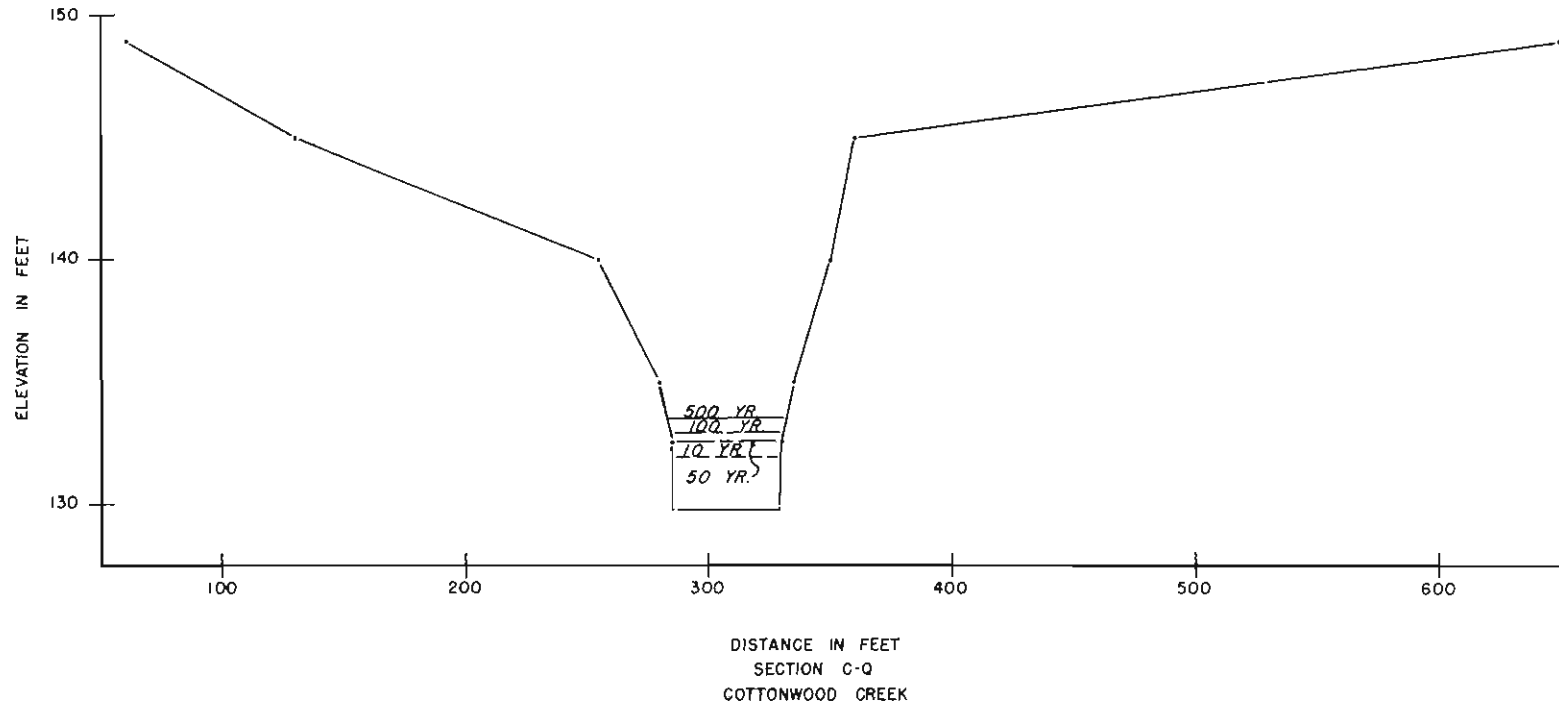

SOIL CONSERVATION SERVICE
U.S. DEPARTMENT OF AGRICULTURE
TALKEETNA SUBBASIN
MATANUSKA-SUSITNA BOROUGH, ALASKA

FIGURE 42

TYPICAL VALLEY SECTION
PRESENT CONDITIONS

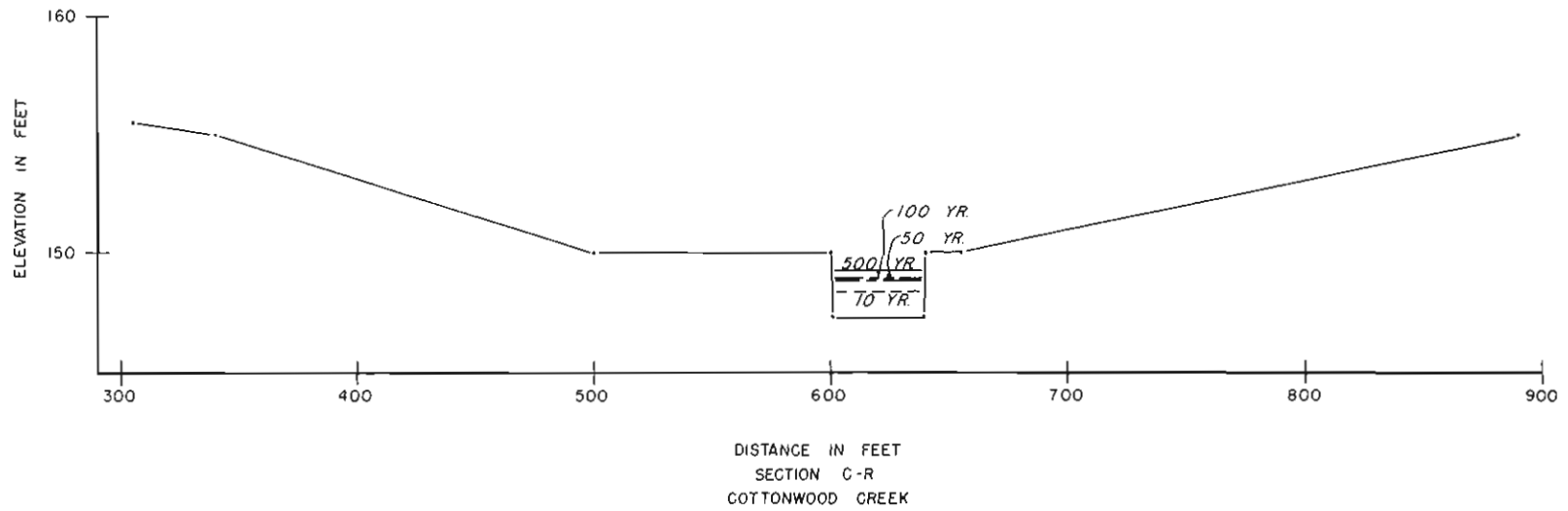

SOIL CONSERVATION SERVICE
U.S. DEPARTMENT OF AGRICULTURE
TALKEETNA SUBBASIN
MATANUSKA - SUSITNA BOROUGH, ALASKA

FIGURE 43

TYPICAL VALLEY SECTION
PRESENT CONDITIONS

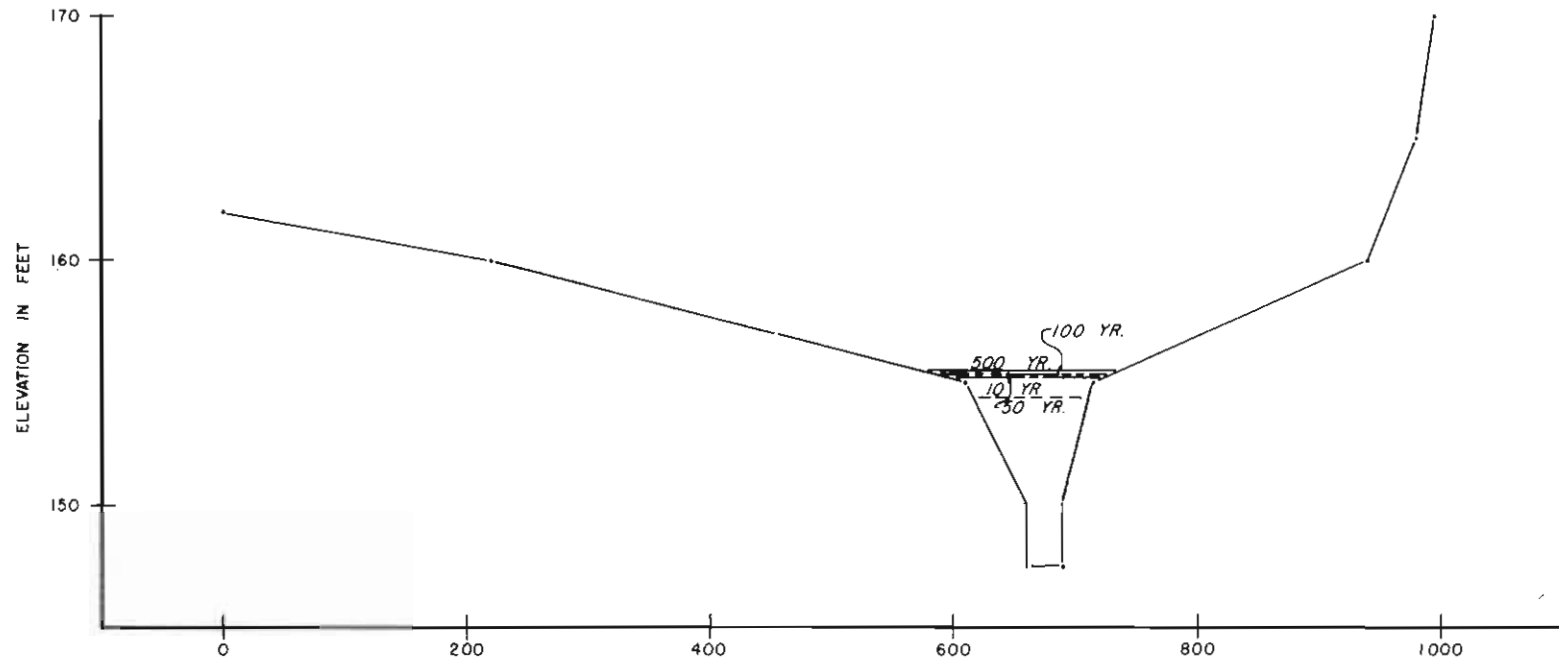

DISTANCE IN FEET
SECTION C-T
COTTONWOOD CREEK

SOIL CONSERVATION SERVICE
U.S. DEPARTMENT OF AGRICULTURE
TALKEETNA SUBBASIN
MATANUSKA-SUSITNA BOROUGH, ALASKA

FIGURE 44

TYPICAL VALLEY SECTION
PRESENT CONDITIONS

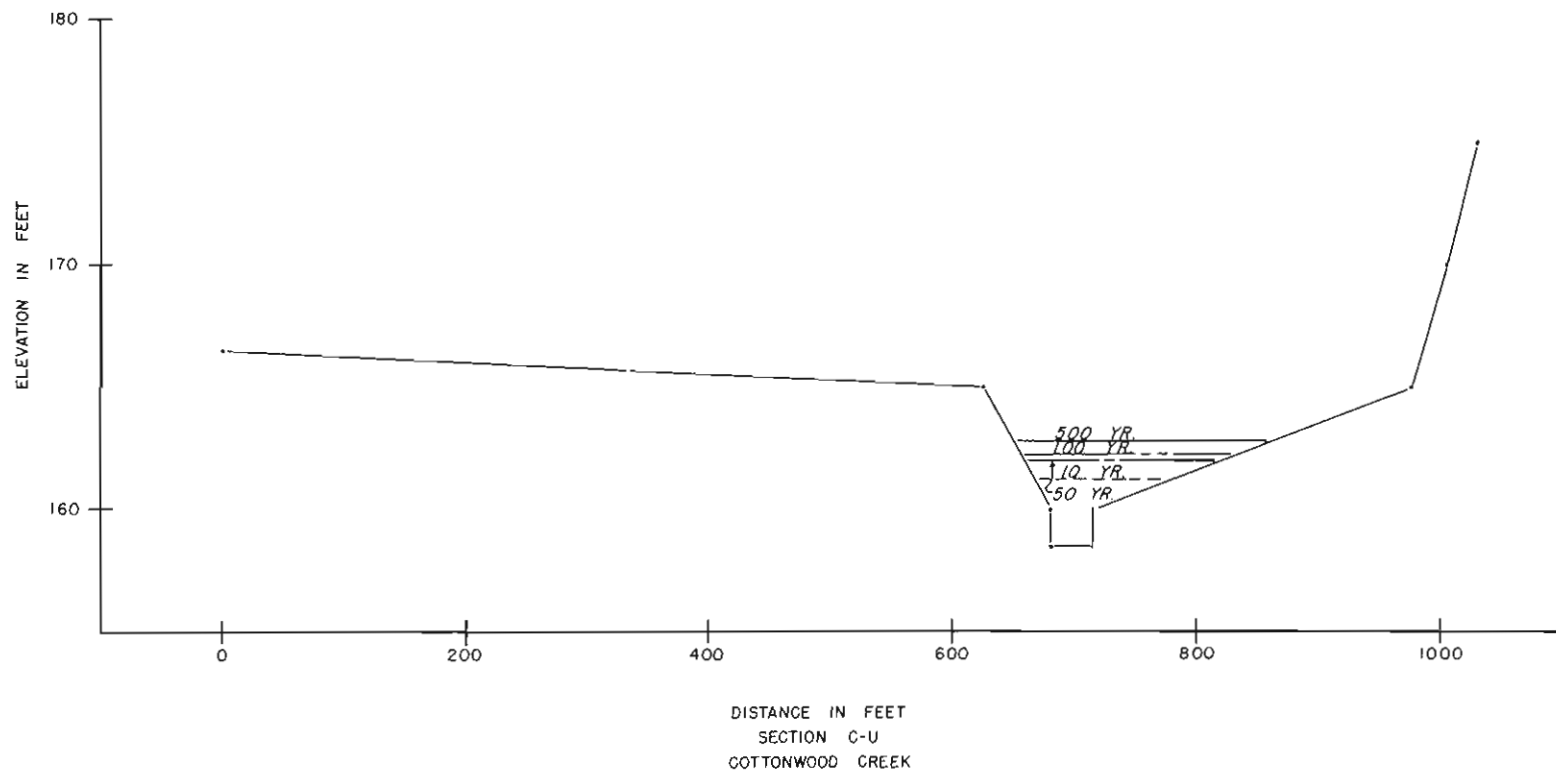

SOIL CONSERVATION SERVICE
U.S. DEPARTMENT OF AGRICULTURE
TALKEETNA SUBBASIN
MATANUSKA-SUSITNA BOROUGH, ALASKA

FIGURE 45

TYPICAL VALLEY SECTION
PRESENT CONDITIONS

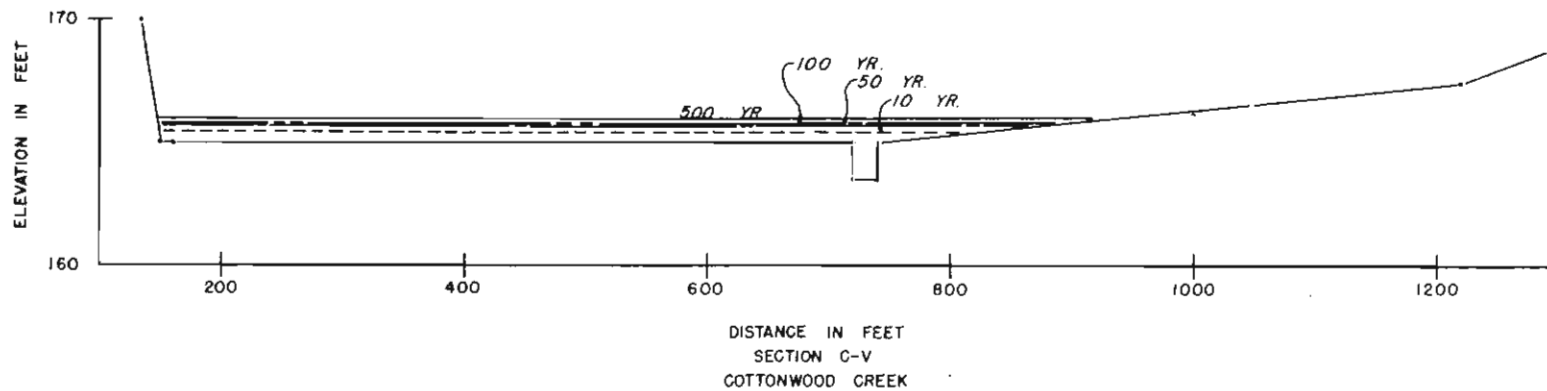

SOIL CONSERVATION SERVICE
U.S. DEPARTMENT OF AGRICULTURE
TALKEETNA SUBBASHN
MATANUSKA-SUSITNA BOROUGH, ALASKA

FIGURE 46

TYPICAL VALLEY SECTION
PRESENT CONDITIONS

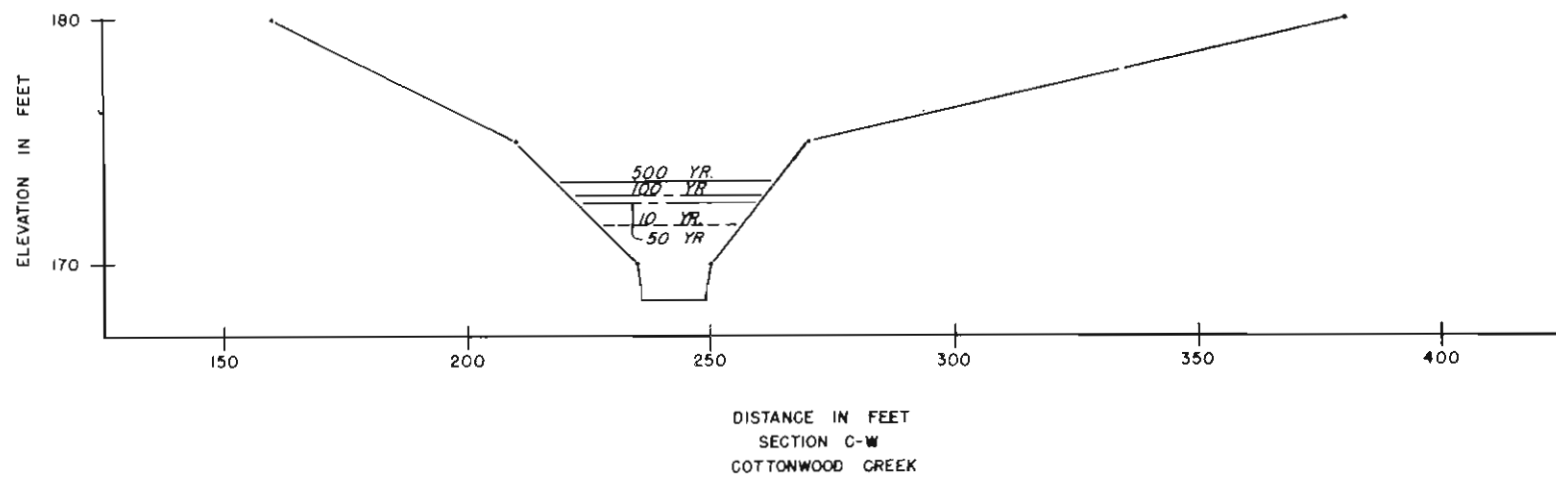

SOIL CONSERVATION SERVICE
U.S. DEPARTMENT OF AGRICULTURE
TALKEETNA SUBBASIN
MATANUSKA-SUSITNA BOROUGH, ALASKA

FIGURE 47

TYPICAL VALLEY SECTION
PRESENT CONDITIONS

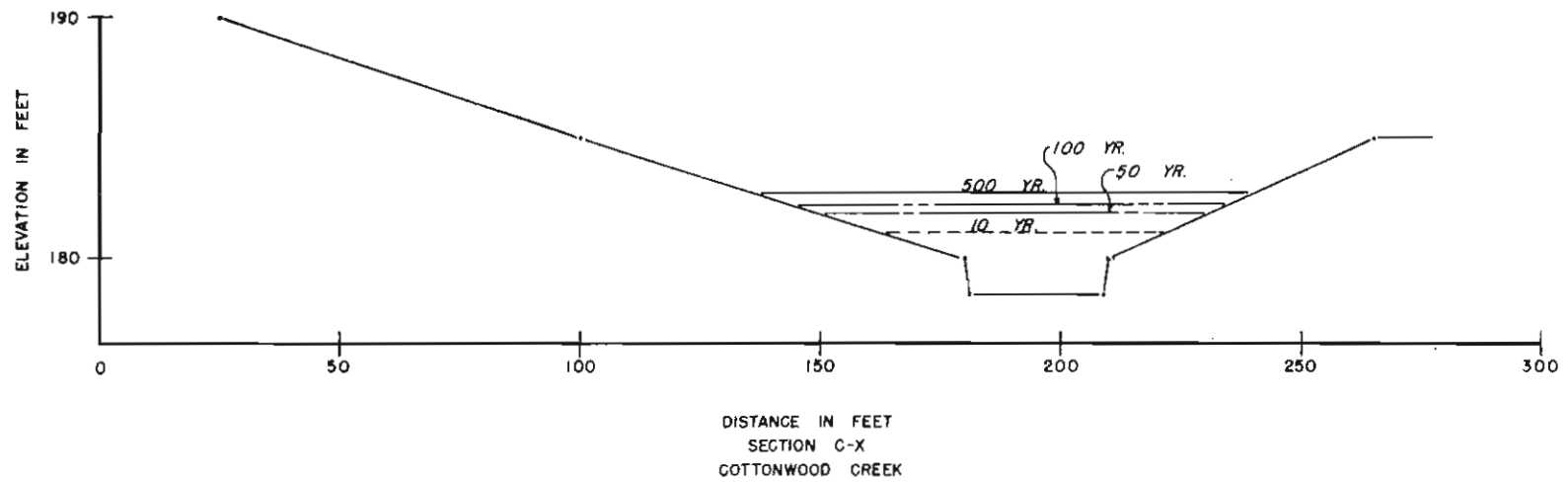

SOIL CONSERVATION SERVICE
U.S. DEPARTMENT OF AGRICULTURE
TALKEETNA SUBBASIN
MATANUSKA-SUSITNA BOROUGH, ALASKA

FIGURE 46

TYPICAL VALLEY SECTION
PRESENT CONDITIONS

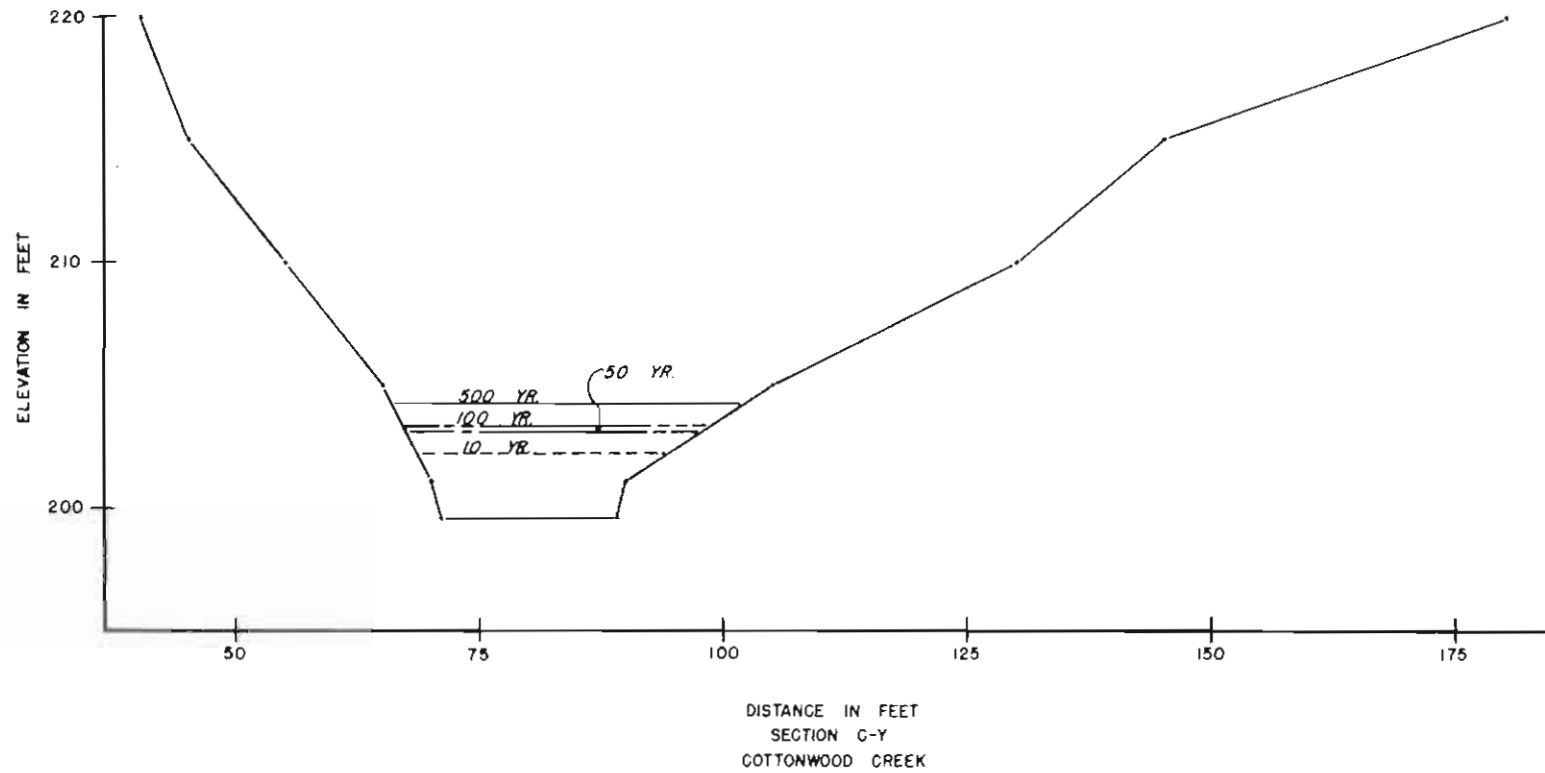

SOIL CONSERVATION SERVICE
U. S. DEPARTMENT OF AGRICULTURE
TALKEETNA SUBBASIN
MATANUSKA-SUSITNA BOROUGH, ALASKA

FIGURE 49

TYPICAL VALLEY SECTION
PRESENT CONDITIONS

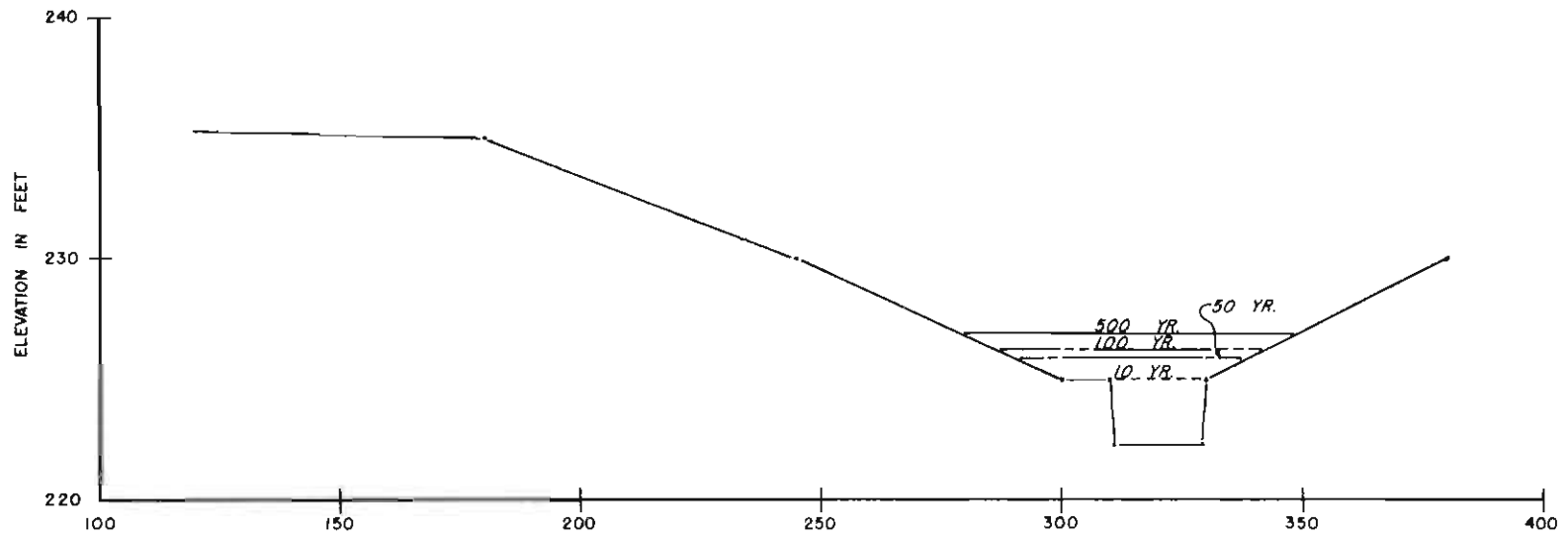

DISTANCE IN FEET
SECTION C-Z
COTTONWOOD CREEK

SOIL CONSERVATION SERVICE
U. S. DEPARTMENT OF AGRICULTURE
TALKEETNA SUBBASIN
MATANUSKA-SUSITNA BOROUGH, ALASKA

FIGURE 50

TYPICAL VALLEY SECTION
PRESENT CONDITIONS

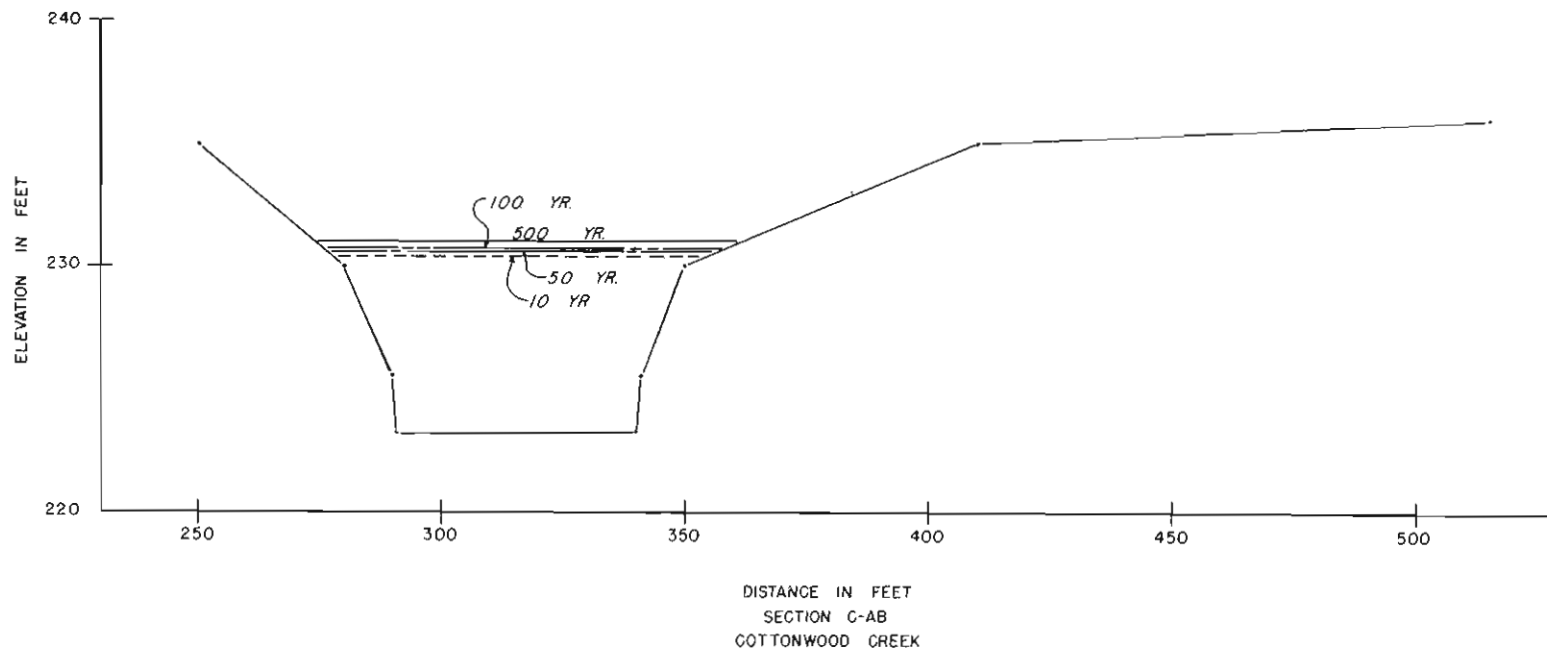

SOIL CONSERVATION SERVICE
U.S. DEPARTMENT OF AGRICULTURE
TALKEETNA SUBBASIN
MATANUSKA-SUSITNA BOROUGH, ALASKA

FIGURE 5J

TYPICAL VALLEY SECTION
PRESENT CONDITIONS

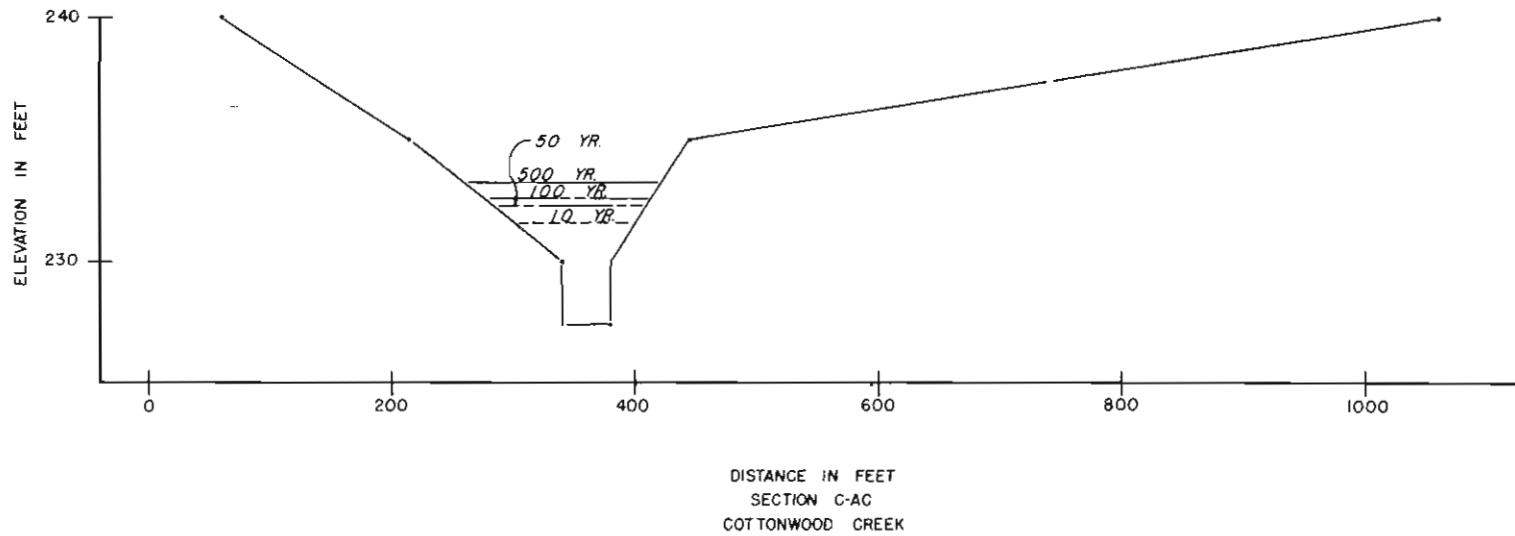

SOIL CONSERVATION SERVICE
U.S. DEPARTMENT OF AGRICULTURE
TALKEETNA SUBBASIN
MATANUSKA-SUSITNA BOROUGH, ALASKA

FIGURE 52

TYPICAL VALLEY SECTION
PRESENT CONDITIONS

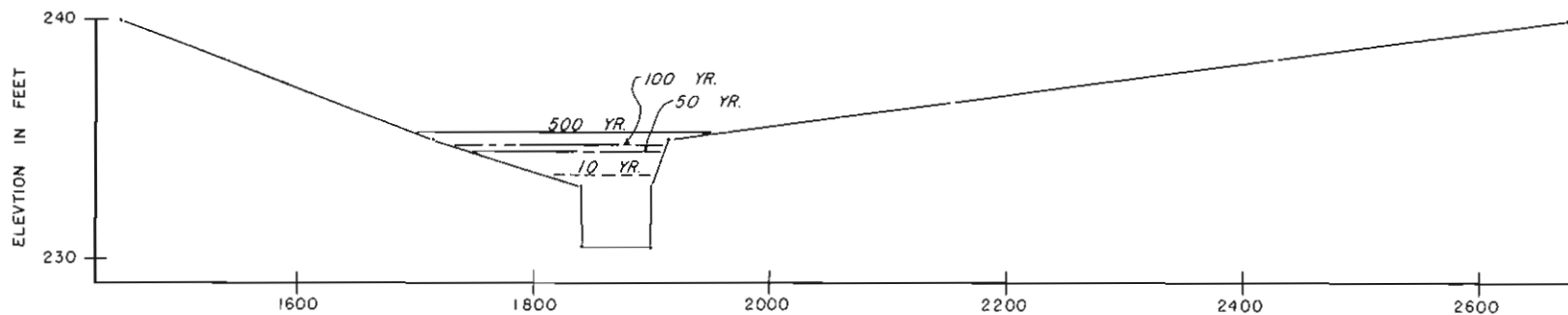

DISTANCE IN FEET
SECTION C-AD
COTTONWOOD CREEK

SOIL CONSERVATION SERVICE
U.S. DEPARTMENT OF AGRICULTURE
TALKEETNA SUBBASIN
MATANUSKA-SUSITNA BOROUGH, ALASKA

FIGURE 53

TYPICAL VALLEY SECTION
PRESENT CONDITIONS

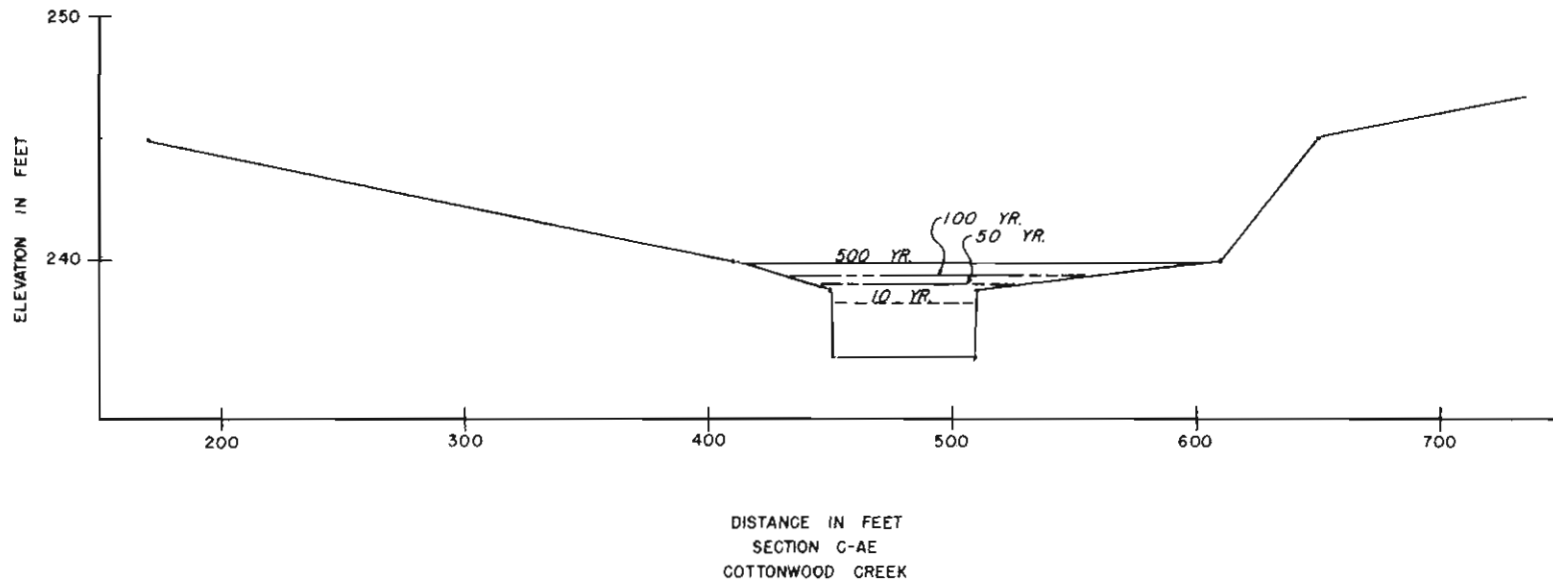

SOIL CONSERVATION SERVICE
U.S. DEPARTMENT OF AGRICULTURE
TALKEETNA SUBBASIN
MATANUSKA-SUSITNA BOROUGH, ALASKA

FIGURE 54

TYPICAL VALLEY SECTION
PRESENT CONDITIONS

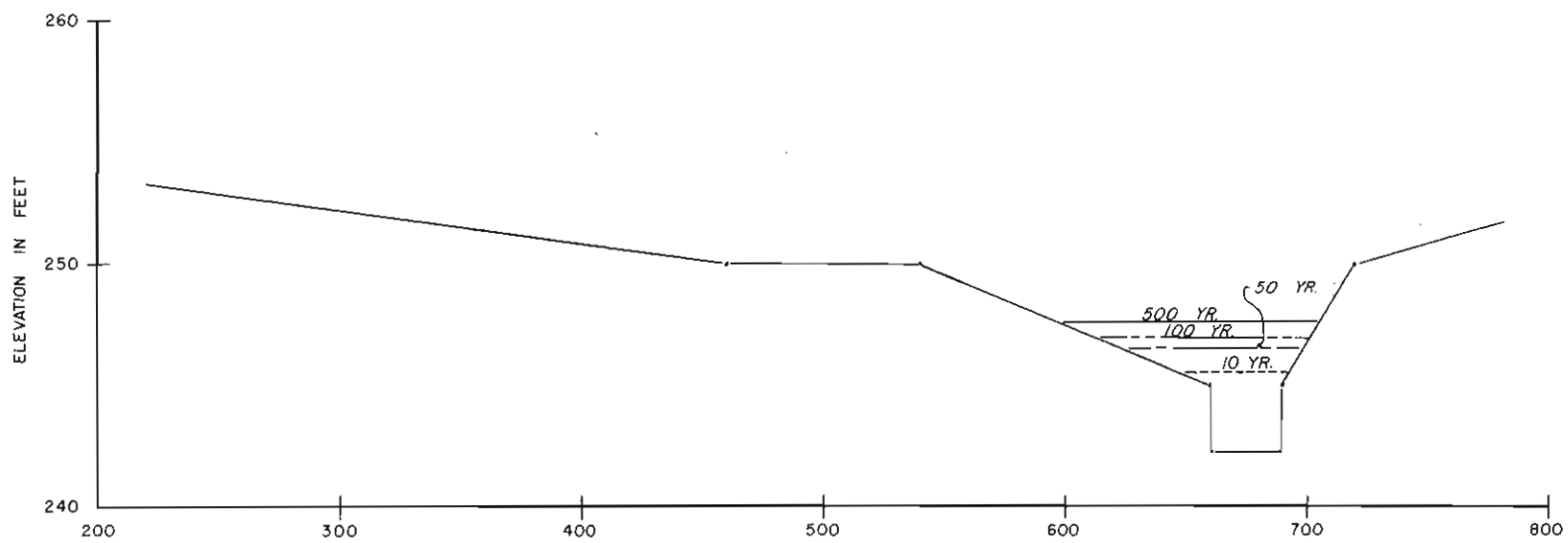

SECTION C-AF
COTTONWOOD CREEK

SOIL CONSERVATION SERVICE
U. S. DEPARTMENT OF AGRICULTURE
TALKEETNA SUBBASIN
MATANUSKA-SUSITNA BOROUGH, ALASKA

FIGURE 55

TYPICAL VALLEY SECTION
PRESENT CONDITIONS

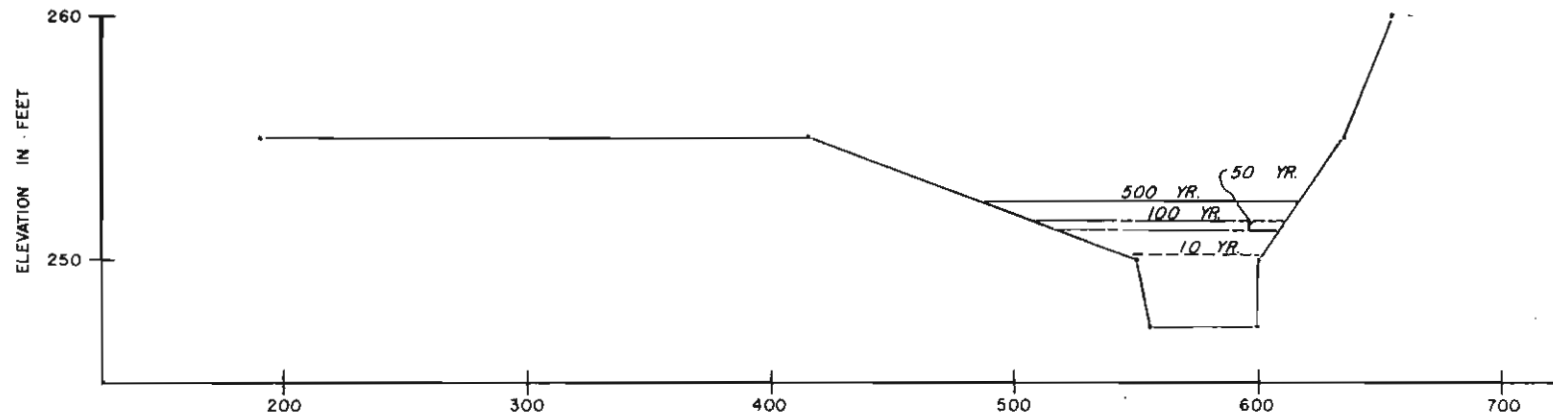

DISTANCE IN FEET
SECTION C-AG
COTTONWOOD CREEK

SOIL CONSERVATION SERVICE
U.S. DEPARTMENT OF AGRICULTURE
TALKEETNA SUBBASIN
MATANUSKA-SUSITNA BOROUGH, ALASKA

FIGURE 56

TYPICAL VALLEY SECTION
PRESENT CONDITIONS

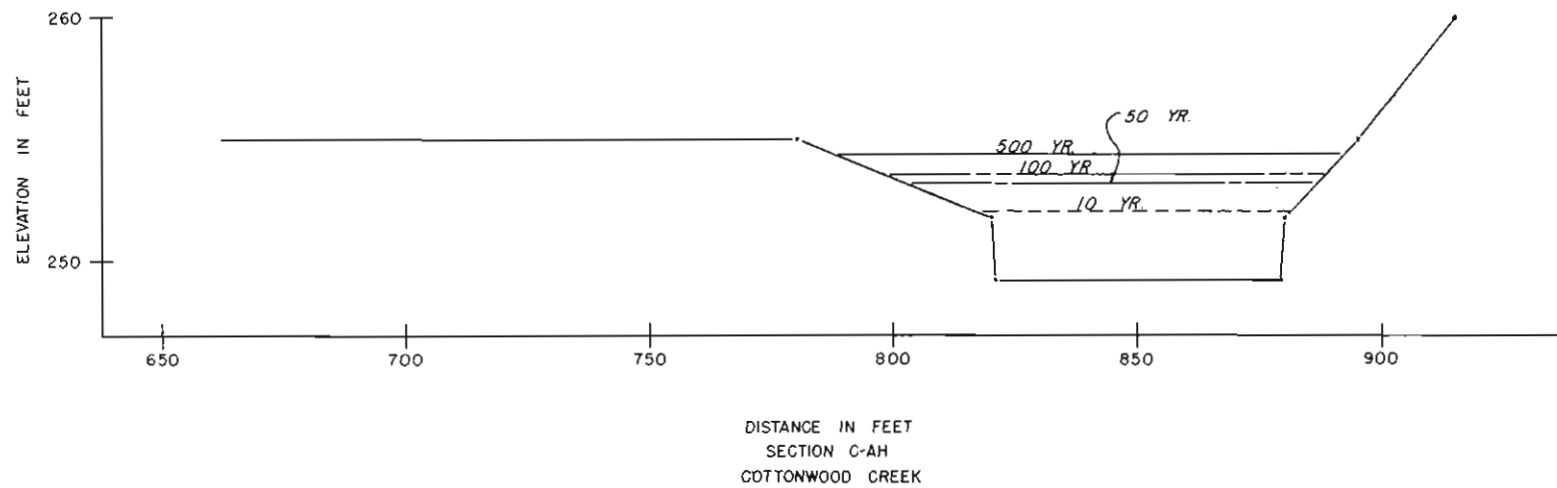

DISTANCE IN FEET
SECTION C-AH
COTTONWOOD CREEK

SOIL CONSERVATION SERVICE
U.S. DEPARTMENT OF AGRICULTURE
TALKEETNA SUBBASIN
MATANUSKA - SUSITNA BOROUGH, ALASKA

FIGURE 57

TYPICAL VALLEY SECTION
PRESENT CONDITIONS

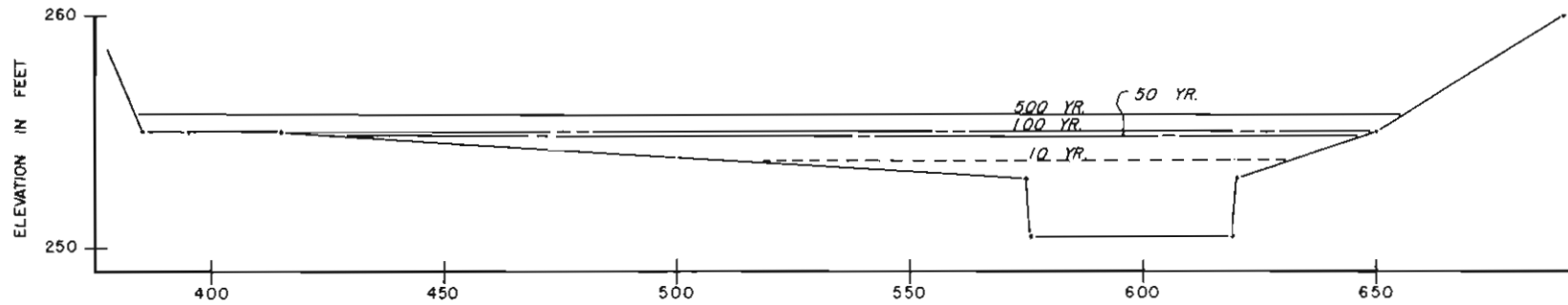

DISTANCE IN FEET
SECTION C-A1
COTTONWOOD CREEK

SOIL CONSERVATION SERVICE
U.S. DEPARTMENT OF AGRICULTURE
TALKEETNA SUBBASIN
MATANUSKA-SUSITNA BOROUGH, ALASKA

FIGURE 58

TYPICAL VALLEY SECTION
PRESENT CONDITIONS

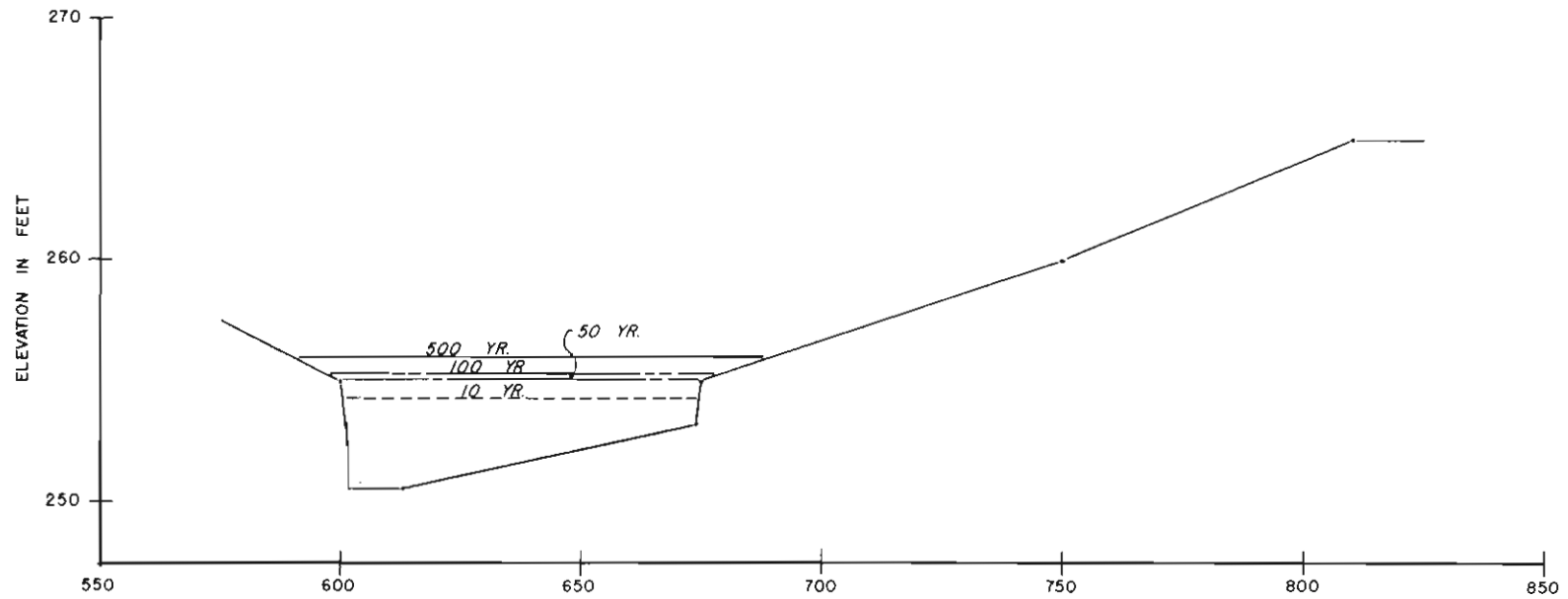

DISTANCE IN FEET
SECTION C-AK
COTTONWOOD CREEK

SOIL CONSERVATION SERVICE
U.S. DEPARTMENT OF AGRICULTURE
TALKEETNA SUBBASIN
MATANUSKA-SUSITNA BOROUGH, ALASKA

FIGURE 59

TYPICAL VALLEY SECTION
PRESENT CONDITIONS

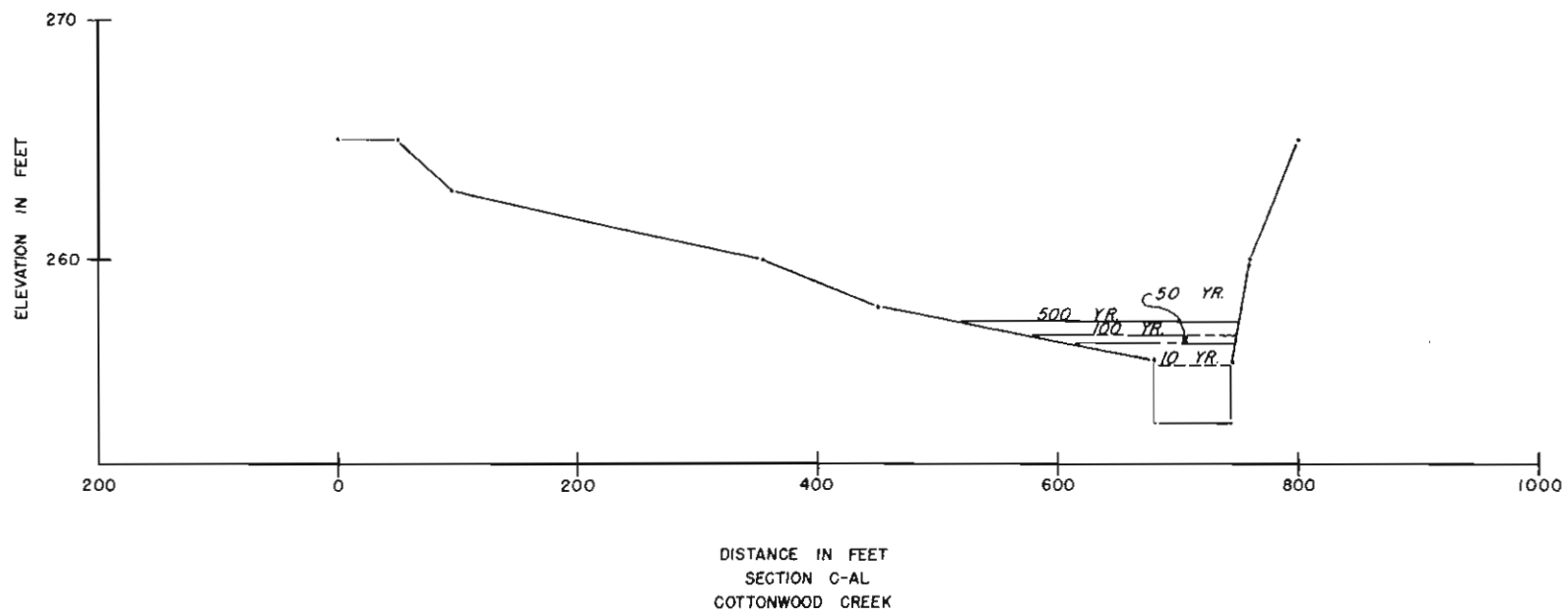

SOIL CONSERVATION SERVICE
U.S. DEPARTMENT OF AGRICULTURE
TALKEETNA SUBBASIN
MATANUSKA - SUSITNA BOROUGH, ALASKA

FIGURE 60

TYPICAL VALLEY SECTION
PRESENT CONDITIONS

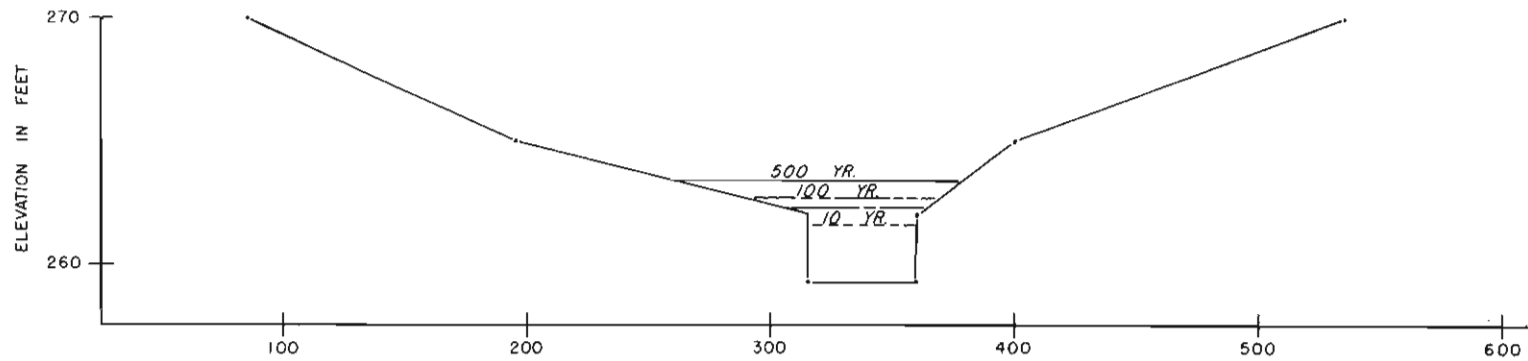

DISTANCE IN FEET
SECTION C-AM
COTTONWOOD CREEK

SOIL CONSERVATION SERVICE
U.S. DEPARTMENT OF AGRICULTURE
TALKEETNA SUBBASIN
MATANUSKA-SUSITNA BOROUGH, ALASKA

FIGURE 61

TYPICAL VALLEY SECTION
PRESENT CONDITIONS

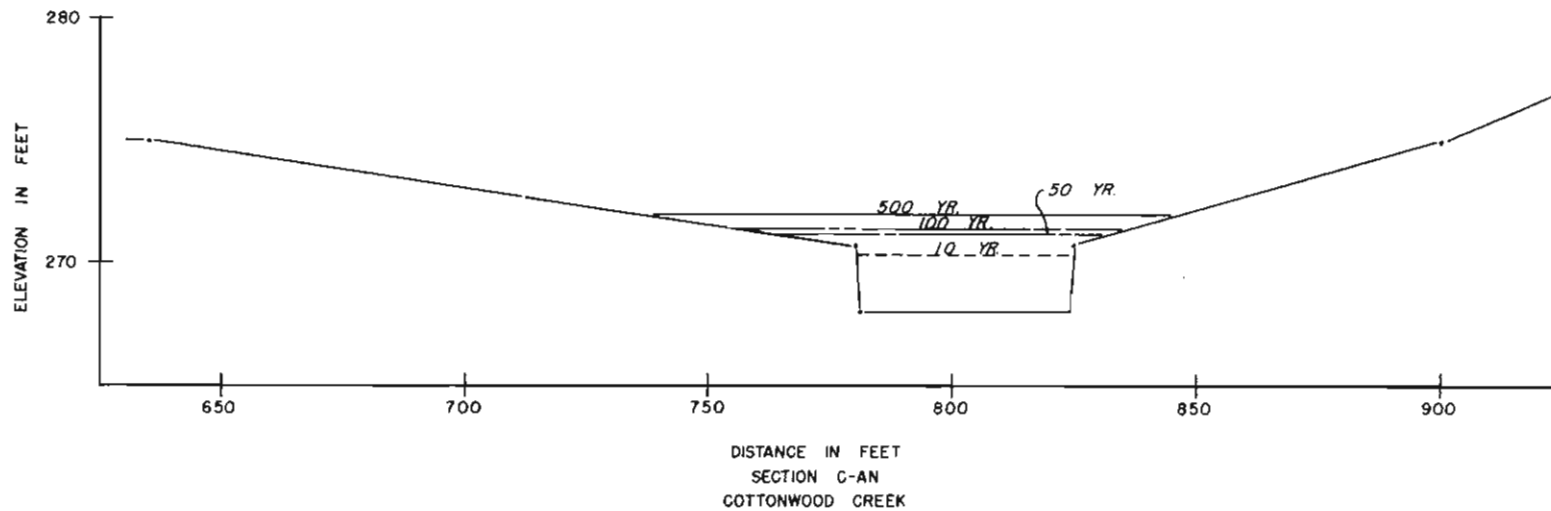

SOIL CONSERVATION SERVICE
U.S. DEPARTMENT OF AGRICULTURE
TALKEETNA SUBBASIN
MATANUSKA-SUSITNA BOROUGH, ALASKA

FIGURE 62

TYPICAL VALLEY SECTION
PRESENT CONDITIONS

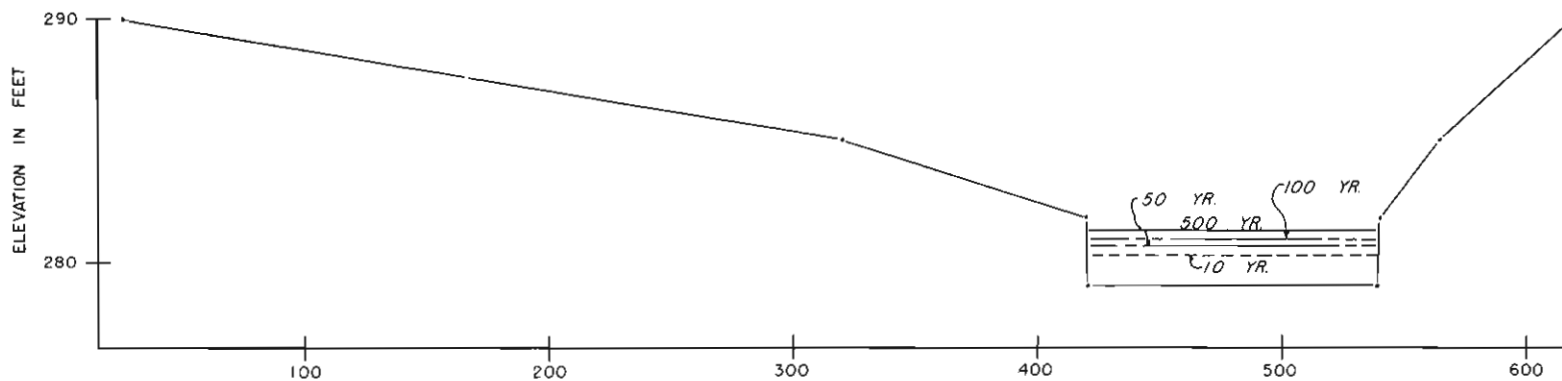

DISTANCE IN FEET
SECTION C-AO
COTTONWOOD CREEK

SOIL CONSERVATION SERVICE
U.S. DEPARTMENT OF AGRICULTURE
TALKEETNA SUBBASIN
MATANUSKA - SUSITNA BOROUGH, ALASKA

FIGURE 63

TYPICAL VALLEY SECTION
PRESENT CONDITIONS

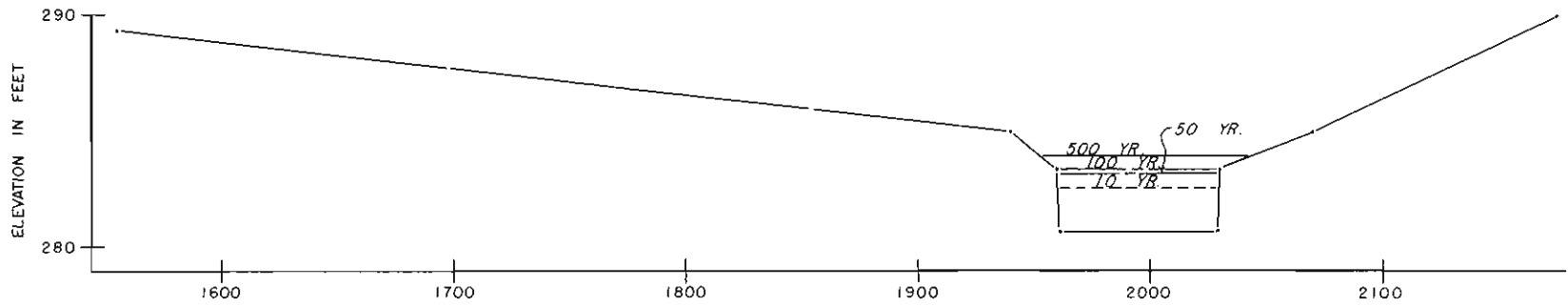

DISTANCE IN FEET
SECTION C-AP
COTTONWOOD CREEK

SOIL CONSERVATION SERVICE
U.S. DEPARTMENT OF AGRICULTURE
TALKEETNA SUBBASIN
MATAUSKA-SUSITNA BOROUGH, ALASKA

FIGURE 64

TYPICAL VALLEY SECTION
PRESENT CONDITIONS

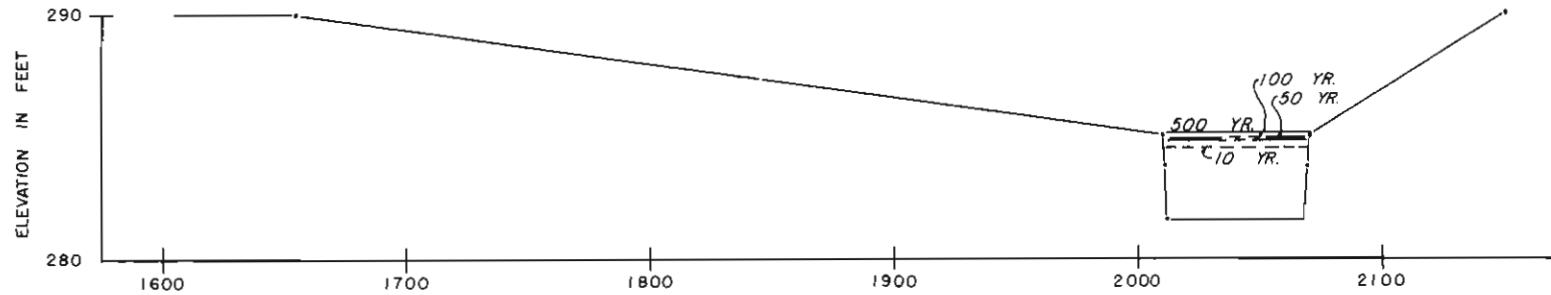

DISTANCE IN FEET
SECTION C-AR
COTTONWOOD CREEK

SOIL CONSERVATION SERVICE
U.S. DEPARTMENT OF AGRICULTURE
TALKEETNA SUBBASIN
MATANUSKA - SUSITNA BOROUGH, ALASKA

FIGURE 65

TYPICAL VALLEY SECTION
PRESENT CONDITIONS

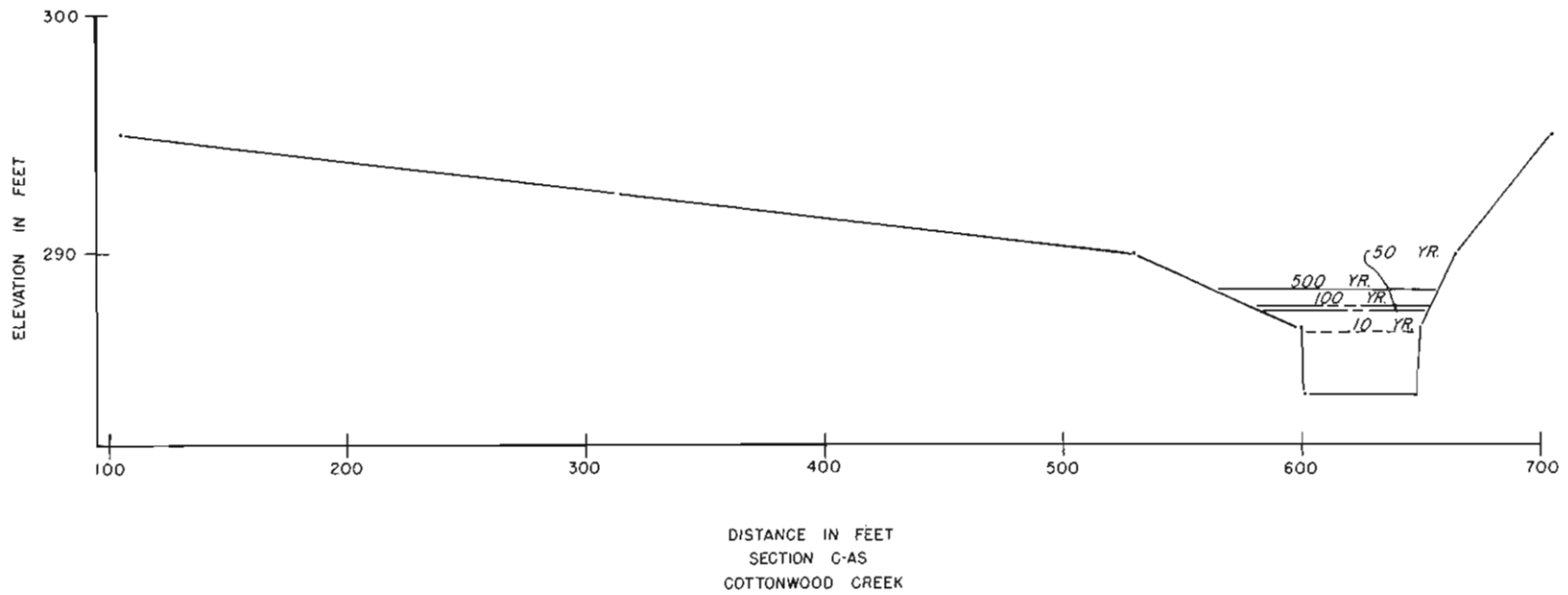

SOIL CONSERVATION SERVICE
U.S. DEPARTMENT OF AGRICULTURE
TALKEETNA SUBBASIN
MATANUSKA - SUSITNA BOROUGH, ALASKA

FIGURE 66

TYPICAL VALLEY SECTION
PRESENT CONDITIONS

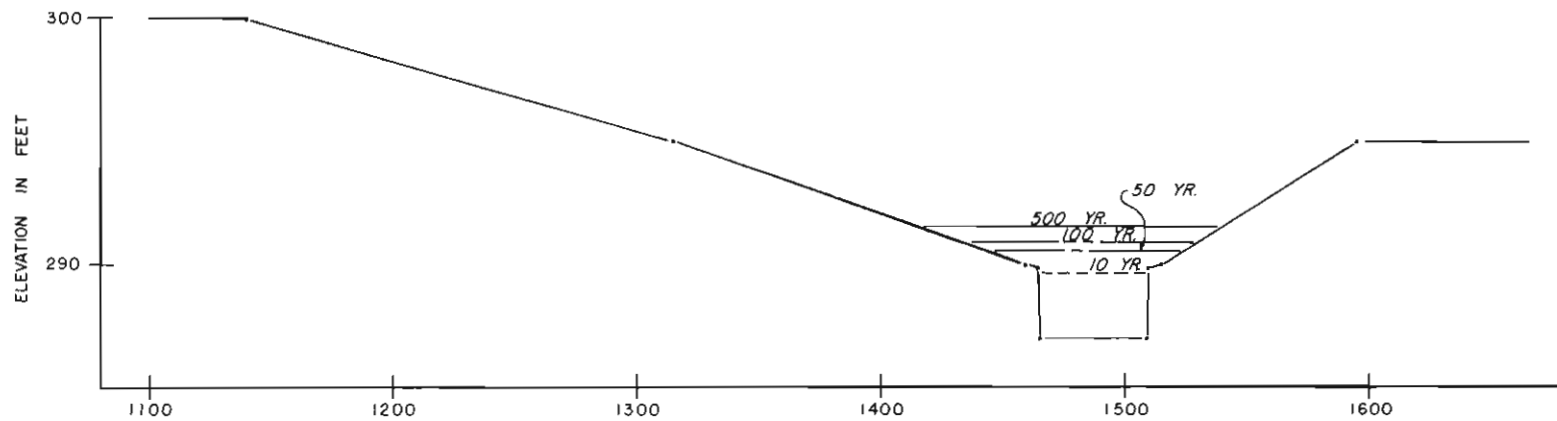

DISTANCE IN FEET
SECTION C-AT
COTTONWOOD CREEK

SOIL CONSERVATION SERVICE
U.S. DEPARTMENT OF AGRICULTURE
TALKEETNA SUBBASIN
MATANUSKA-SUSITNA BOROUGH, ALASKA

FIGURE 67

TYPICAL VALLEY SECTION
PRESENT CONDITIONS

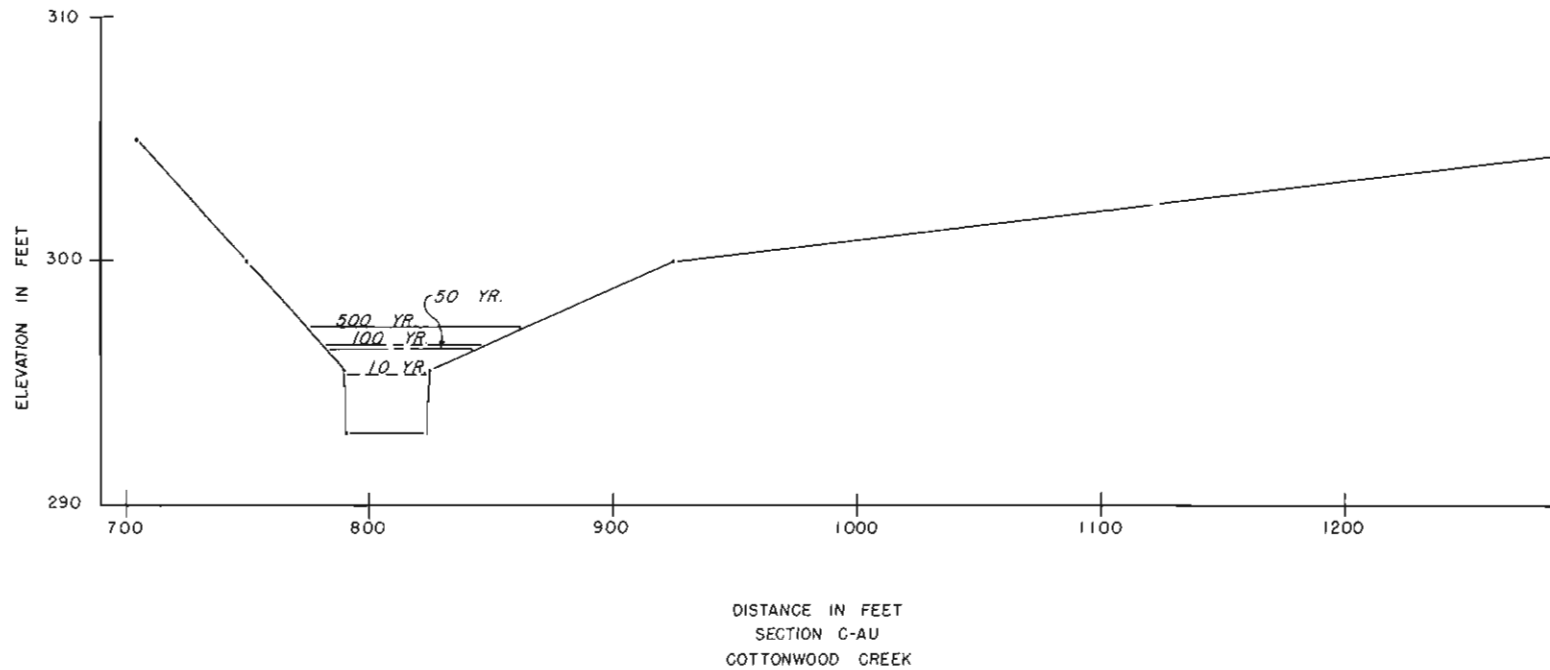

SOIL CONSERVATION SERVICE
U.S. DEPARTMENT OF AGRICULTURE
TALKEETNA SUBBASIN
MATANUSKA-SUSITNA BOROUGH, ALASKA

FIGURE 68

TYPICAL VALLEY SECTION
PRESENT CONDITIONS

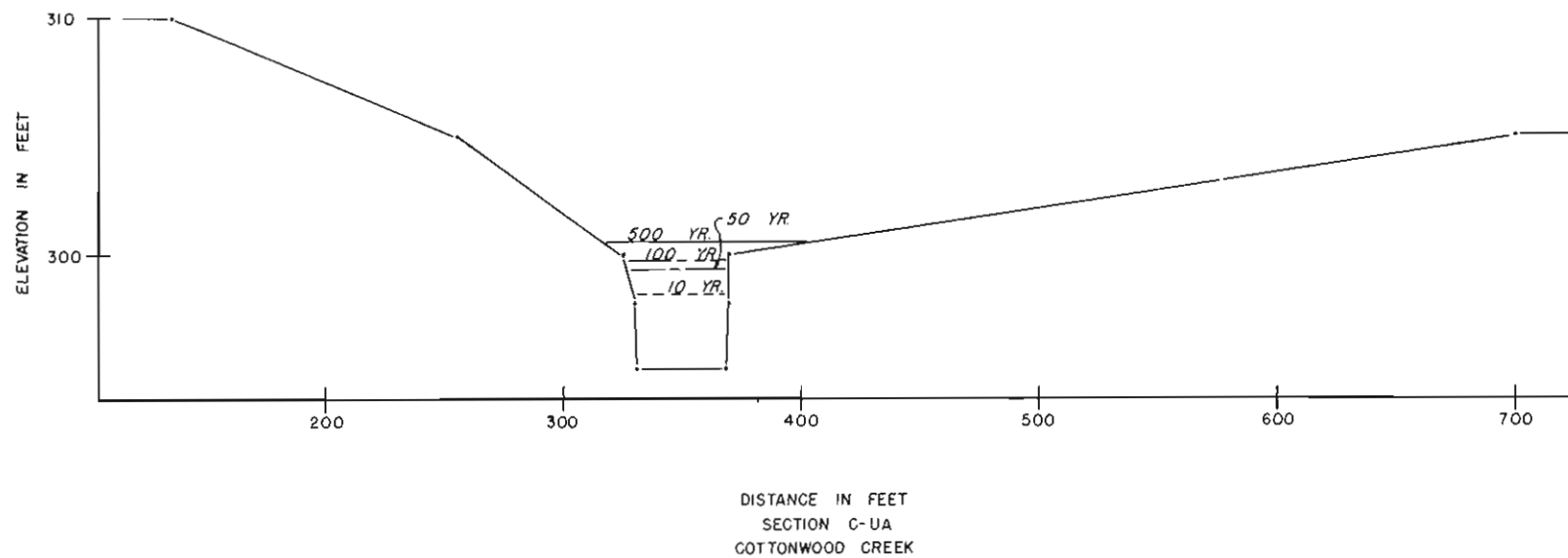

SOIL CONSERVATION SERVICE
U.S. DEPARTMENT OF AGRICULTURE
TALKEETNA SUBBASIN
MATANUSKA-SUSITNA BOROUGH, ALASKA

FIGURE 69

TYPICAL VALLEY SECTION
PRESENT CONDITIONS

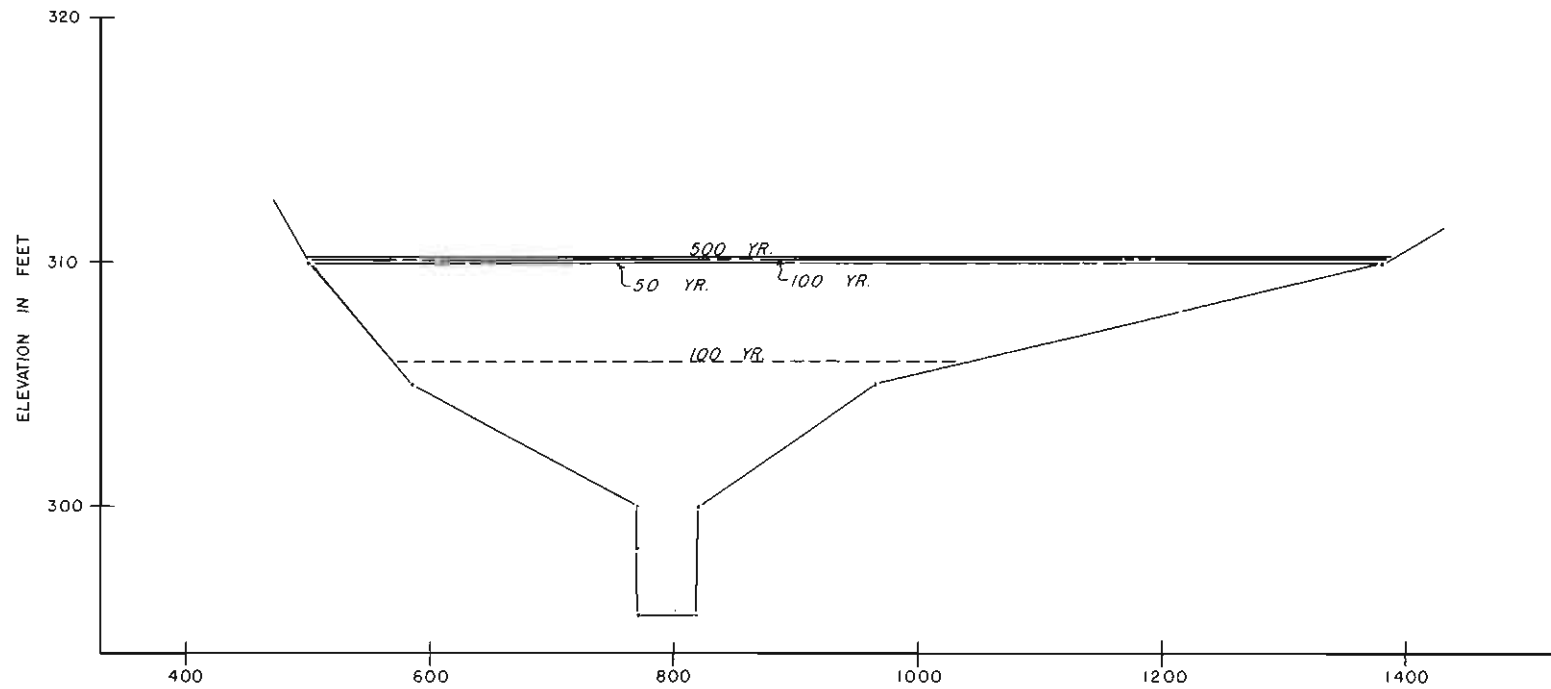

DISTANCE IN FEET
SECTION C-AW
COTTONWOOD CREEK

SOIL CONSERVATION SERVICE
U.S. DEPARTMENT OF AGRICULTURE
TALKEETNA SUBBASIN
MATANUSKA-SUSITNA BOROUGH, ALASKA

FIGURE 70

TYPICAL VALLEY SECTION
PRESENT CONDITIONS

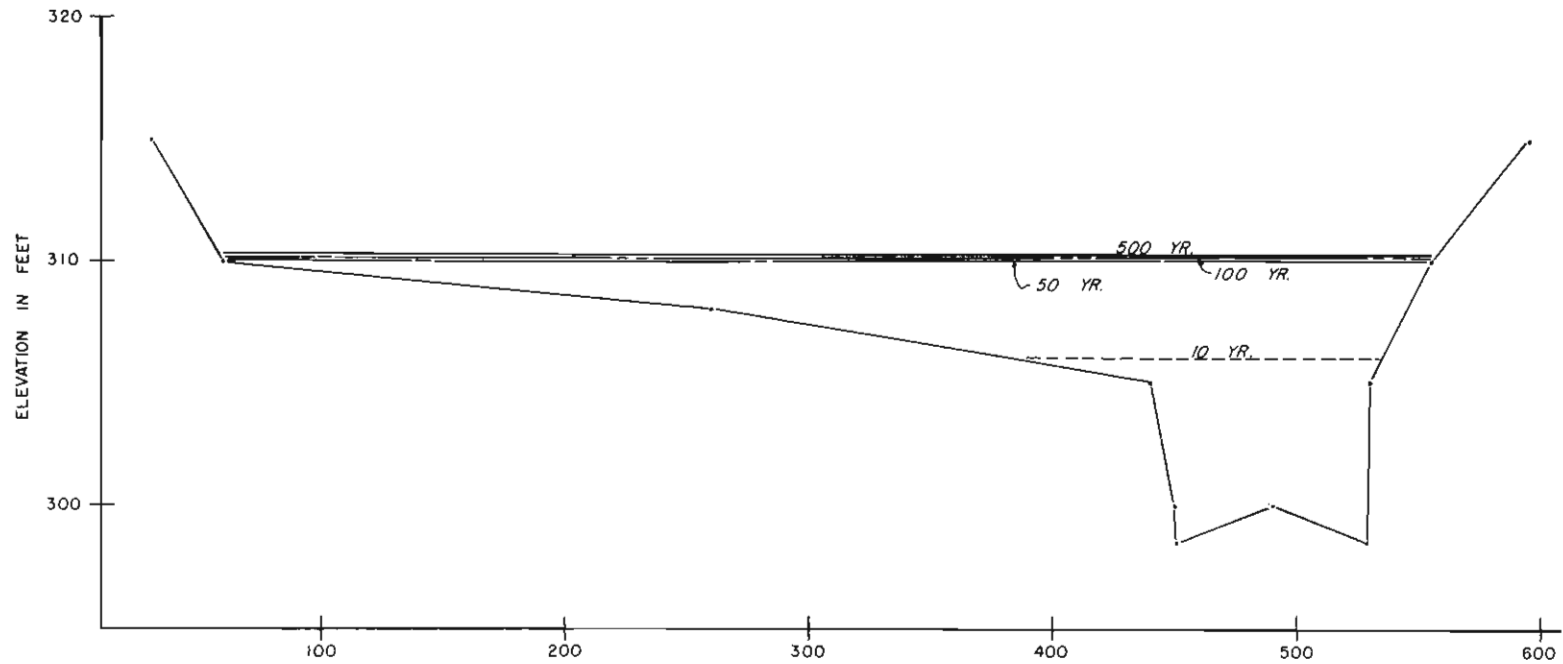

DISTANCE IN FEET
SECTION C-AX
COTTONWOOD CREEK

SOIL CONSERVATION SERVICE
U.S. DEPARTMENT OF AGRICULTURE
TALKEETNA SUBBASIN
MATANUSKA - SUSITNA BOROUGH, ALASKA

FIGURE 71

TYPICAL VALLEY SECTION
PRESENT CONDITIONS

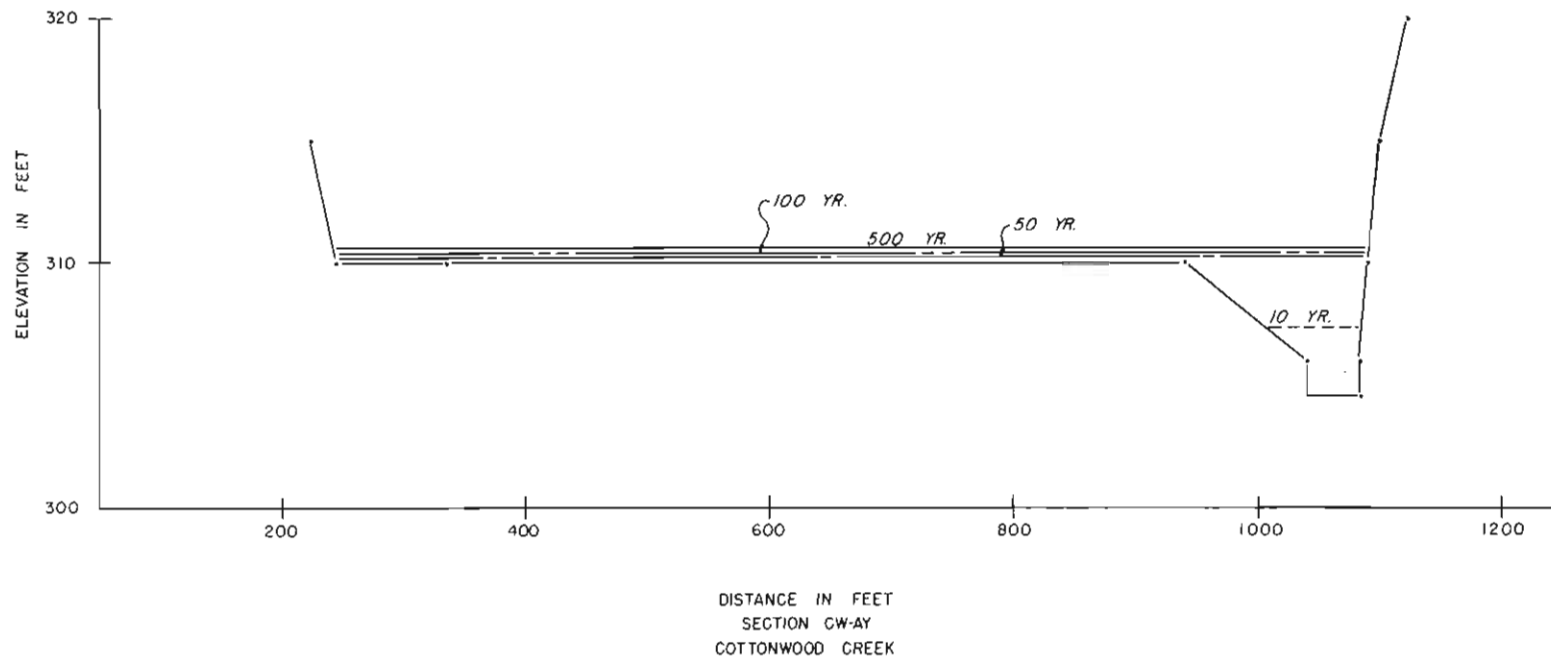

SOIL CONSERVATION SERVICE
U.S. DEPARTMENT OF AGRICULTURE
TALKEENA SUBBASIN
MATANUSKA-SUSITNA BOROUGH, ALASKA

FIGURE 72

TYPICAL VALLEY SECTION
PRESENT CONDITIONS

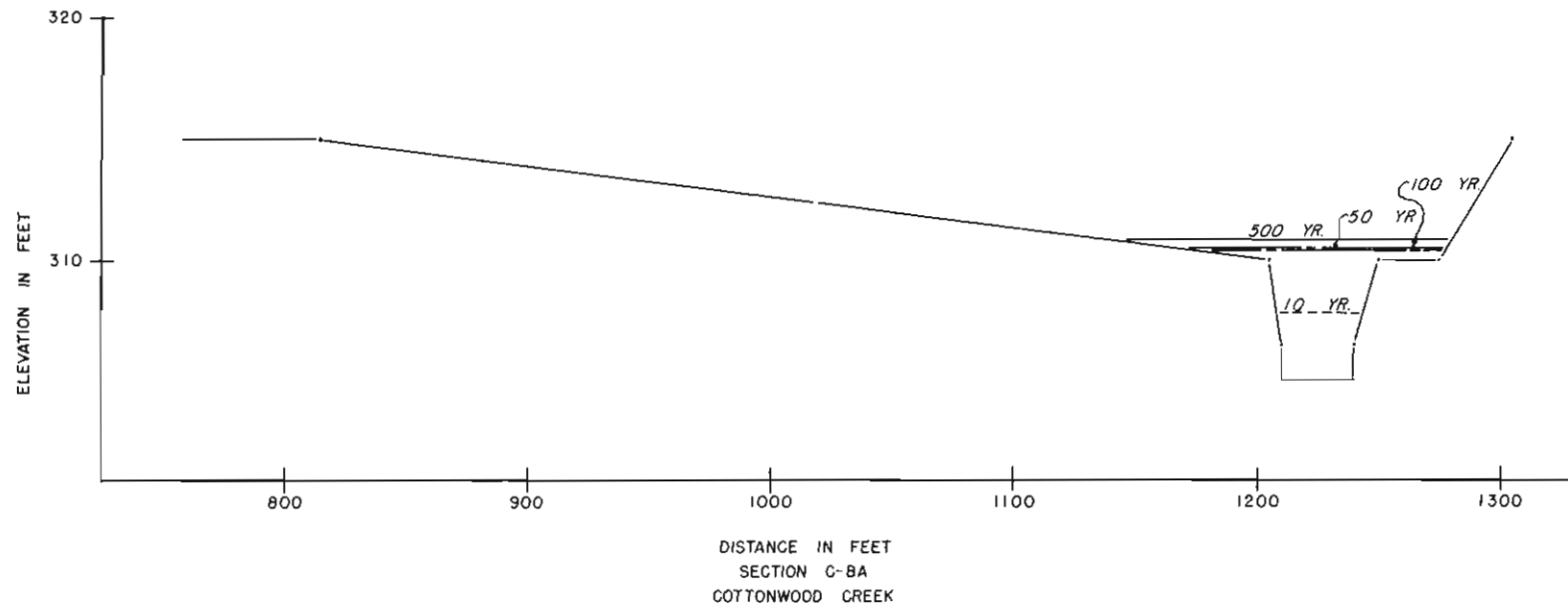

SOIL CONSERVATION SERVICE
U.S. DEPARTMENT OF AGRICULTURE
TALKEETNA SUBBASIN
MATANUSKA-SUSITNA BOROUGH, ALASKA

FIGURE 73

TYPICAL VALLEY SECTION
PRESENT CONDITIONS

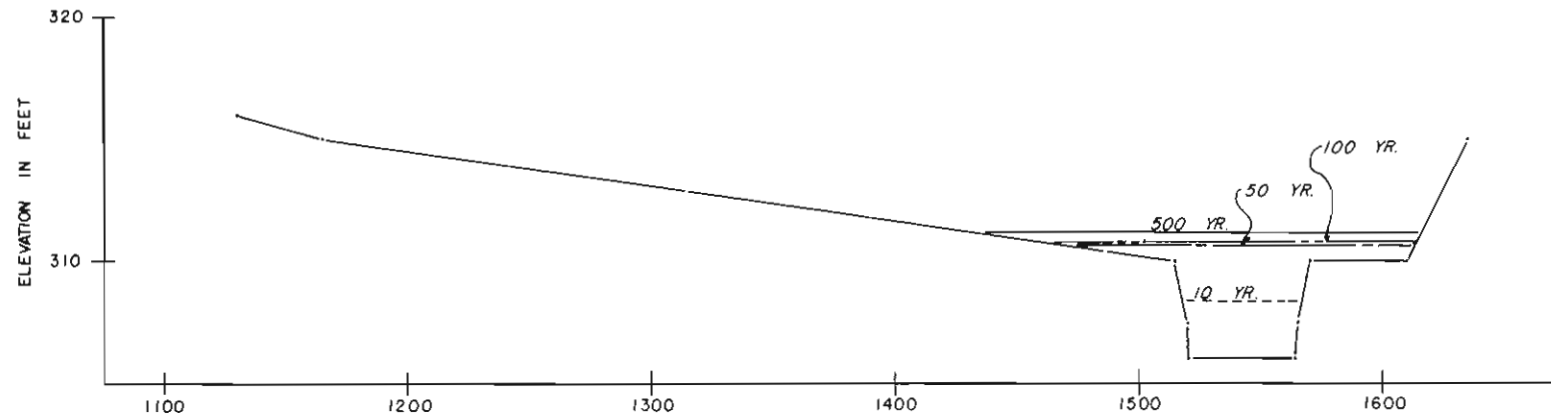

DISTANCE IN FEET
SECTION C-BB
COTTONWOOD CREEK

SOIL CONSERVATION SERVICE
U.S. DEPARTMENT OF AGRICULTURE
TALKEETNA SUBBASIN
MATANUSKA-SUSITNA BOROUGH, ALASKA

FIGURE 74

TYPICAL VALLEY SECTION
PRESENT CONDITIONS

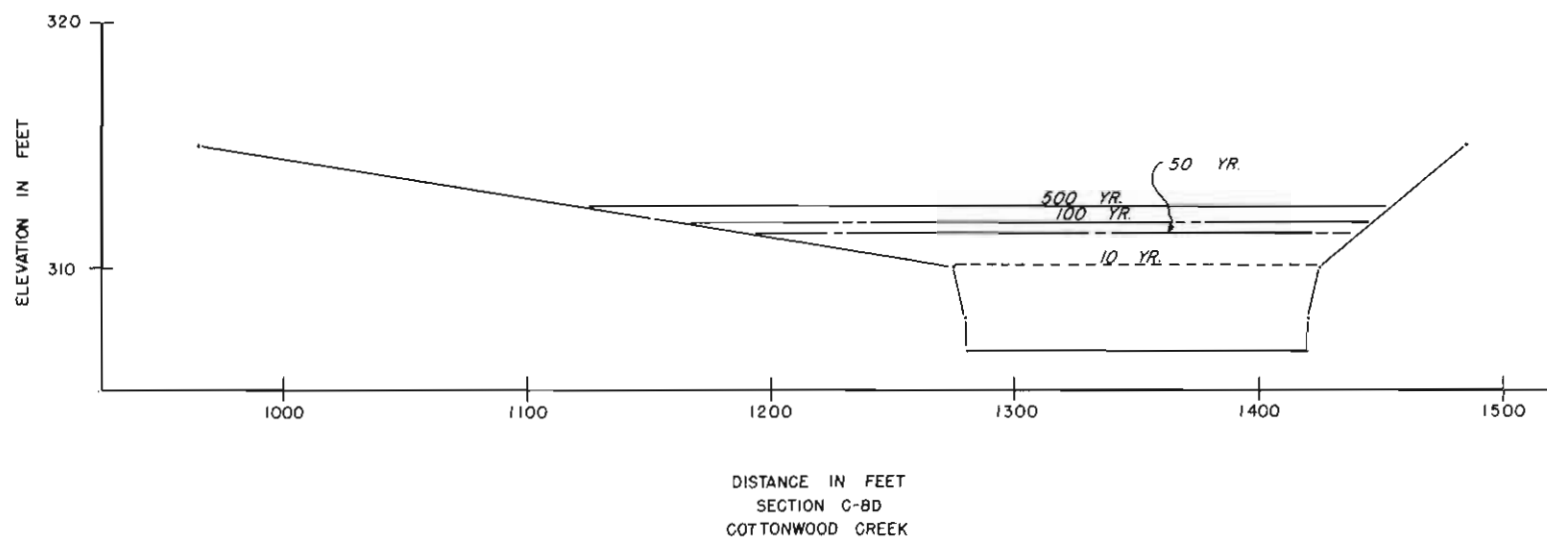

SOIL CONSERVATION SERVICE
U.S. DEPARTMENT OF AGRICULTURE
TALKEETNA SUBBASIN
MATANUSKA-SUSITNA BOROUGH, ALASKA

FIGURE 75

TYPICAL VALLEY SECTION
PRESENT CONDITIONS

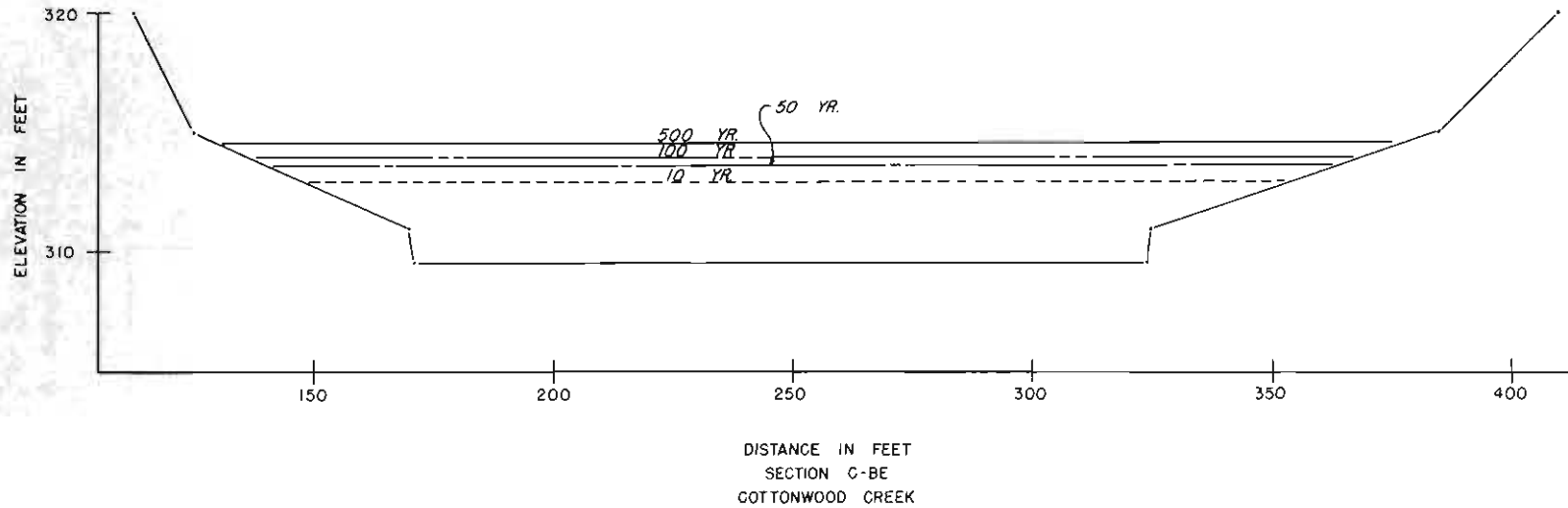

SOIL CONSERVATION SERVICE
U.S. DEPARTMENT OF AGRICULTURE
TALKEETNA SUBBASIN
MATANUSKA-SUSITNA BOROUGH, ALASKA

FIGURE 76

TYPICAL VALLEY SECTION
PRESENT CONDITIONS

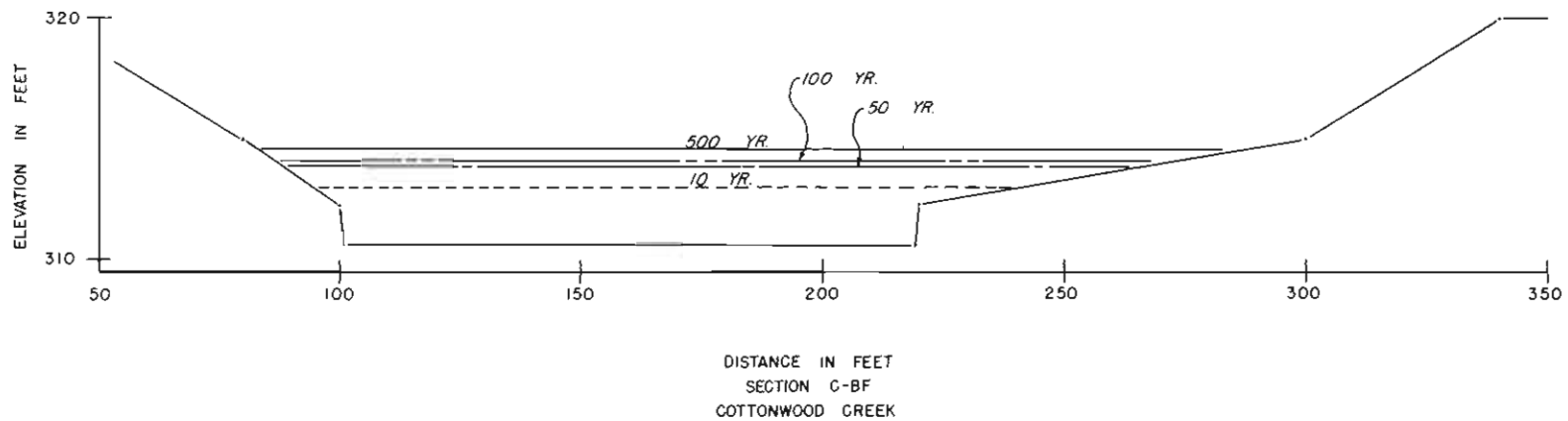

SOIL CONSERVATION SERVICE
U.S. DEPARTMENT OF AGRICULTURE
TALKEETNA SUBBASIN
MATANUSKA-SUSITNA BOROUGH, ALASKA

FIGURE 77

TYPICAL VALLEY SECTION
PRESENT CONDITIONS

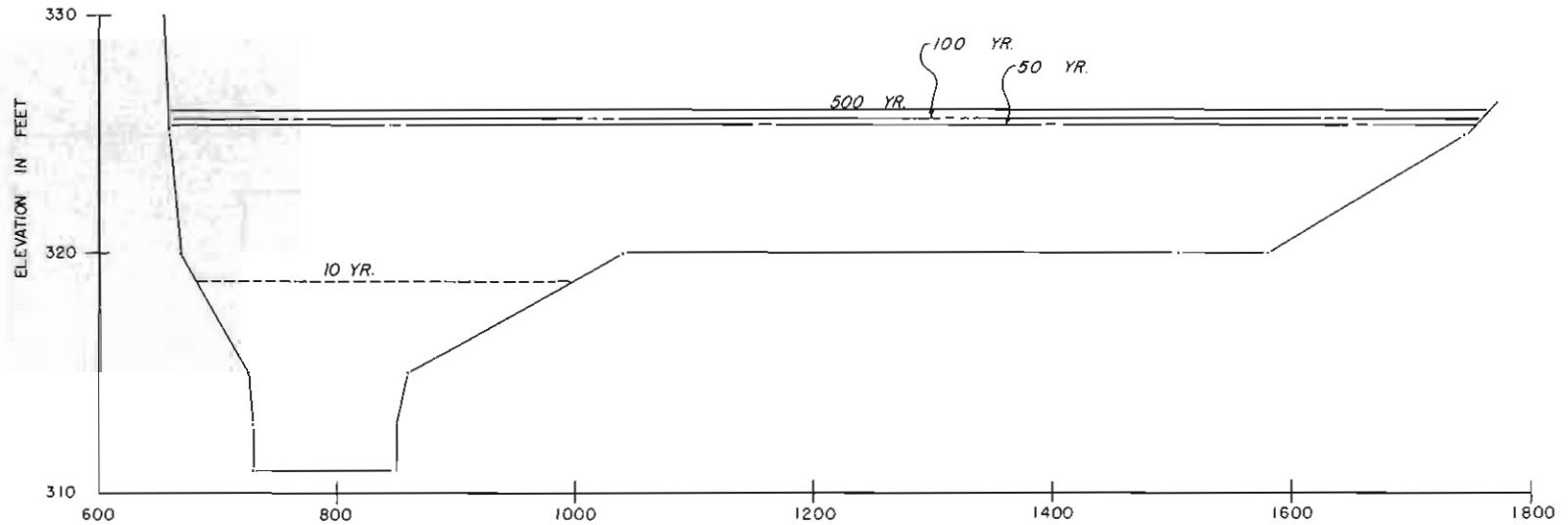

DISTANCE IN FEET
SECTION C-BH
COTTONWOOD CREEK

SOIL CONSERVATION SERVICE
U.S. DEPARTMENT OF AGRICULTURE
TALKEETNA SUBBASIN
MATANUSKA-SUSITNA BOROUGH, ALASKA

FIGURE 78

TYPICAL VALLEY SECTION
PRESENT CONDITIONS

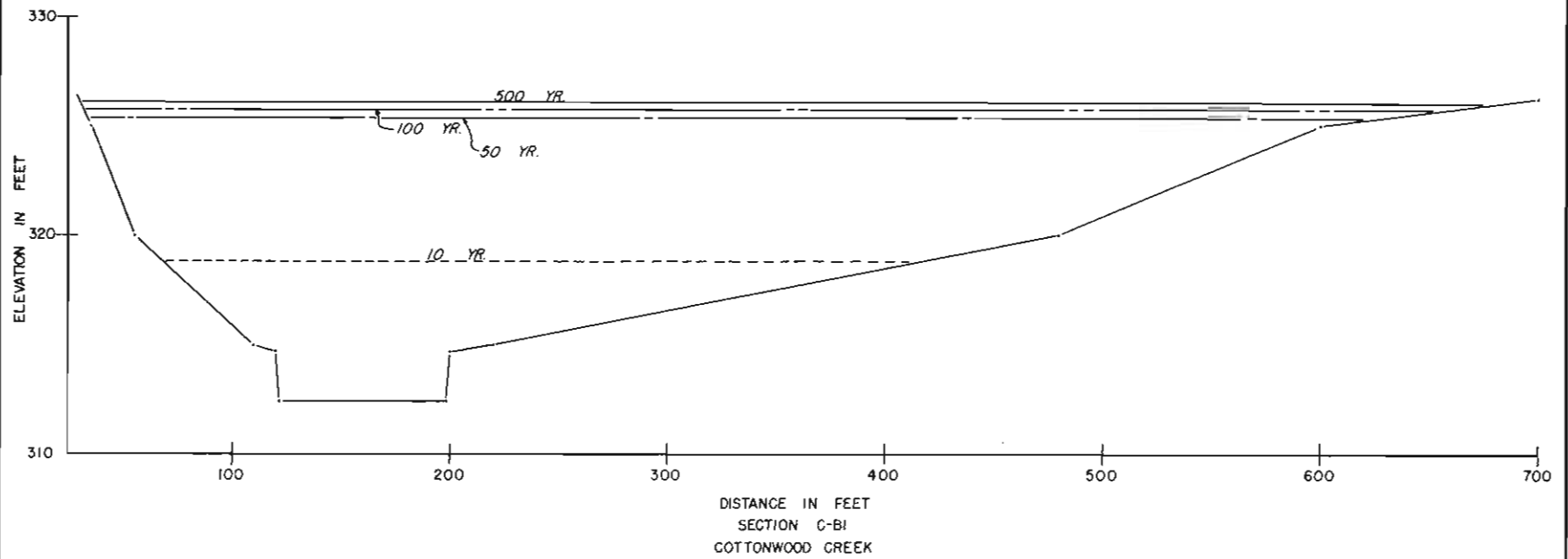

SOIL CONSERVATION SERVICE
U.S. DEPARTMENT OF AGRICULTURE
TALKEETNA SUBBASIN
MATANUSKA-SUSITNA BOROUGH, ALASKA

FIGURE 79

TYPICAL VALLEY SECTION
PRESENT CONDITIONS

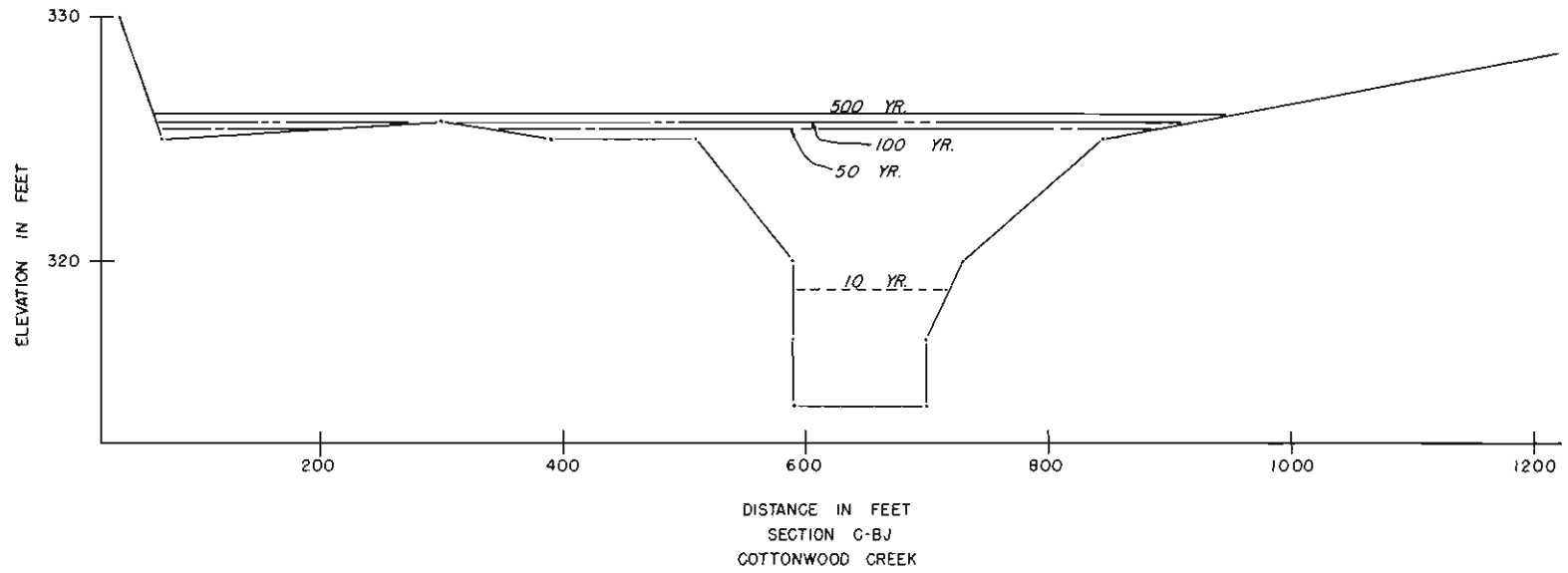

SOIL CONSERVATION SERVICE
U.S. DEPARTMENT OF AGRICULTURE
TALKEETNA SUBBASIN
MATANUSKA-SUSITNA BOROUGH, ALASKA

FIGURE 80

TYPICAL VALLEY SECTION
PRESENT CONDITIONS

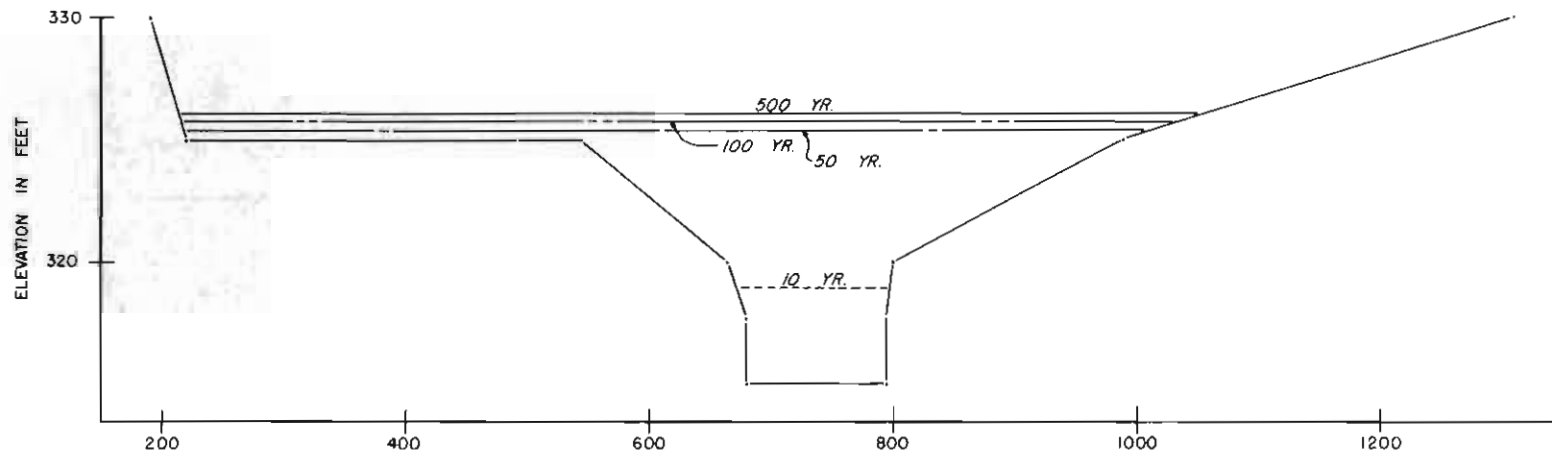

DISTANCE IN FEET
SECTION C-BK
COTTONWOOD CREEK

SOIL CONSERVATION SERVICE
U.S. DEPARTMENT OF AGRICULTURE
TALKEETNA SUBBASIN
MATANUSKA-SUSITNA BOROUGH, ALASKA

FIGURE 81

TYPICAL VALLEY SECTION
PRESENT CONDITIONS

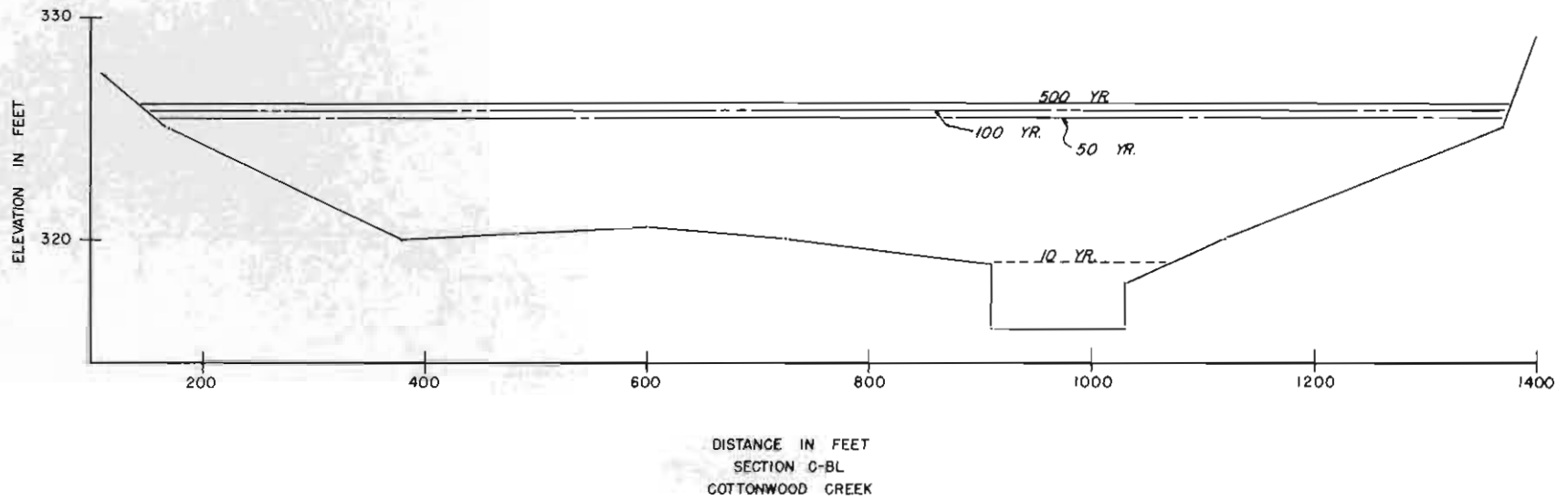

SOIL CONSERVATION SERVICE
U.S. DEPARTMENT OF AGRICULTURE
TALKEETNA SUBBASIN
MATANUSKA-SUSITNA BOROUGH, ALASKA

FIGURE 82

TYPICAL VALLEY SECTION
PRESENT CONDITIONS

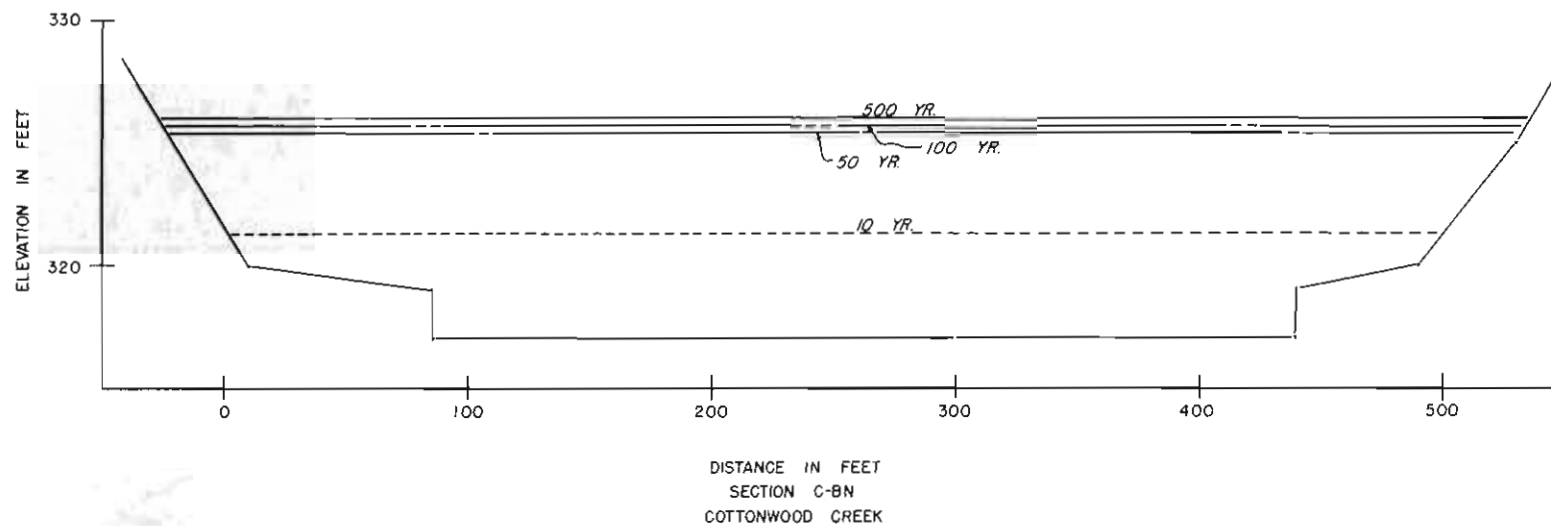

SOIL CONSERVATION SERVICE
U.S. DEPARTMENT OF AGRICULTURE
TALKEETNA SUBBASIN
MATANUSKA - SUSITNA BOROUGH, ALASKA

FIGURE 83

TYPICAL VALLEY SECTION
PRESENT CONDITIONS

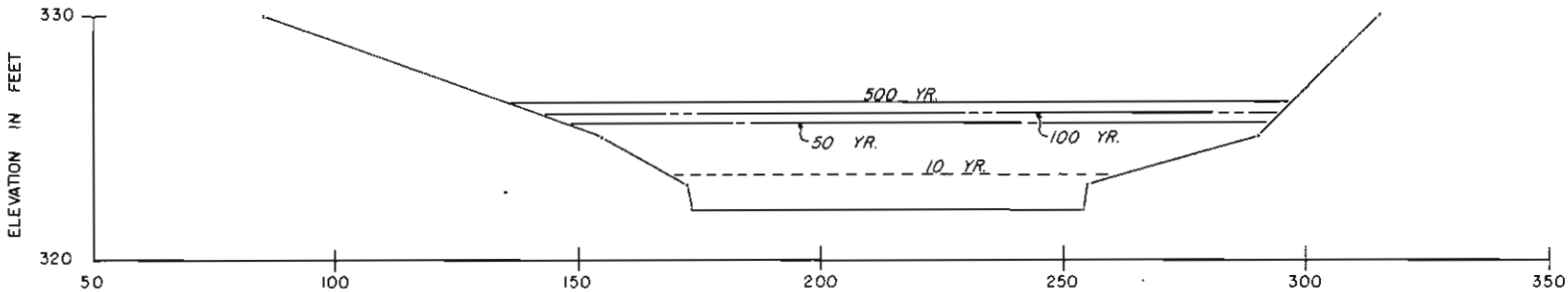

DISTANCE IN FEET
SECTION C-BQ
COTTONWOOD CREEK

SOIL CONSERVATION SERVICE
U.S. DEPARTMENT OF AGRICULTURE
TALKEETNA SUBBASIN
MATANUSKA-SUSITNA BOROUGH, ALASKA

FIGURE 85

TYPICAL VALLEY SECTION
PRESENT CONDITIONS

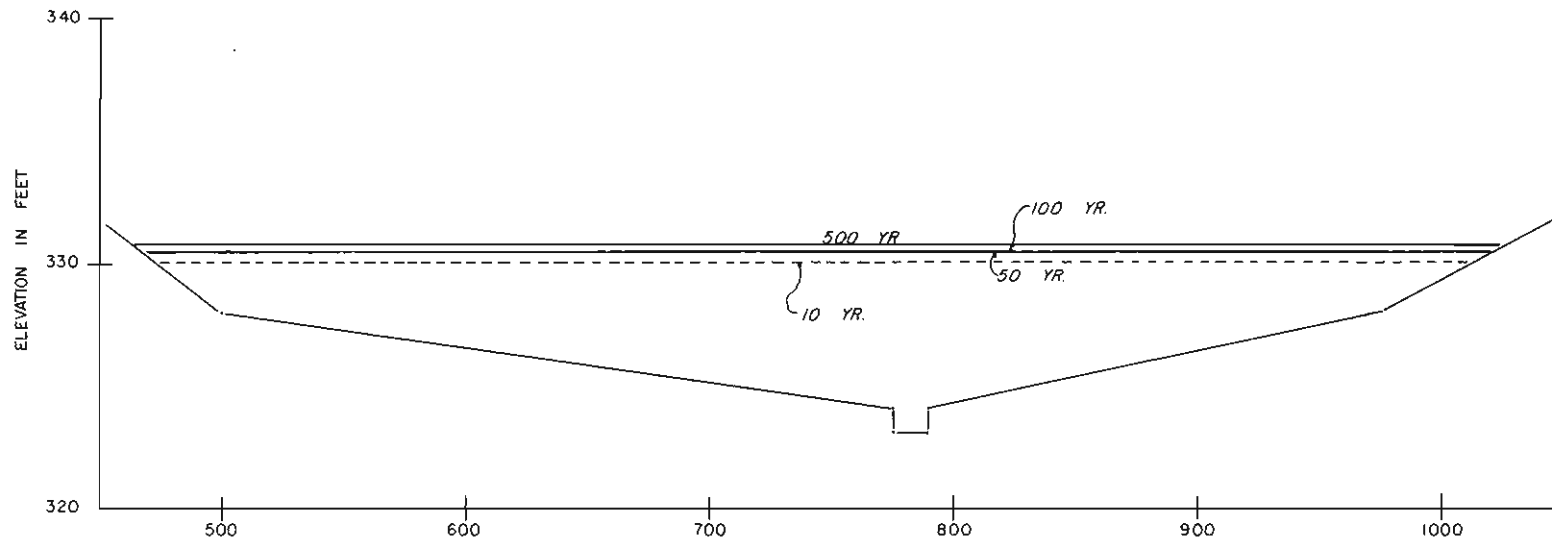

DISTANCE IN FEET
SECTION C-BT
COTTONWOOD CREEK

SOIL CONSERVATION SERVICE
U.S. DEPARTMENT OF AGRICULTURE
TALKEETNA SUBBASIN
MATANUSKA-SUSITNA BOROUGH, ALASKA

FIGURE 87

TYPICAL VALLEY SECTION
PRESENT CONDITIONS

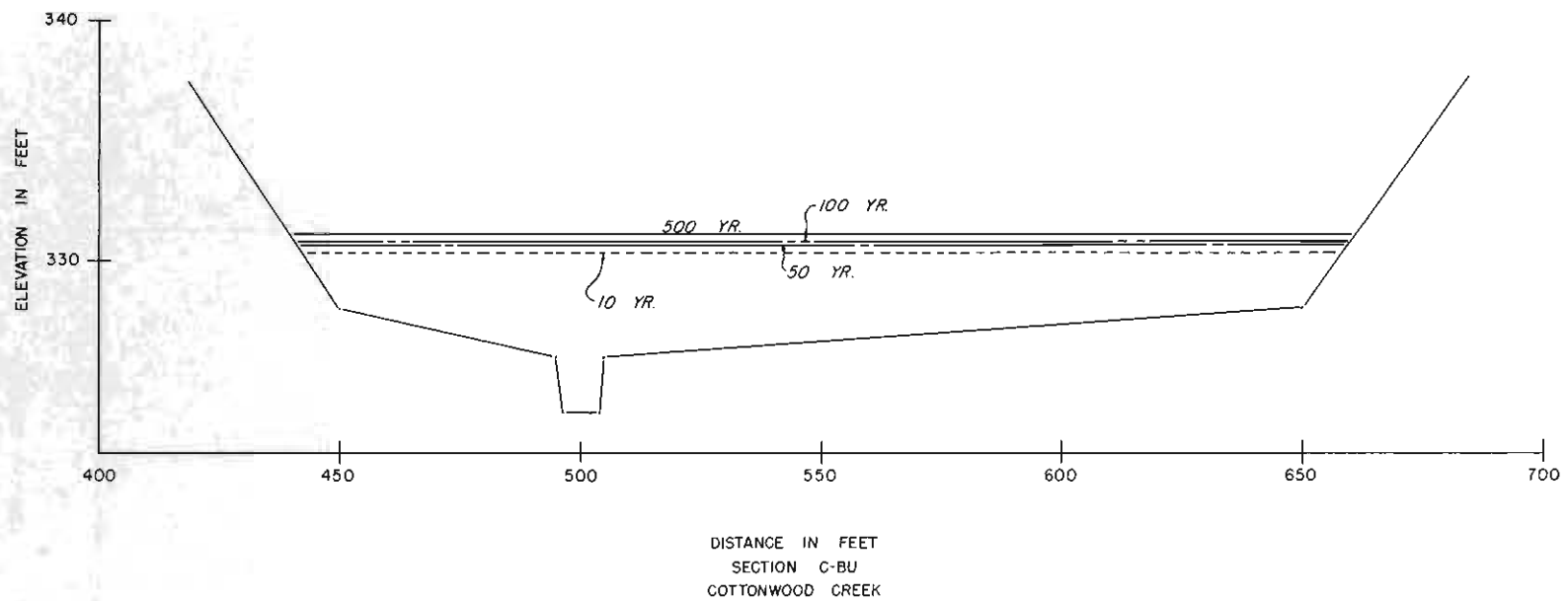

SOIL CONSERVATION SERVICE
U.S. DEPARTMENT OF AGRICULTURE
TALKEETNA SUBBASIN
MATANUSKA - SUSITNA BOROUGH, ALASKA

FIGURE 88

TYPICAL VALLEY SECTION
PRESENT CONDITIONS

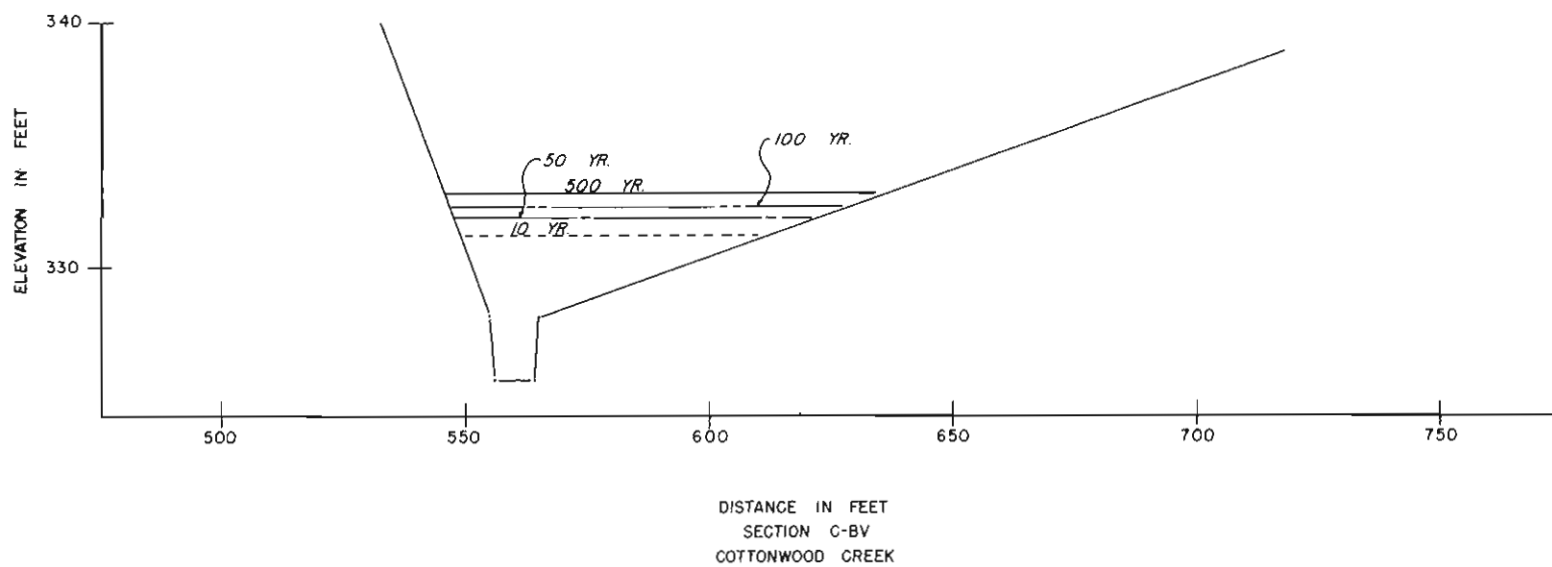

SOIL CONSERVATION SERVICE
U.S. DEPARTMENT OF AGRICULTURE
TALKEETNA SUBBASIN
MATANUSKA-SUSITNA BOROUGH, ALASKA

FIGURE 89

TYPICAL VALLEY SECTION
PRESENT CONDITIONS

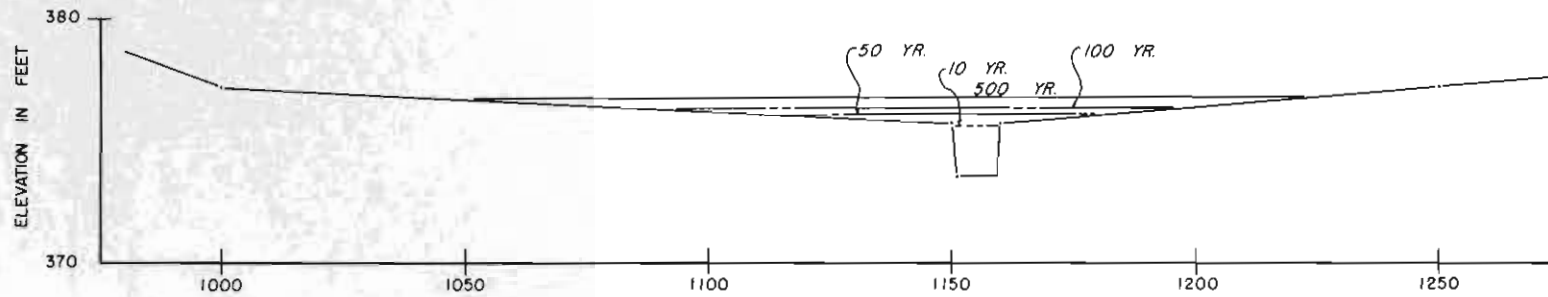

DISTANCE IN FEET
SECTION C-BW
COTTONWOOD CREEK

SOIL CONSERVATION SERVICE
U.S. DEPARTMENT OF AGRICULTURE
TALKEETNA SUBBASIN
MATANUSKA-SUSITNA BOROUGH, ALASKA

FIGURE 90

TYPICAL VALLEY SECTION
PRESENT CONDITIONS

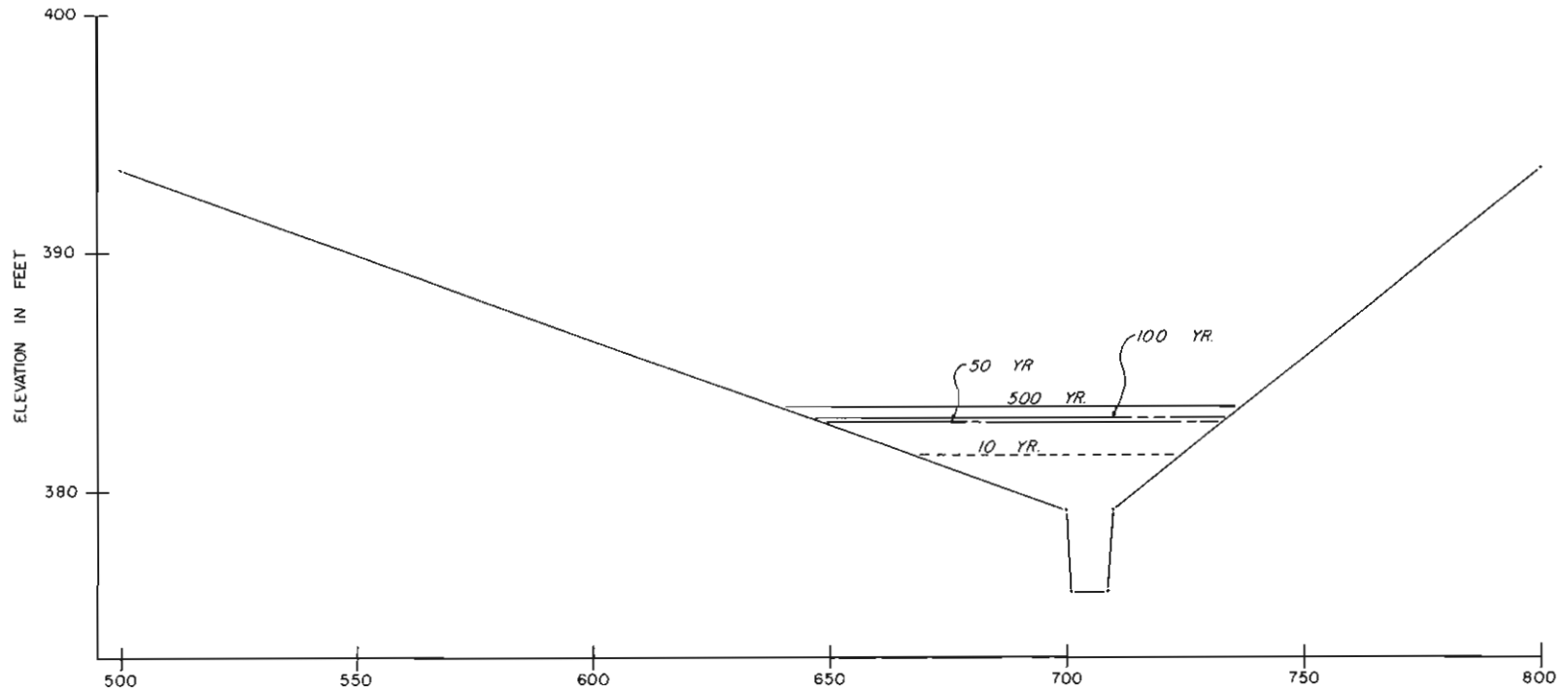

DISTANCE IN FEET
SECTION C-BY
COTTONWOOD CREEK

SOIL CONSERVATION SERVICE
U.S. DEPARTMENT OF AGRICULTURE
TALKEETNA SUBBASIN
MATANUSKA-SUSITNA BOROUGH, ALASKA

FIGURE 91

TYPICAL VALLEY SECTION
PRESENT CONDITIONS

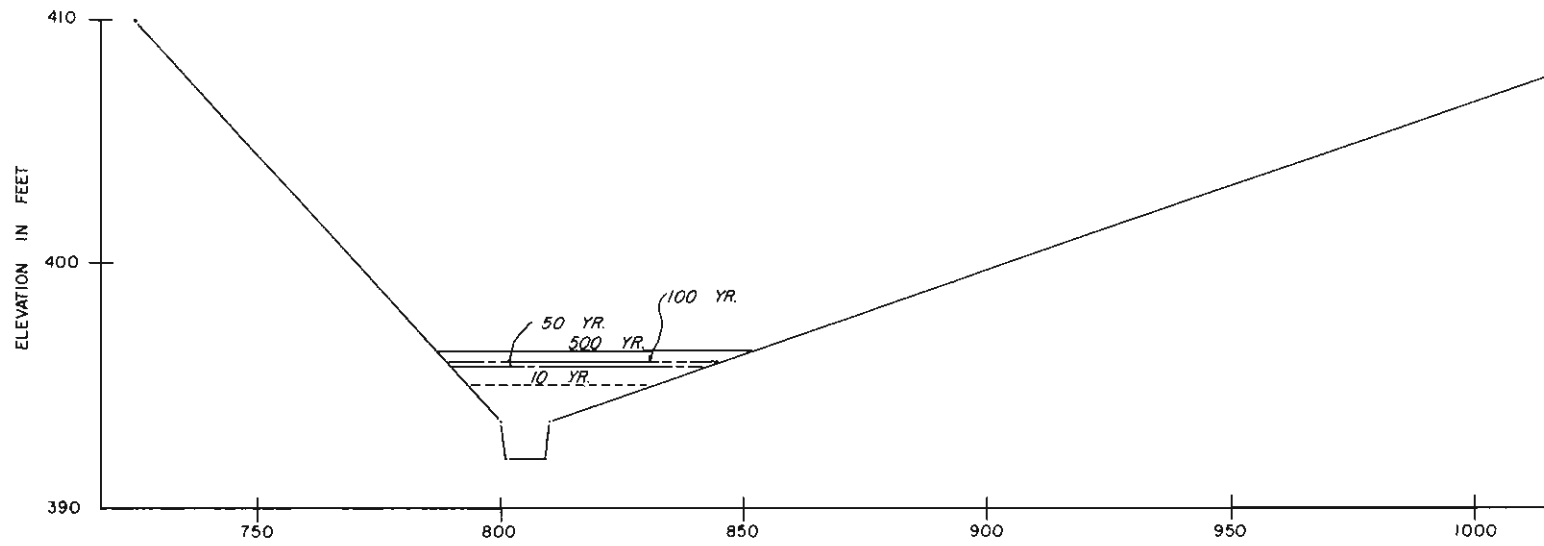

DISTANCE IN FEET
SECTION C-BZ
COTTONWOOD CREEK

SOIL CONSERVATION SERVICE
U.S. DEPARTMENT OF AGRICULTURE
TALKEETNA SUBBASIN
MATANUSKA-SUSITNA BOROUGH, ALASKA

FIGURE 92

TYPICAL VALLEY SECTION
PRESENT CONDITIONS

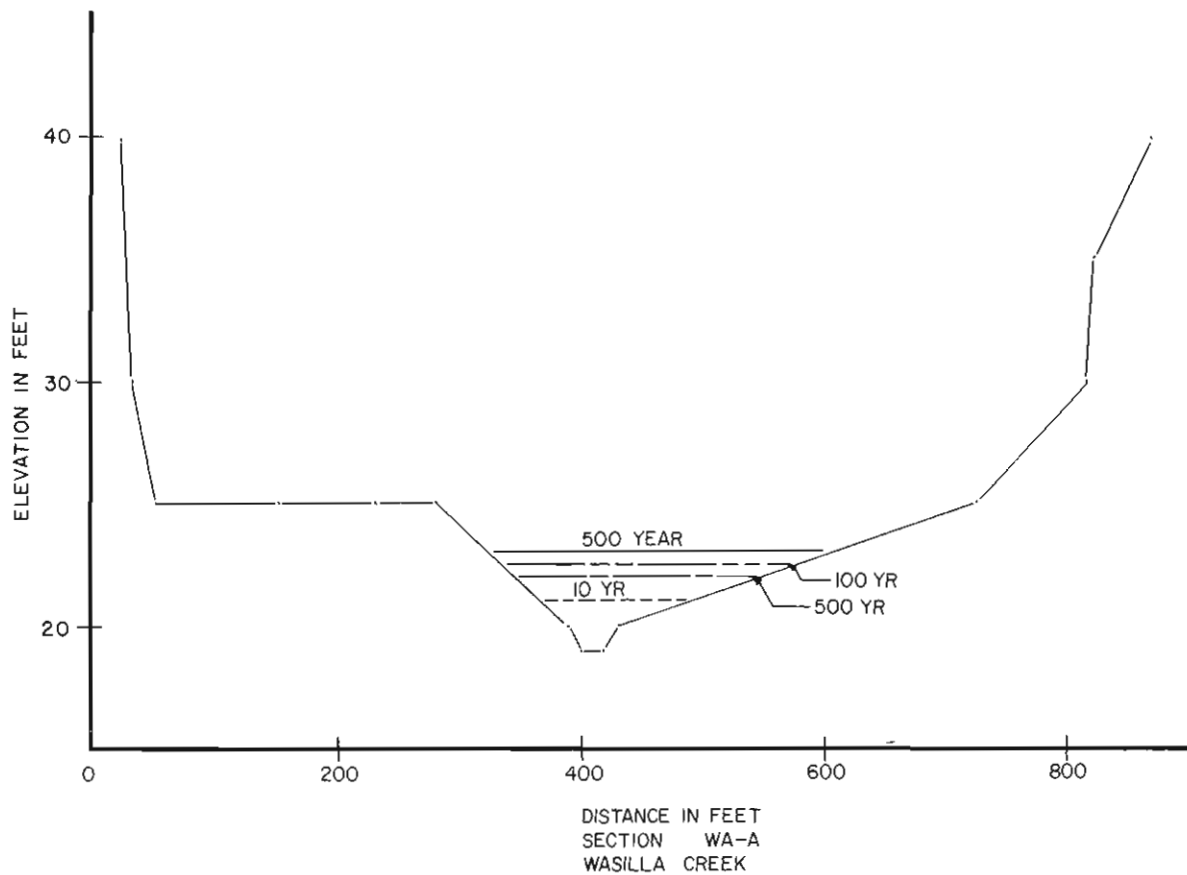

SOIL CONSERVATION SERVICE
U.S. DEPARTMENT OF AGRICULTURE
TALKEETNA SUBBASIN
MATANUSKA - SUSITNA BOROUGH, ALASKA

FIGURE 93

TYPICAL VALLEY SECTION
PRESENT CONDITIONS

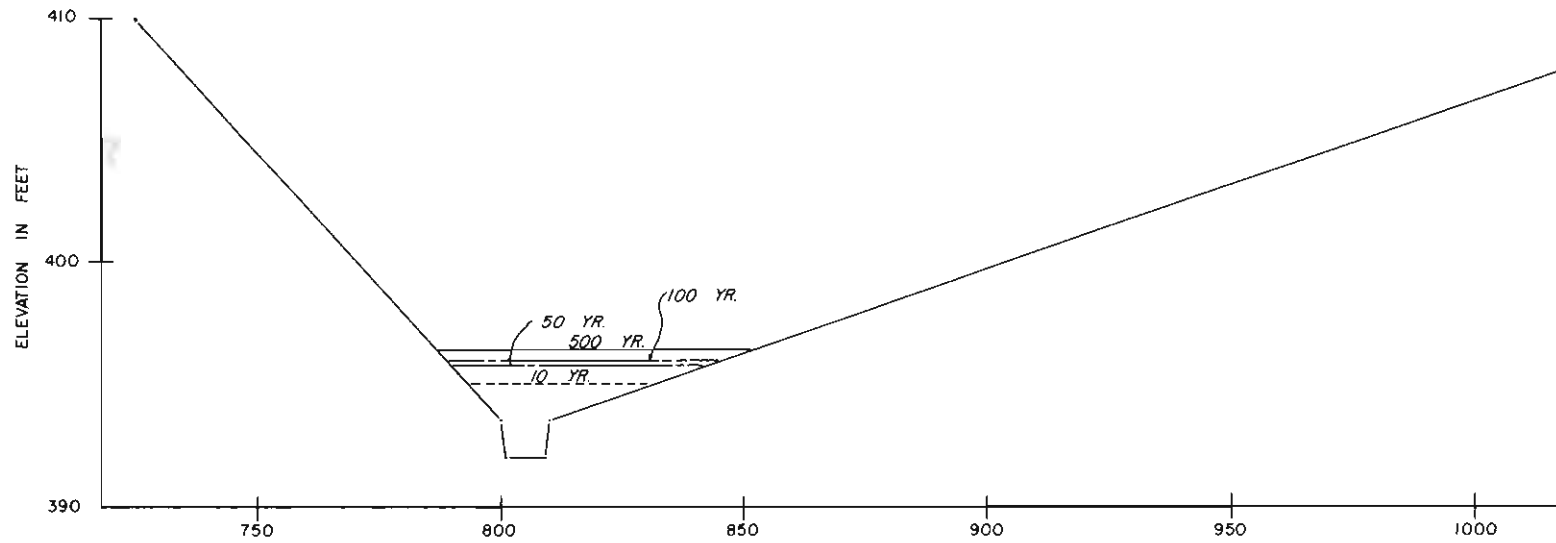

DISTANCE IN FEET
SECTION C-BZ
COTTONWOOD CREEK

SOIL CONSERVATION SERVICE
U.S. DEPARTMENT OF AGRICULTURE
TALKEETNA SUBBASIN
MATANUSKA-SUSITNA BOROUGH, ALASKA

FIGURE 92

TYPICAL VALLEY SECTION
PRESENT CONDITIONS

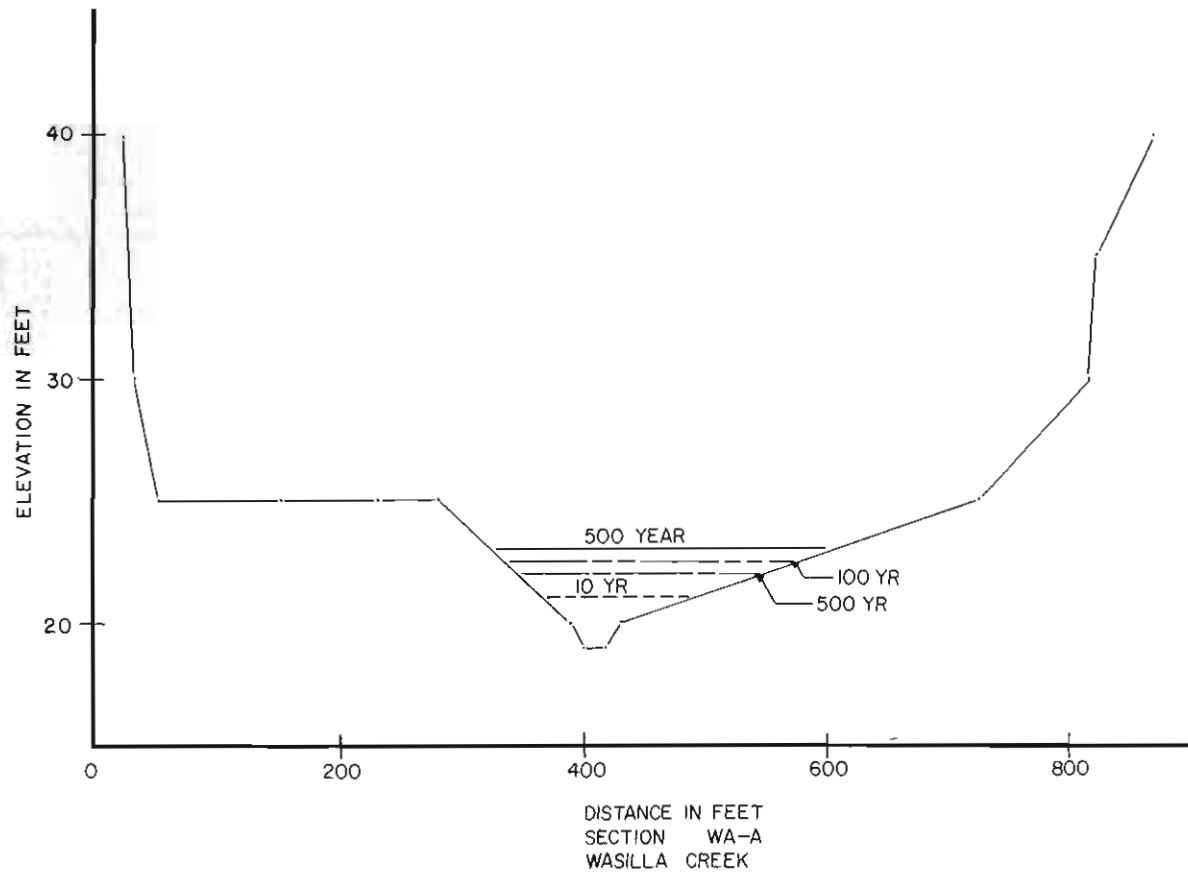

SOIL CONSERVATION SERVICE
U.S. DEPARTMENT OF AGRICULTURE
TALKEETNA SUBBASIN
MATANUSKA - SUSITNA BOROUGH, ALASKA

FIGURE 93

TYPICAL VALLEY SECTION
PRESENT CONDITIONS

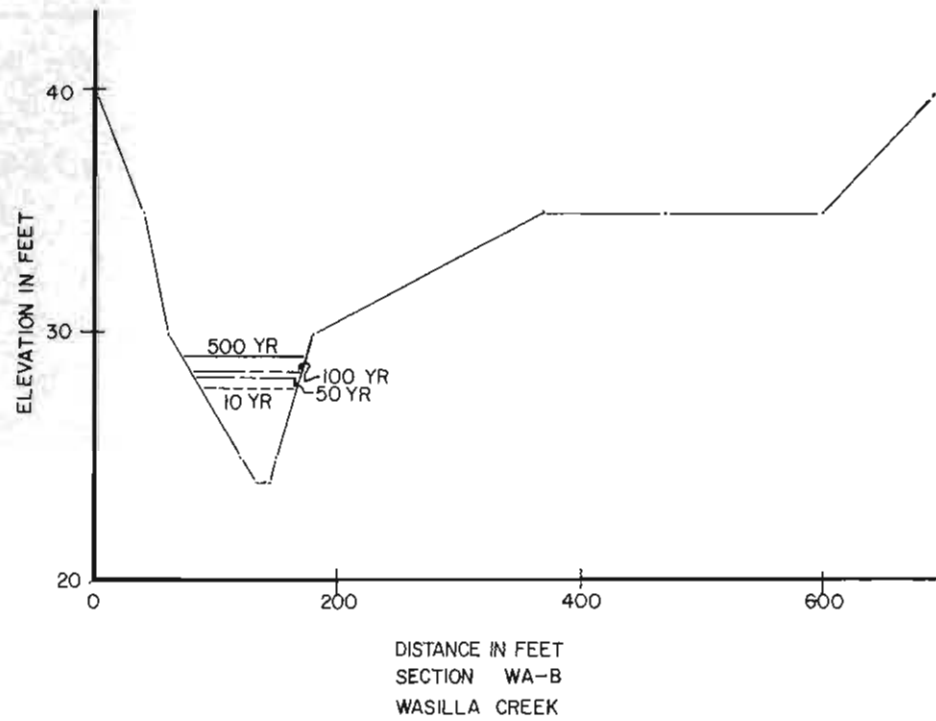

SOIL CONSERVATION SERVICE
U.S. DEPARTMENT OF AGRICULTURE
TALKEETNA SUBBASIN
MATANUSKA - SUSITNA BOROUGH, ALASKA

FIGURE 94

TYPICAL VALLEY SECTION
PRESENT CONDITIONS

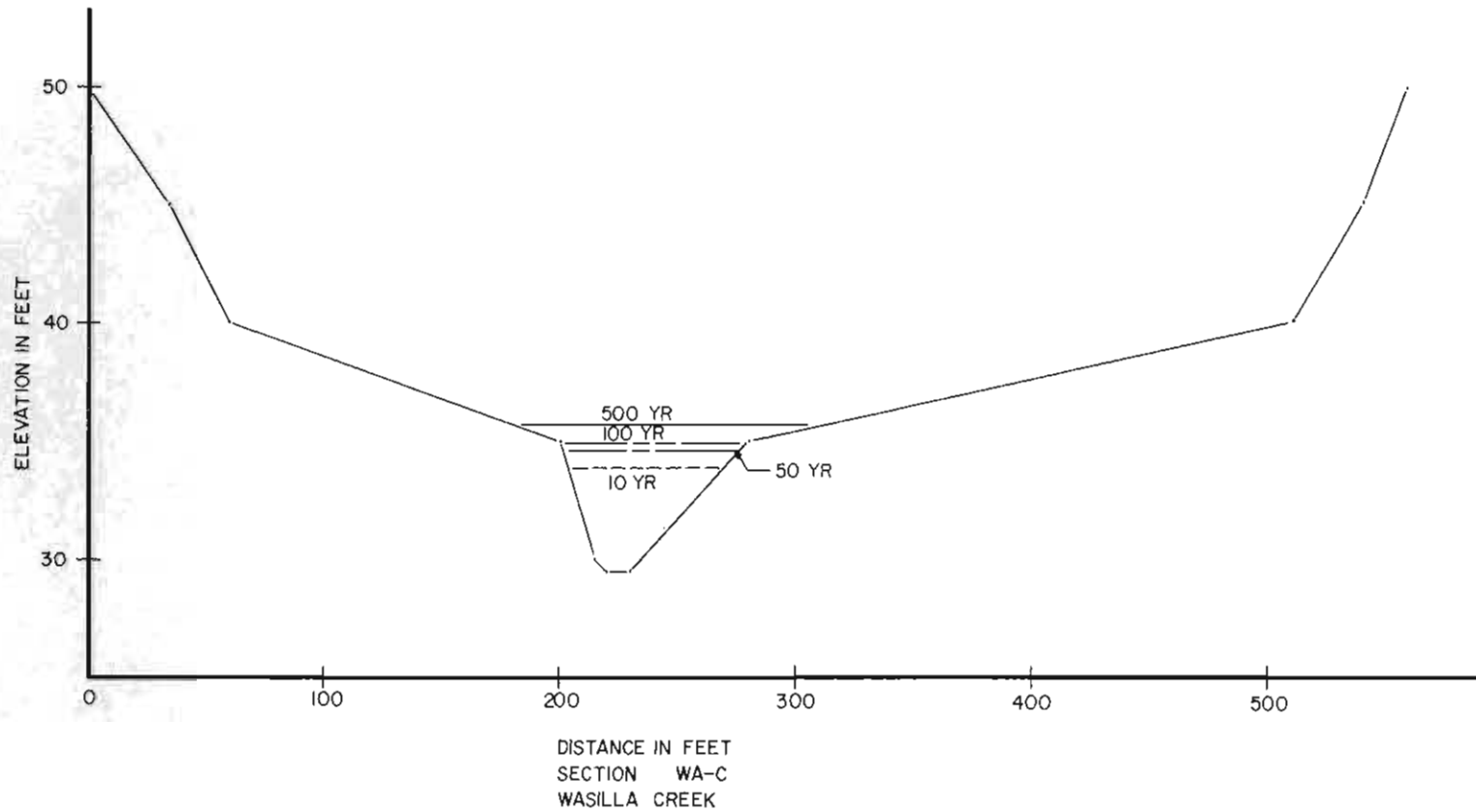

SOIL CONSERVATION SERVICE
U.S. DEPARTMENT OF AGRICULTURE
TALKEETNA SUBBASIN
MATANUSKA-SUSITNA BOROUGH, ALASKA

FIGURE 95

TYPICAL VALLEY SECTION
PRESENT CONDITIONS

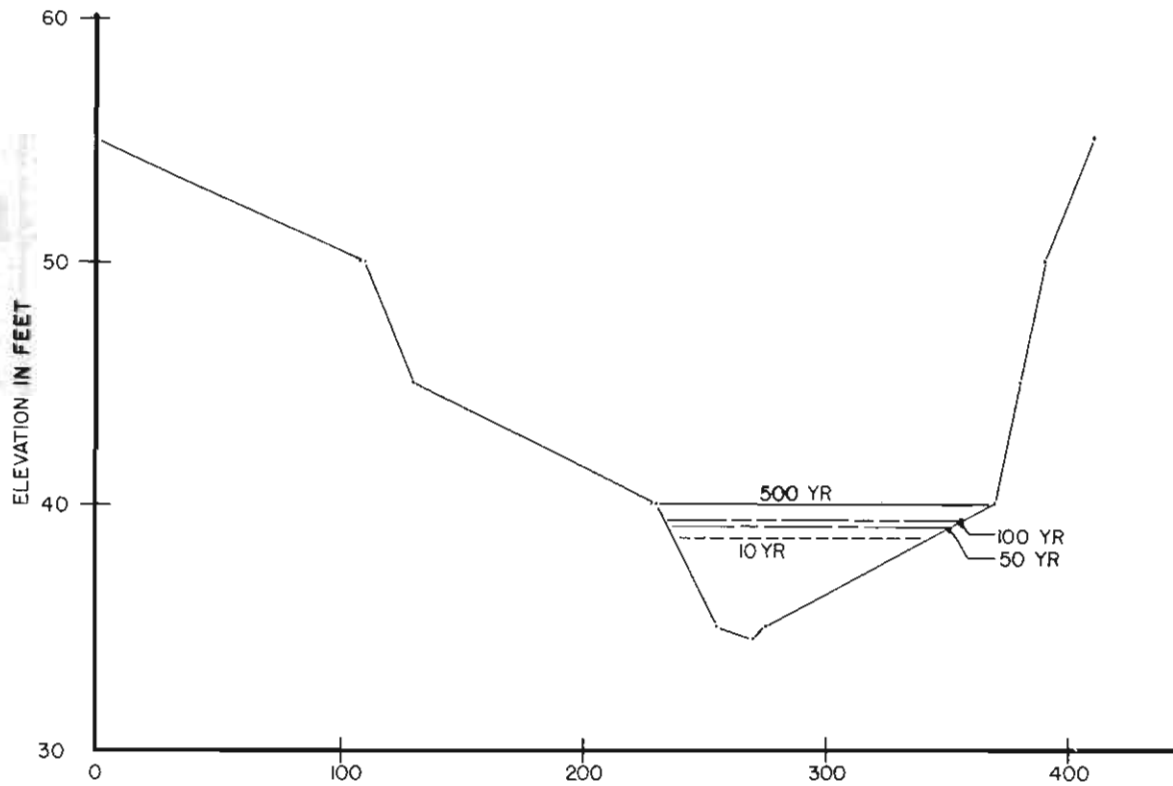

DISTANCE IN FEET
SECTION WA-D
WASILLA CREEK

SOIL CONSERVATION SERVICE
U.S. DEPARTMENT OF AGRICULTURE
TALKEETNA SUBBASIN
MATANUSKA-SUSITNA BOROUGH, ALASKA

FIGURE 96

TYPICAL VALLEY SECTION
PRESENT CONDITIONS

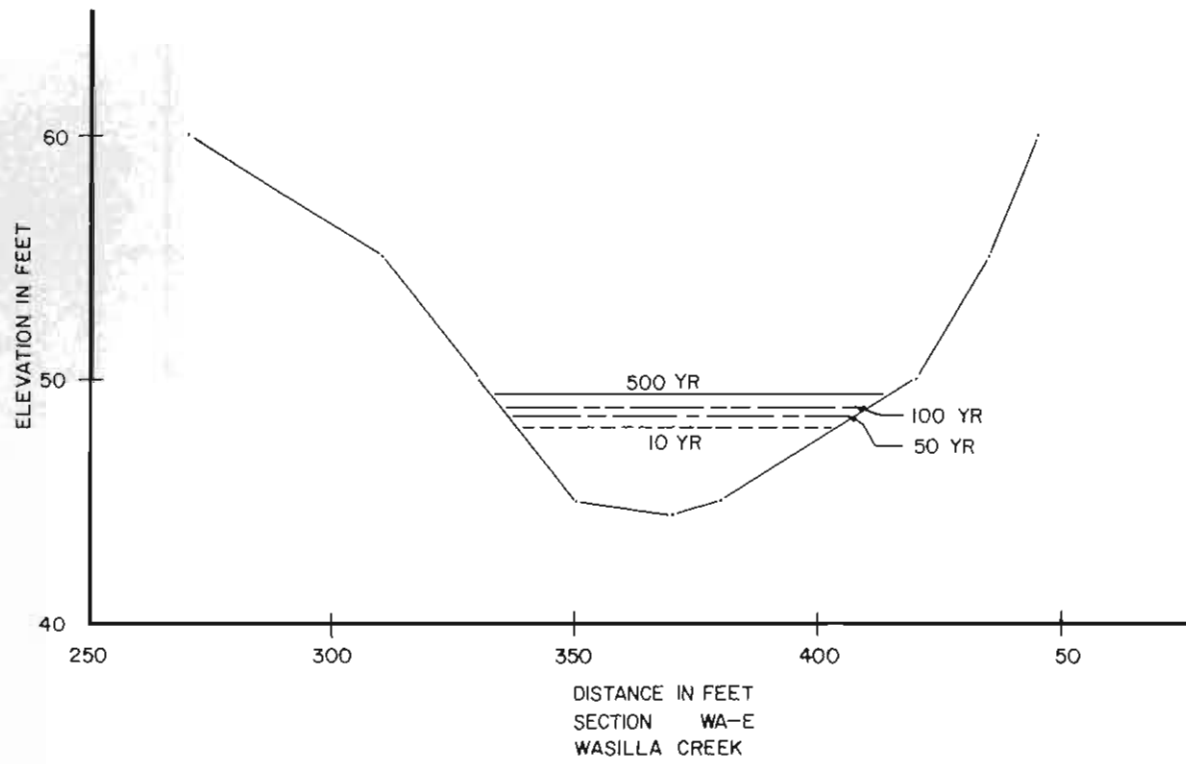

SOIL CONSERVATION SERVICE
U.S. DEPARTMENT OF AGRICULTURE
TALKEETNA SUBBASIN
MATANUSKA-SUSITNA BOROUGH, ALASKA

FIGURE 97

TYPICAL VALLEY SECTION
PRESENT CONDITIONS

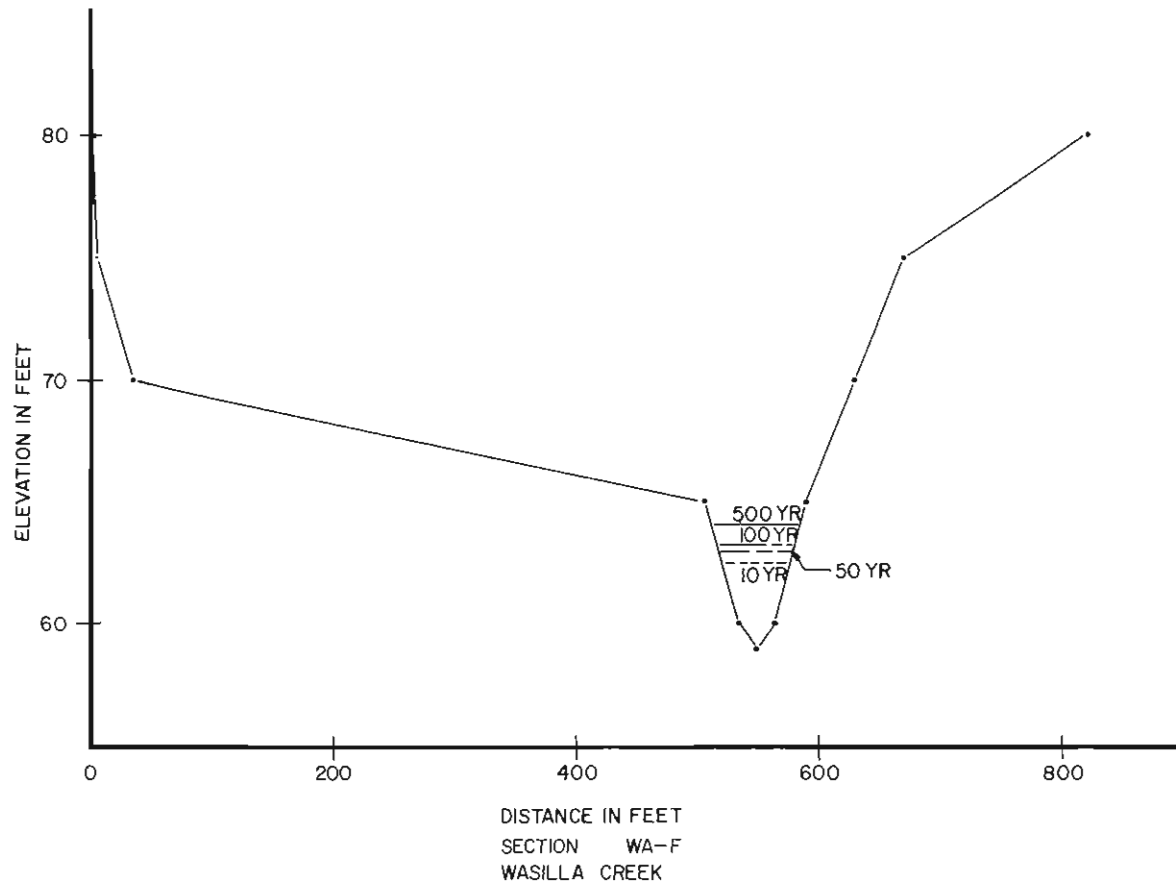

SOIL CONSERVATION SERVICE
U.S. DEPARTMENT OF AGRICULTURE
TALKEETNA SUBBASIN
MATANUSKA-SUSITNA BOROUGH, ALASKA

FIGURE 98

TYPICAL VALLEY SECTION
PRESENT CONDITIONS

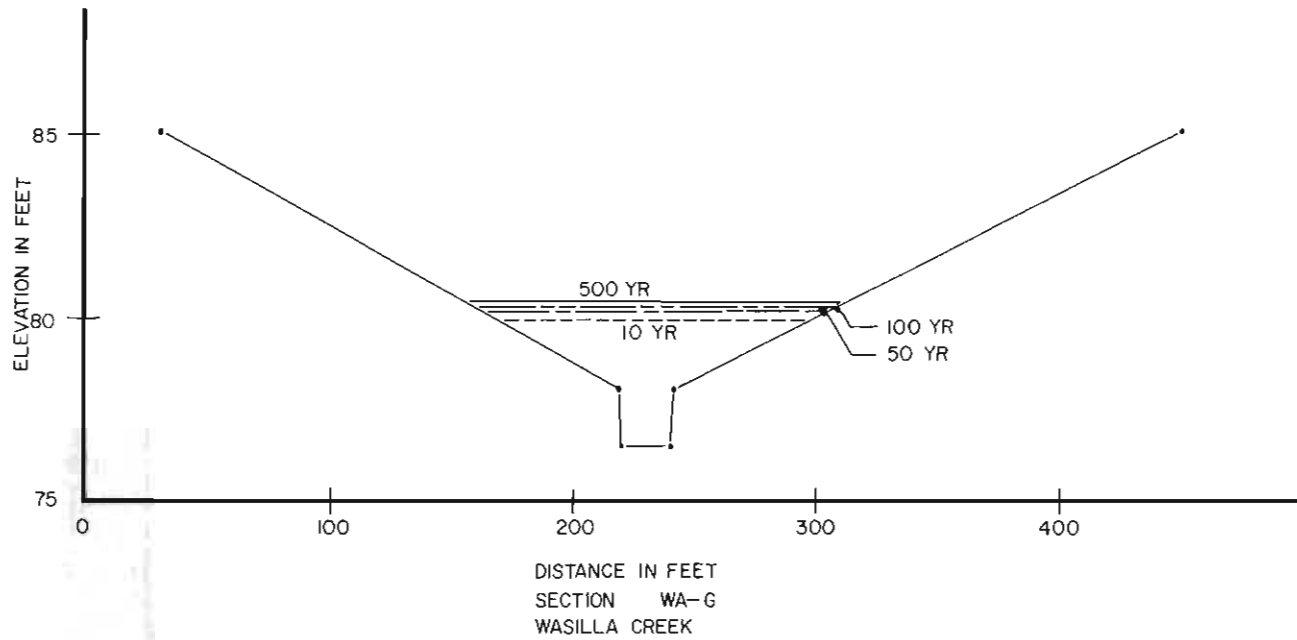

DISTANCE IN FEET
SECTION WA-G
WASILLA CREEK

SOIL CONSERVATION SERVICE
U.S. DEPARTMENT OF AGRICULTURE
TALKEETNA SUBBASIN
MATANUSKA-SUSITNA BOROUGH, ALASKA

FIGURE 99

TYPICAL VALLEY SECTION
PRESENT CONDITIONS

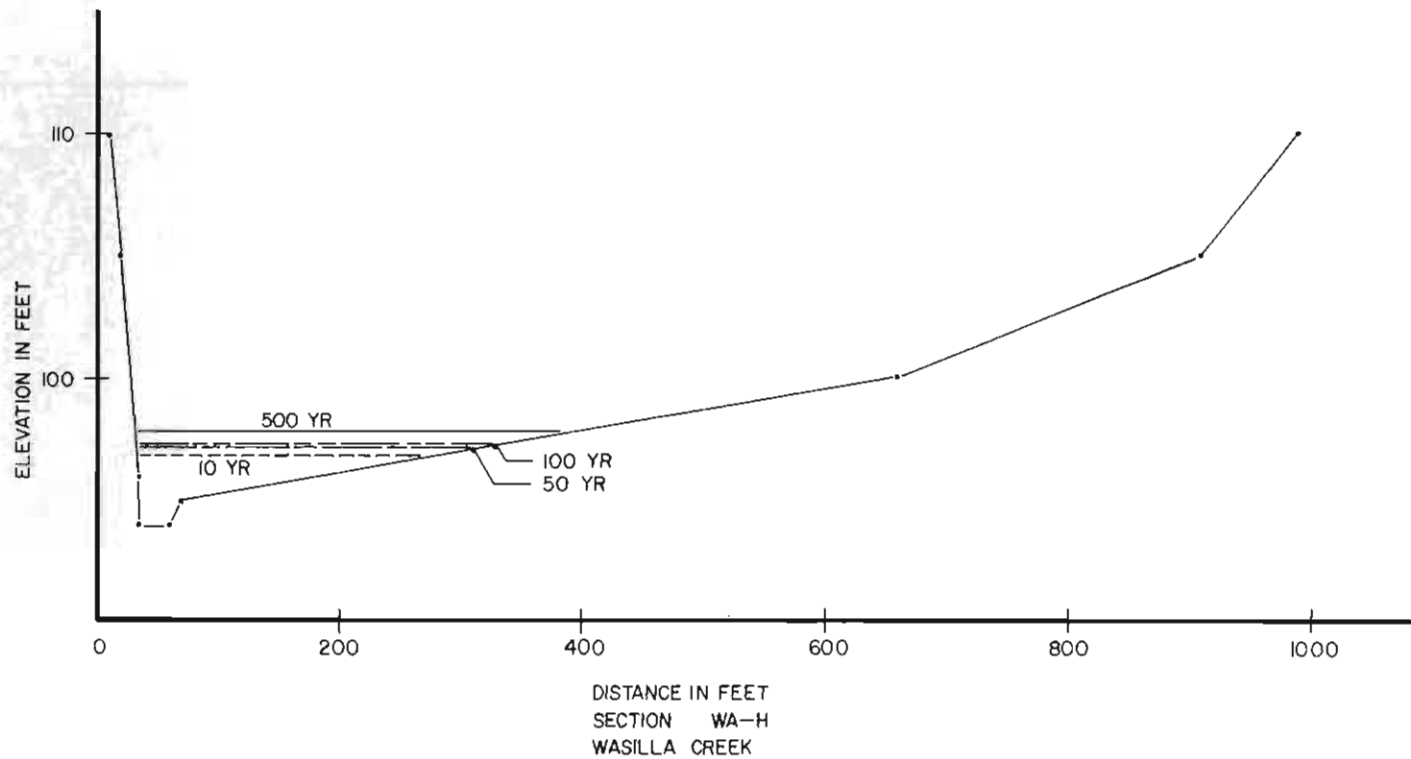

SOIL CONSERVATION SERVICE
U.S. DEPARTMENT OF AGRICULTURE
TALKEETNA SUBBASHN
MATANUSKA-SUSITNA BOROUGH, ALASKA

FIGURE 100

TYPICAL VALLEY SECTION
PRESENT CONDITIONS

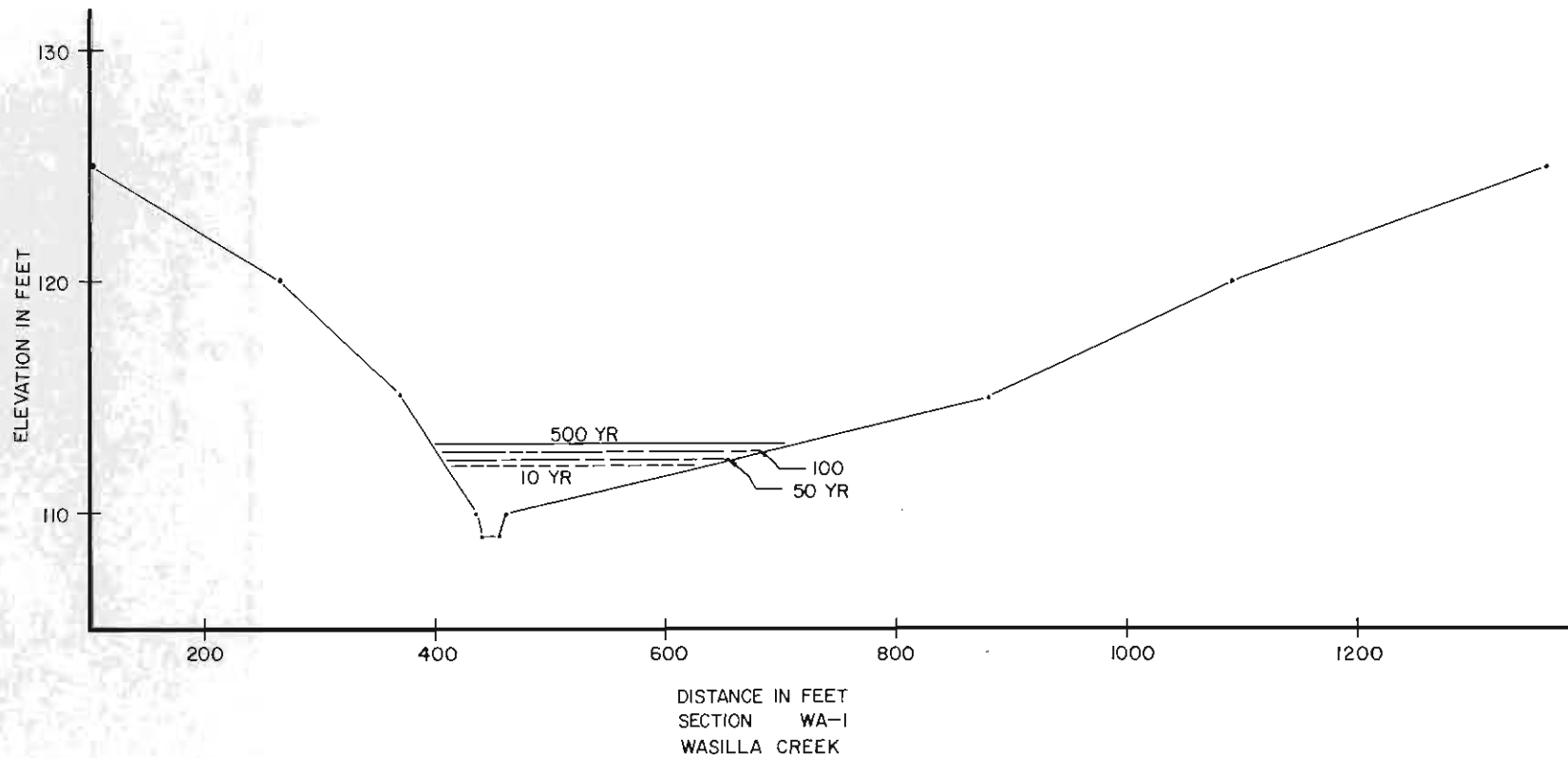

SOIL CONSERVATION SERVICE
U.S. DEPARTMENT OF AGRICULTURE
TALKEETNA SUBBASIN
MATANUSKA-SUSITNA BOROUGH, ALASKA

FIGURE 101

TYPICAL VALLEY SECTION
PRESENT CONDITIONS

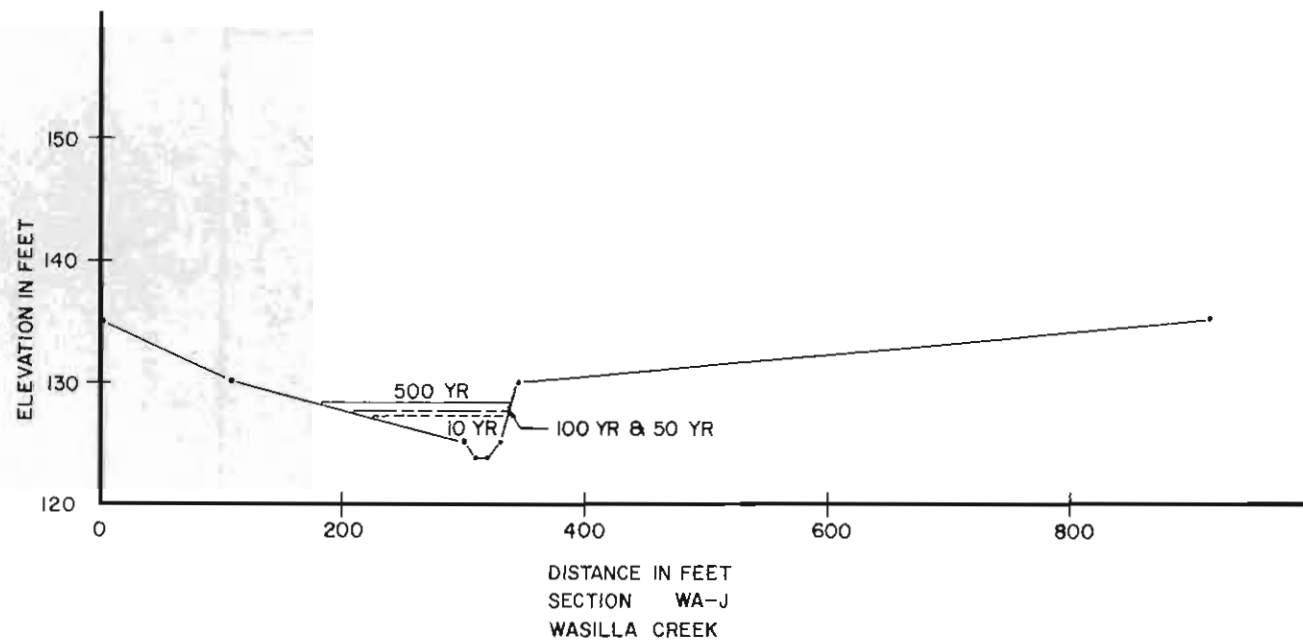

SOIL CONSERVATION SERVICE
U.S. DEPARTMENT OF AGRICULTURE
TALKEETNA SUBBASIN
MATANUSKA-SUSITNA BOROUGH, ALASKA

FIGURE 102

TYPICAL VALLEY SECTION
PRESENT CONDITIONS

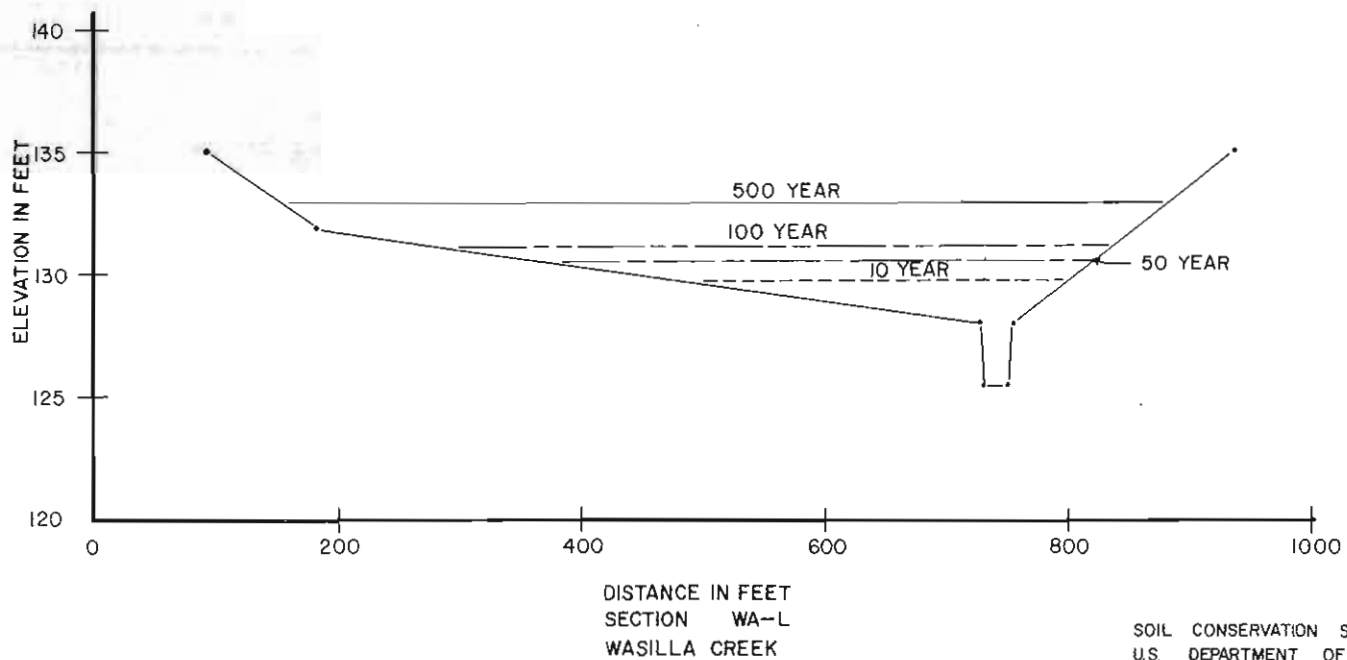

DISTANCE IN FEET
SECTION WA-L
WASILLA CREEK

SOIL CONSERVATION SERVICE
U.S. DEPARTMENT OF AGRICULTURE
TALKEETNA SUBBASIN
MATANUSKA-SUSITNA BOROUGH, ALASKA

FIGURE 103

TYPICAL VALLEY SECTION
PRESENT CONDITIONS

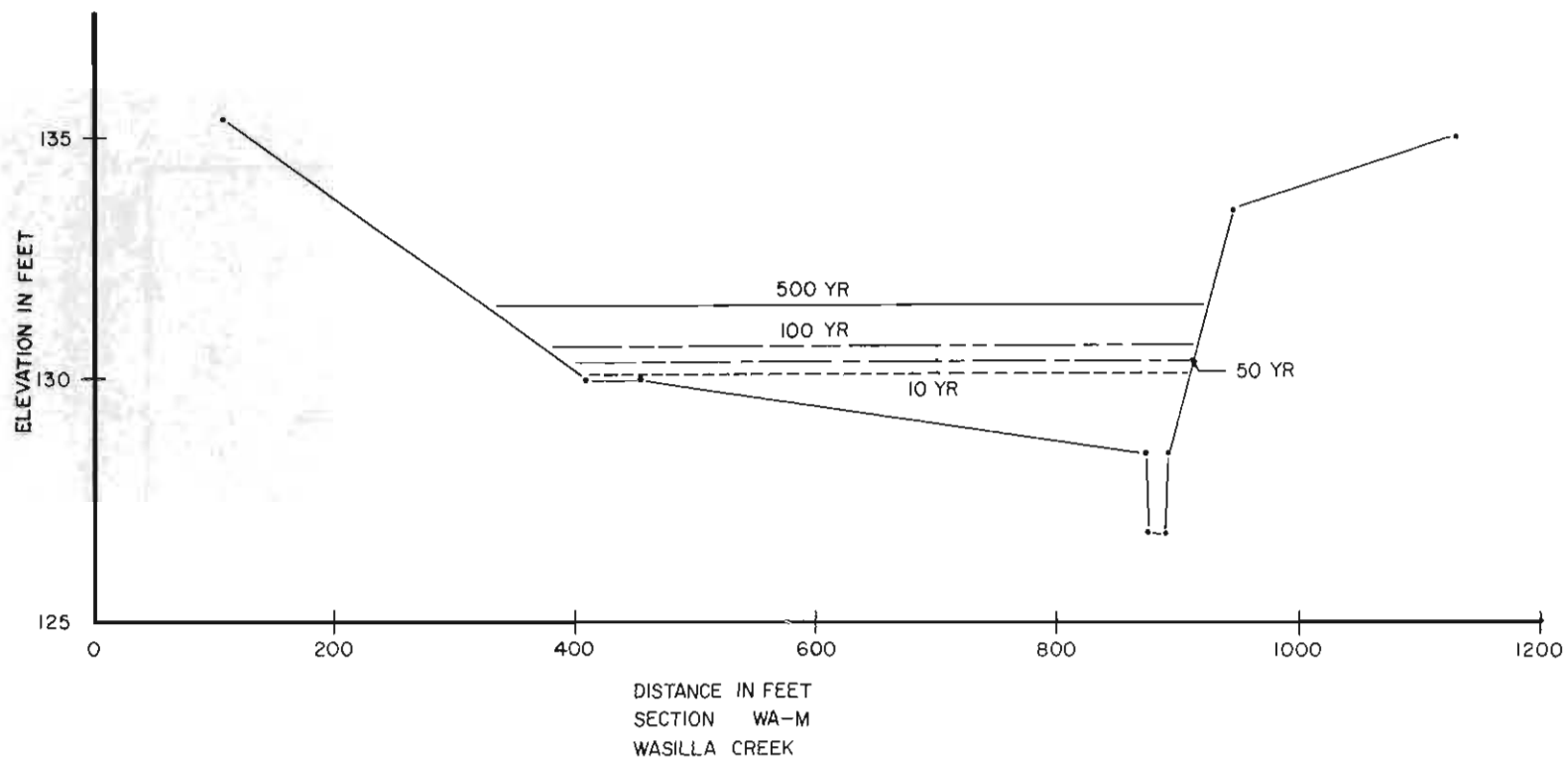

SOIL CONSERVATION SERVICE
U.S. DEPARTMENT OF AGRICULTURE
TALKEETNA SUBBASIN
MATANUSKA-SUSITNA BOROUGH, ALASKA

FIGURE 104

TYPICAL VALLEY SECTION
PRESENT CONDITIONS

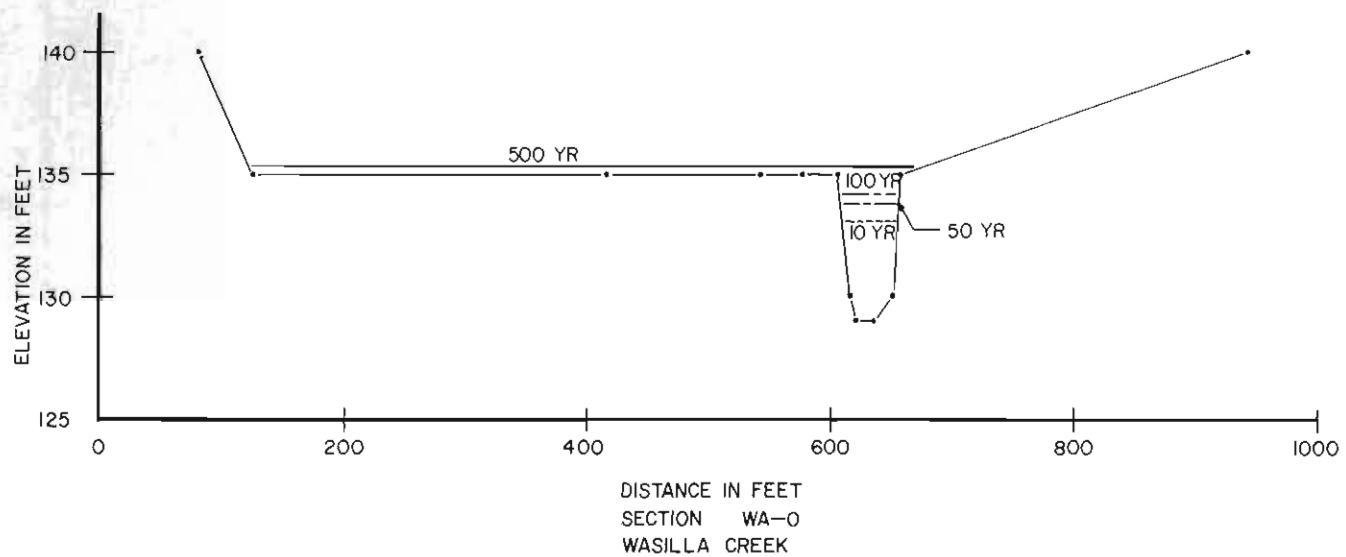

SOIL CONSERVATION SERVICE
U.S. DEPARTMENT OF AGRICULTURE
TALKEETNA SUBBASIN
MATANUSKA-SUSITNA BOROUGH, ALASKA

FIGURE 105

TYPICAL VALLEY SECTION
PRESENT CONDITIONS

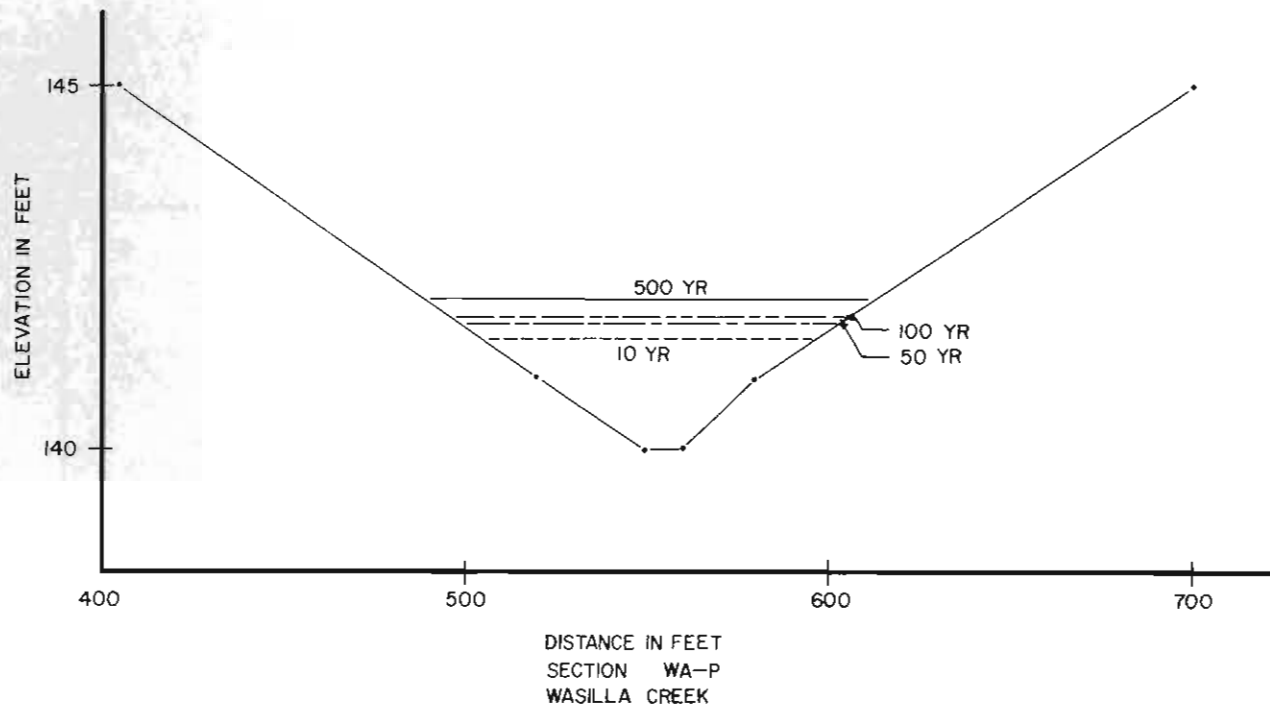

SOIL CONSERVATION SERVICE
U.S. DEPARTMENT OF AGRICULTURE
TALKEETNA SUBBASIN
MATANUSKA-SUSITNA BOROUGH, ALASKA

FIGURE 106

TYPICAL VALLEY SECTION
PRESENT CONDITIONS

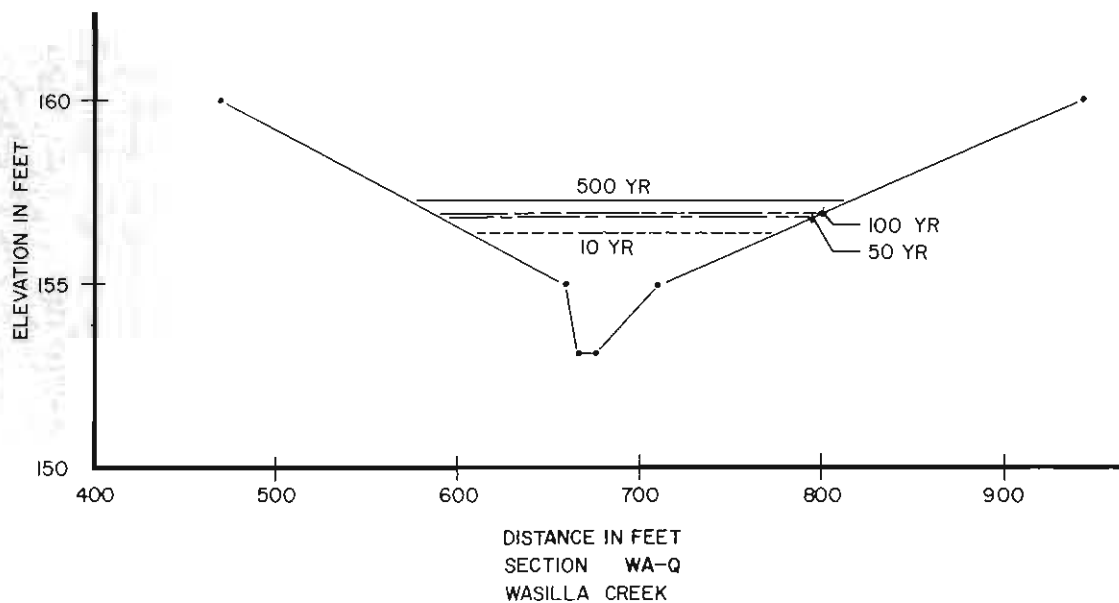

SOIL CONSERVATION SERVICE
U.S. DEPARTMENT OF AGRICULTURE
TALKEETNA SUBBASIN
MATANUSKA-SUSITNA BOROUGH, ALASKA

FIGURE 107

TYPICAL VALLEY SECTION
PRESENT CONDITIONS

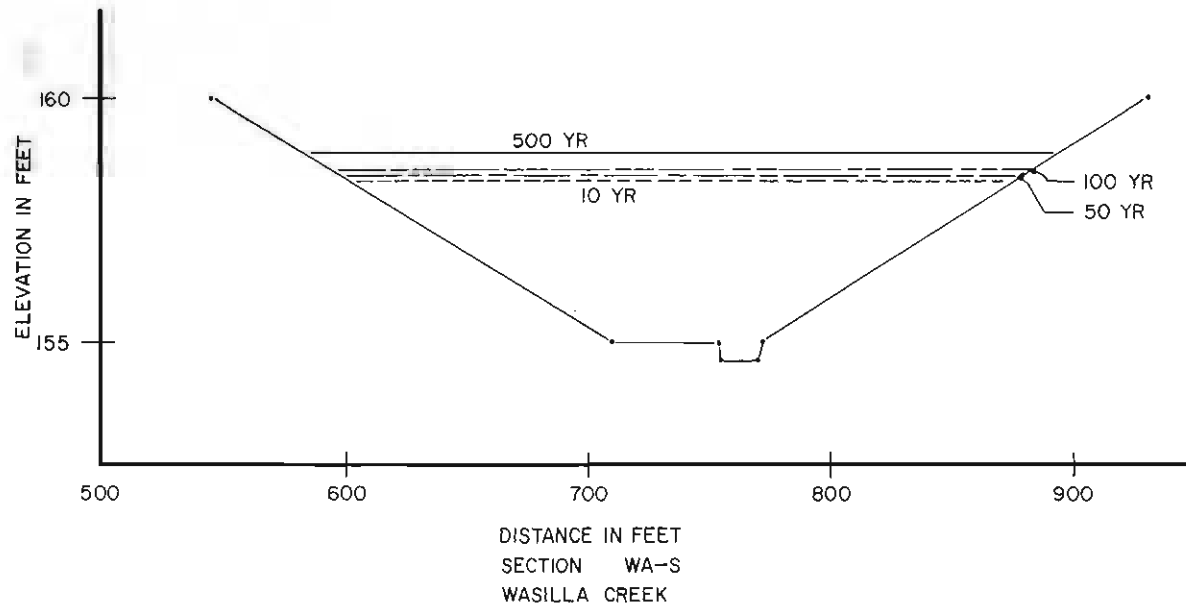

SOIL CONSERVATION SERVICE
U.S. DEPARTMENT OF AGRICULTURE
TALKEETNA SUBBASIN
MATANUSKA-SUSITNA BOROUGH, ALASKA

FIGURE 108

TYPICAL VALLEY SECTION
PRESENT CONDITIONS

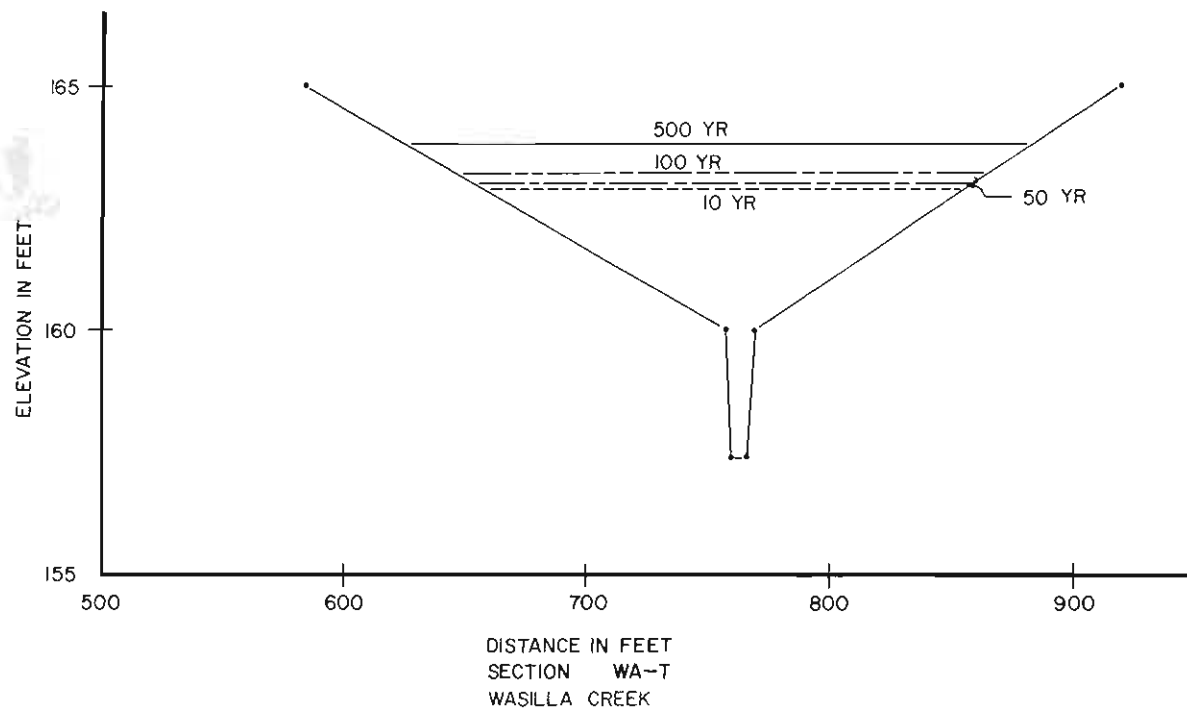

SOIL CONSERVATION SERVICE
U.S. DEPARTMENT OF AGRICULTURE
TALKEETNA SUBBASIN
MATANUSKA-SUSITNA BOROUGH, ALASKA

FIGURE 109

TYPICAL VALLEY SECTION
PRESENT CONDITIONS

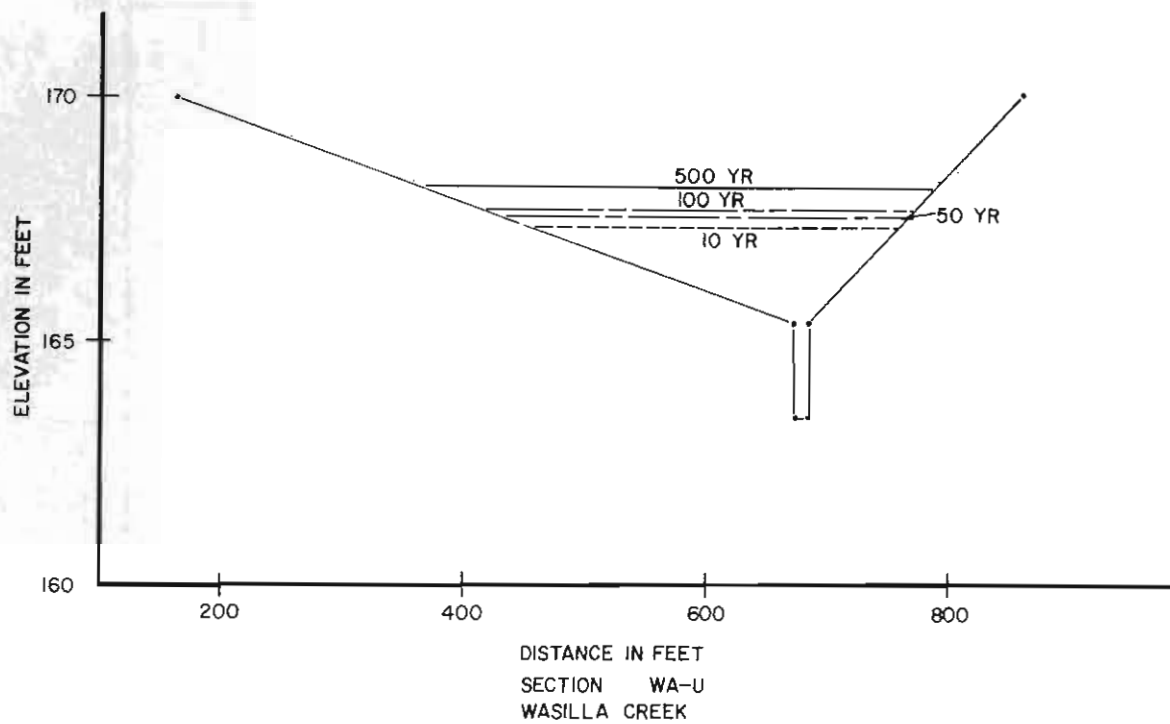

SOIL CONSERVATION SERVICE
U.S. DEPARTMENT OF AGRICULTURE
TALKEETNA SUBBASIN
MATANUSKA-SUSITNA BOROUGH, ALASKA

FIGURE 110

TYPICAL VALLEY SECTION
PRESENT CONDITIONS

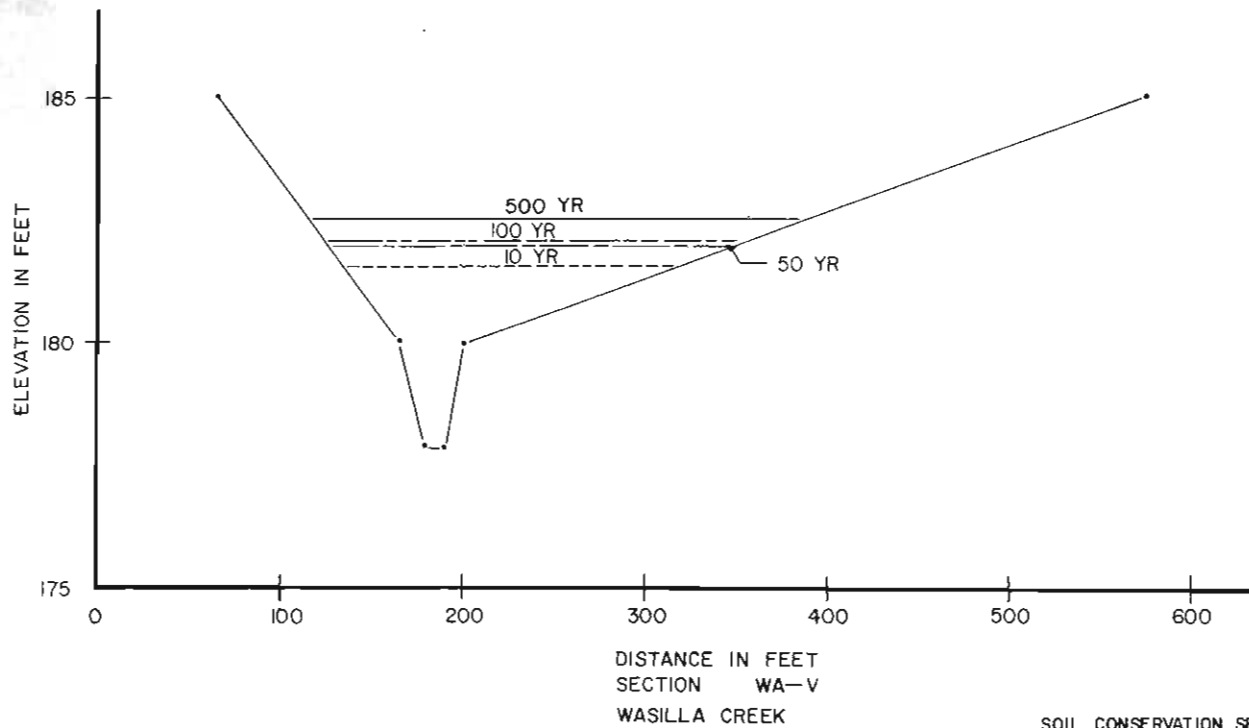

SOIL CONSERVATION SERVICE
U.S. DEPARTMENT OF AGRICULTURE
TALKEETNA SUBBASIN
MATANUSKA-SUSITNA BOROUGH, ALASKA

FIGURE 111

TYPICAL VALLEY SECTION
PRESENT CONDITIONS

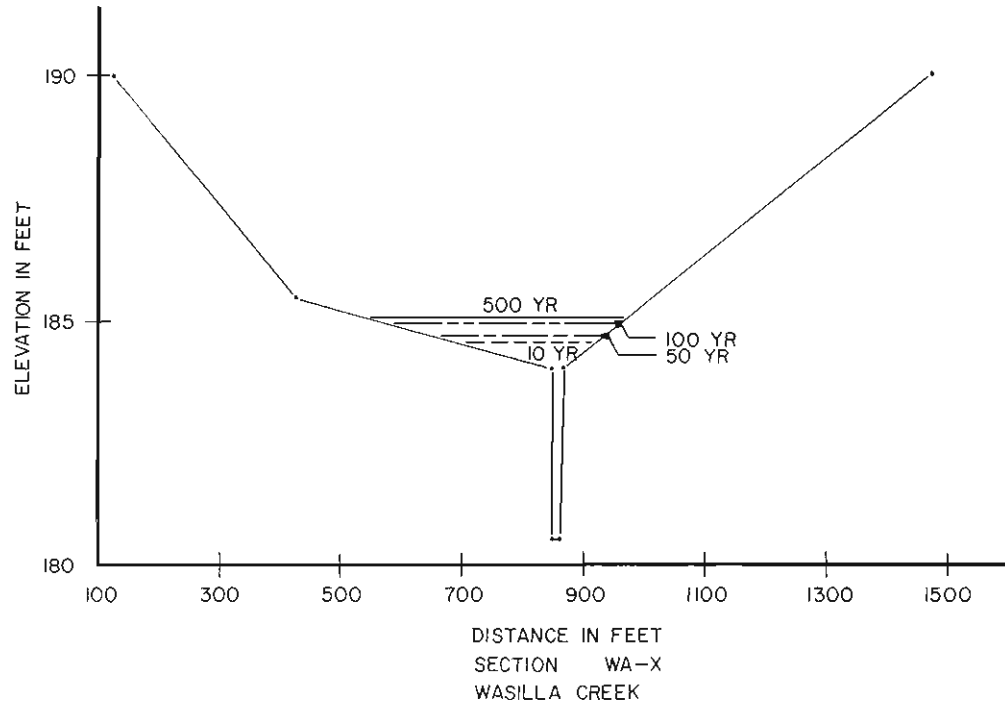

SOIL CONSERVATION SERVICE
U.S. DEPARTMENT OF AGRICULTURE
TALKEETNA SUBBASIN
MATANUSKA-SUSITNA BOROUGH, ALASKA

FIGURE 112

TYPICAL VALLEY SECTION
PRESENT CONDITIONS

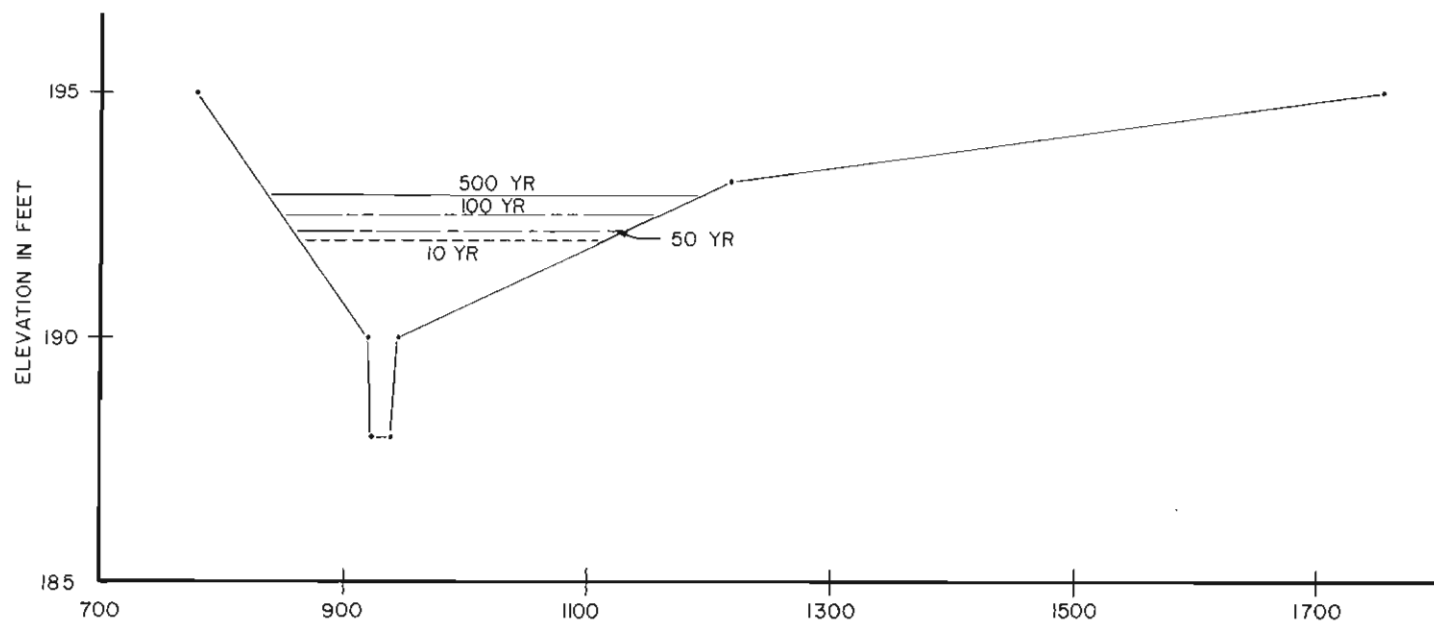

DISTANCE IN FEET
SECTION WA-Y
WASILLA CREEK

SOIL CONSERVATION SERVICE
U.S. DEPARTMENT OF AGRICULTURE
TALKEETNA SUBBASIN
MATANUSKA-SUSITNA BOROUGH, ALASKA

FIGURE 113

TYPICAL VALLEY SECTION
PRESENT CONDITIONS

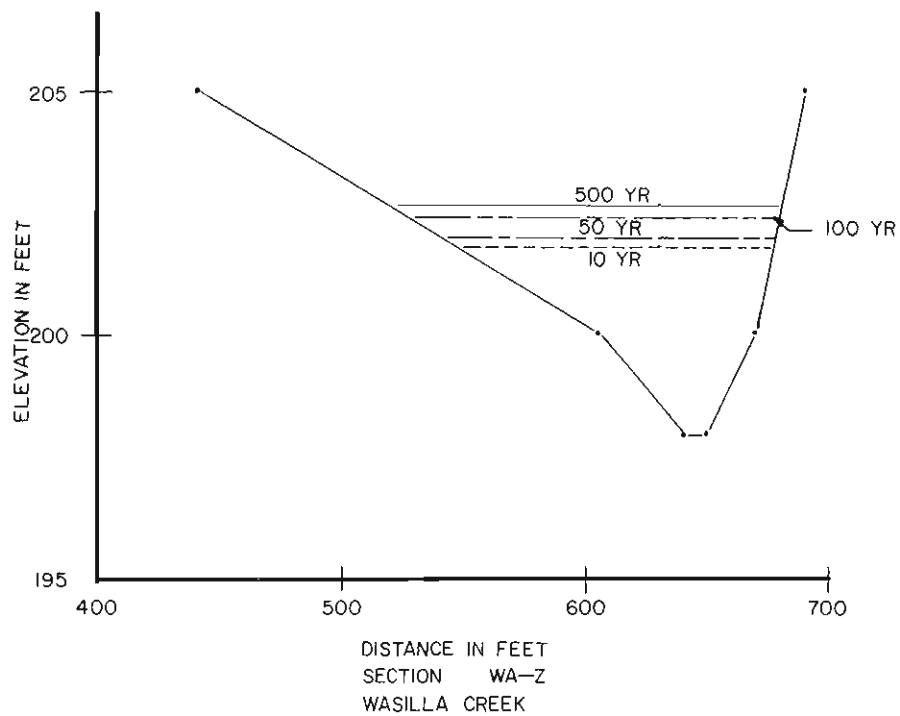

SOIL CONSERVATION SERVICE
U.S. DEPARTMENT OF AGRICULTURE
TALKEETNA SUBBASIN
MATANUSKA-SUSITNA BOROUGH, ALASKA

FIGURE 114

TYPICAL VALLEY SECTION
PRESENT CONDITIONS

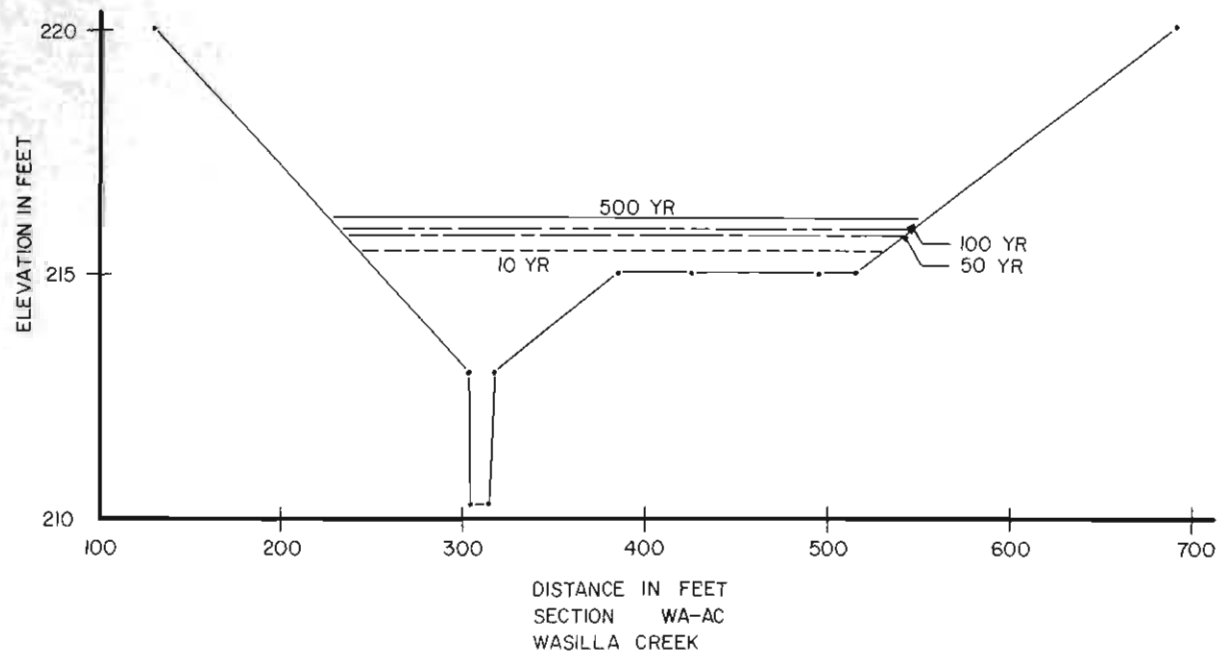

SOIL CONSERVATION SERVICE
U.S. DEPARTMENT OF AGRICULTURE
TALKEETNA SUBBASIN
MATANUSKA-SUSITNA BOROUGH, ALASKA

FIGURE 116

TYPICAL VALLEY SECTION
PRESENT CONDITIONS

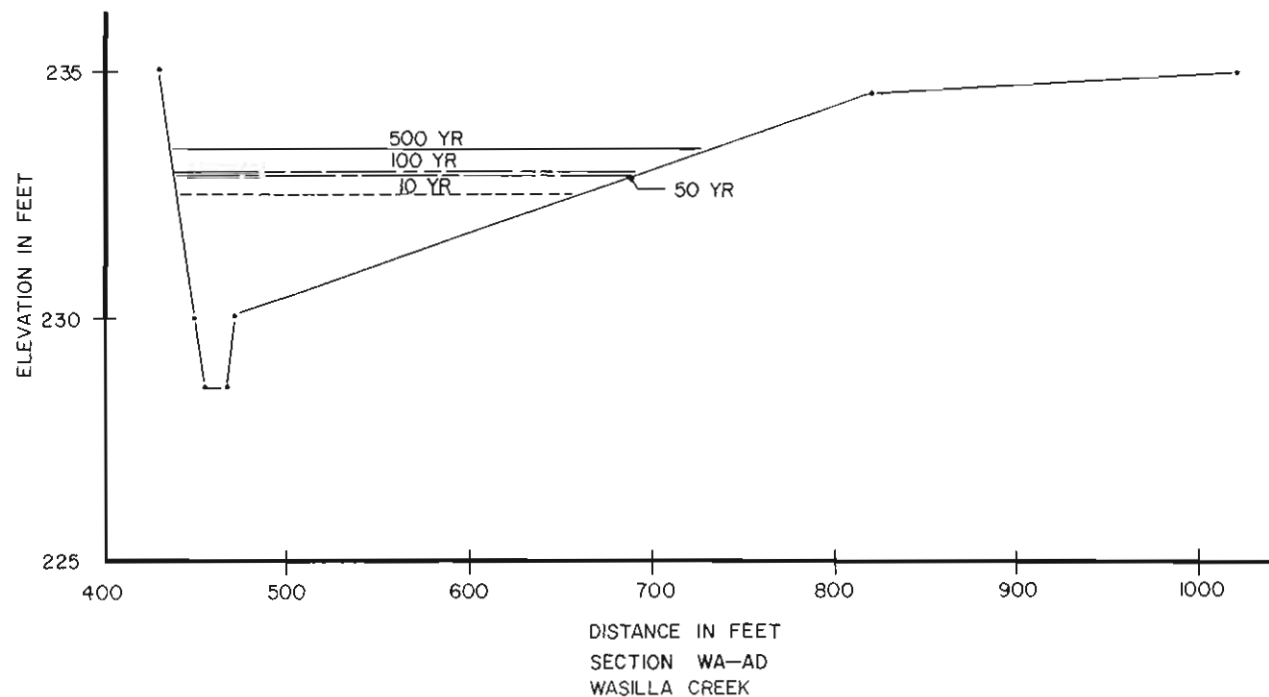

SOIL CONSERVATION SERVICE
U.S. DEPARTMENT OF AGRICULTURE
TALKEETNA SUBBASIN
MATANUSKA-SUSITNA BOROUGH, ALASKA

FIGURE 117

TYPICAL VALLEY SECTION
PRESENT CONDITIONS

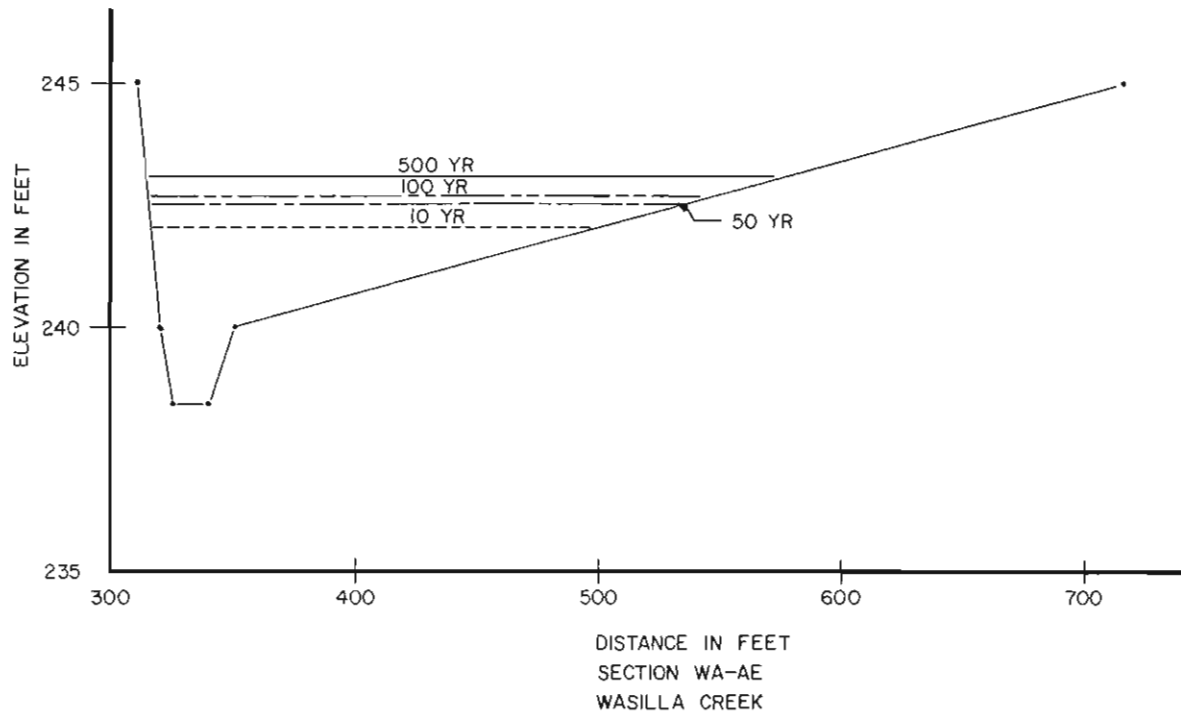

SOIL CONSERVATION SERVICE
U.S. DEPARTMENT OF AGRICULTURE
TALKEETNA SUBBASIN
MATANUSKA-SUSITNA BOROUGH, ALASKA

FIGURE 118

TYPICAL VALLEY SECTION
PRESENT CONDITIONS

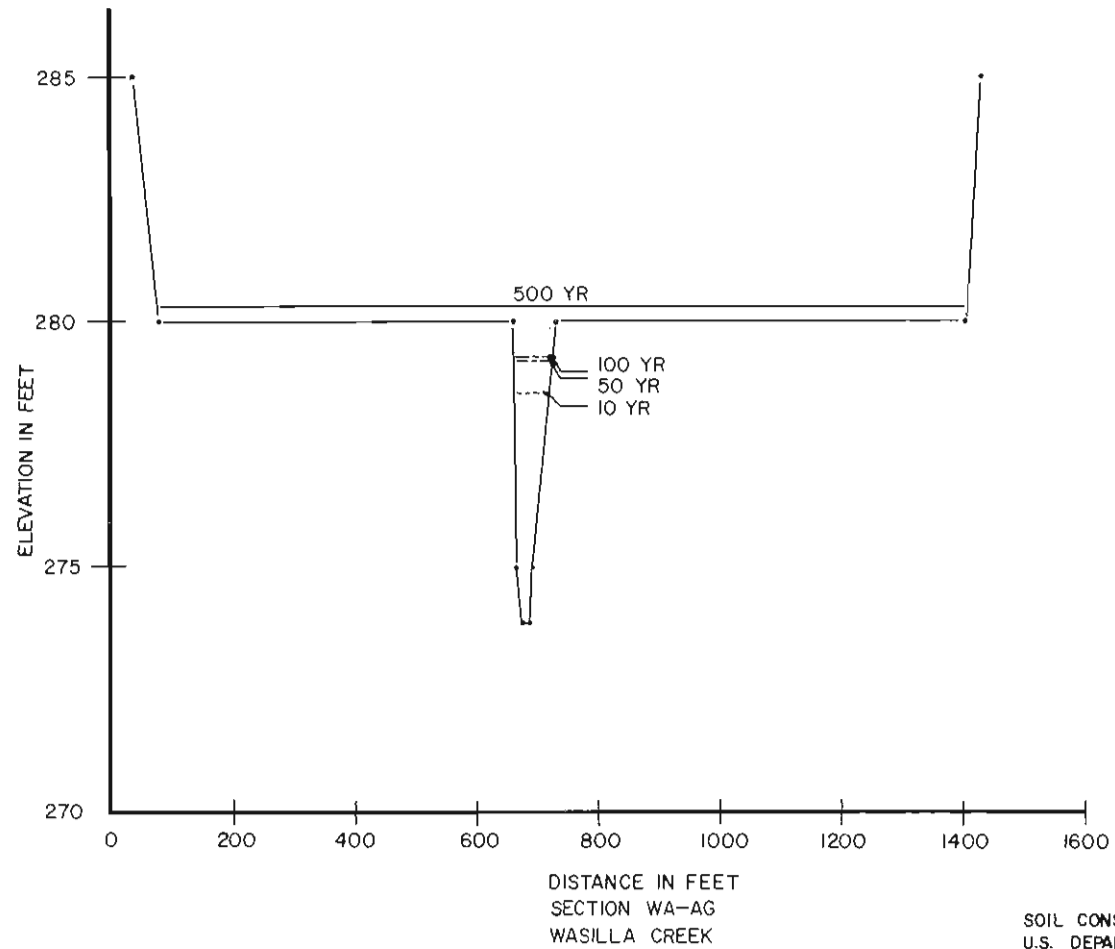

SOIL CONSERVATION SERVICE
U.S. DEPARTMENT OF AGRICULTURE
TALKEETNA SUBBASIN
MATANUSKA-SUSITNA BOROUGH, ALASKA

FIGURE 120

TYPICAL VALLEY SECTION
PRESENT CONDITIONS

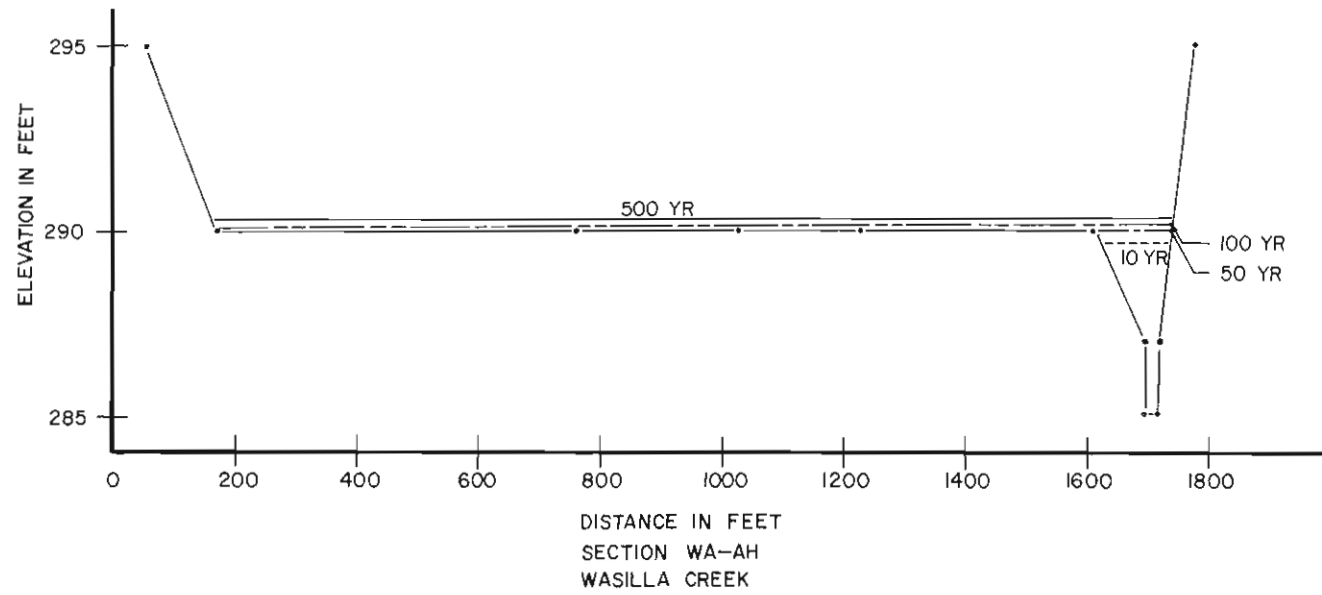

SOIL CONSERVATION SERVICE
U.S. DEPARTMENT OF AGRICULTURE
TALKEETNA SUBBASIN
MATANUSKA-SUSITNA BOROUGH, ALASKA

FIGURE 121

TYPICAL VALLEY SECTION
PRESENT CONDITIONS

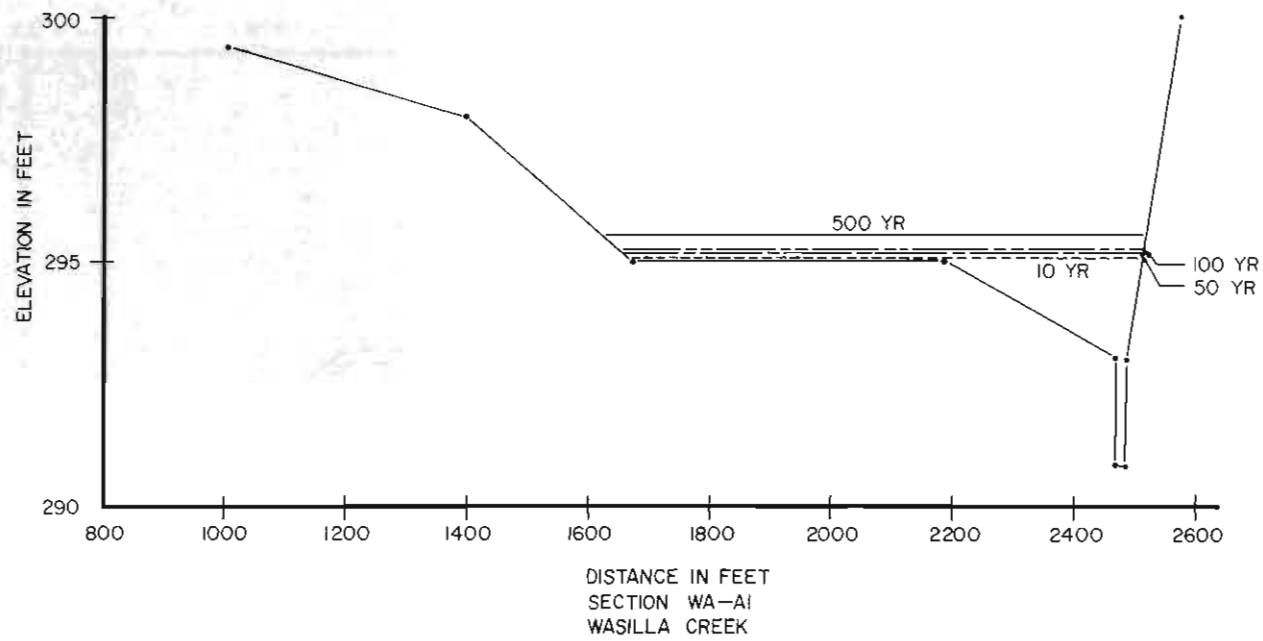

SOIL CONSERVATION SERVICE
U.S. DEPARTMENT OF AGRICULTURE
TALKEETNA SUBBASIN
MATANUSKA-SUSITNA BOROUGH, ALASKA

FIGURE 122

TYPICAL VALLEY SECTION
PRESENT CONDITIONS

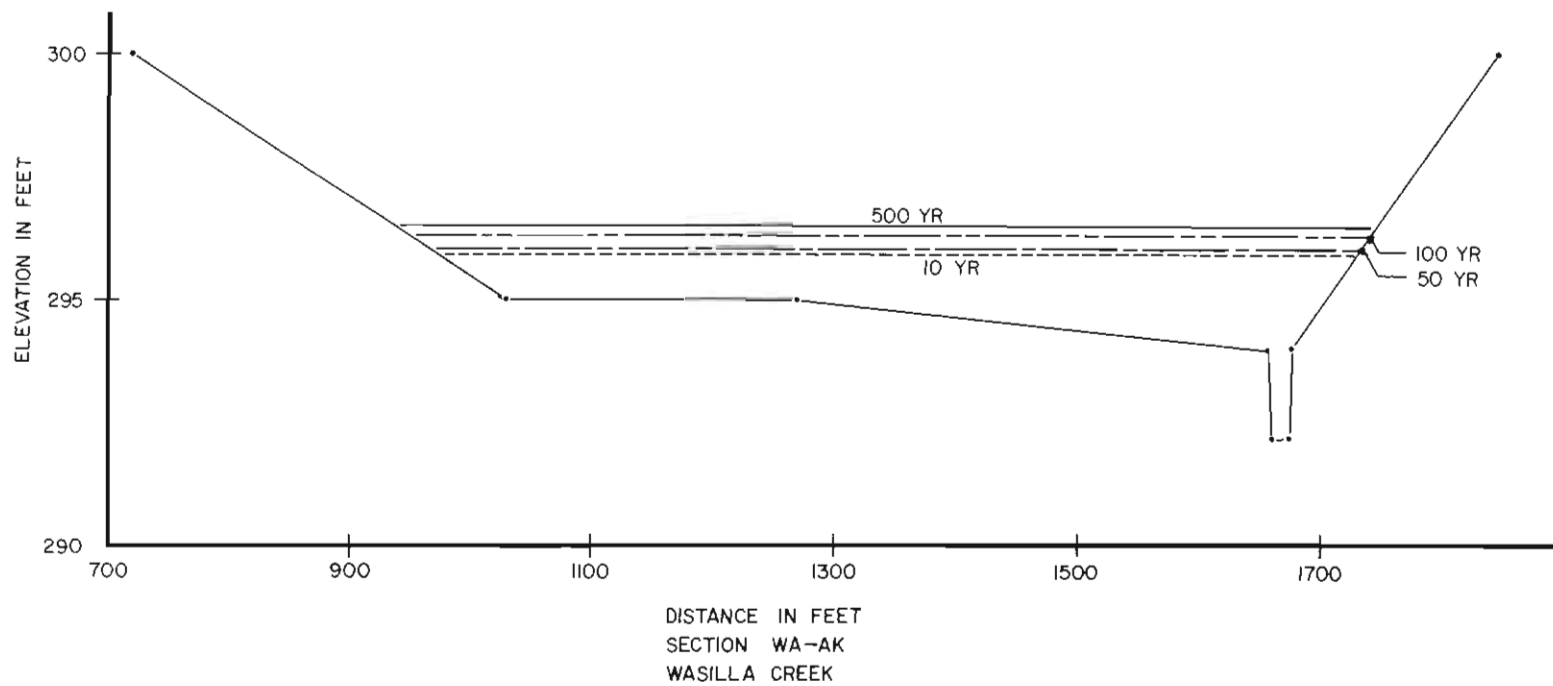

SOIL CONSERVATION SERVICE
U.S. DEPARTMENT OF AGRICULTURE
TALKEETNA SUBBASIN
MATANUSKA-SUSITNA BOROUGH, ALASKA

FIGURE 123

TYPICAL VALLEY SECTION
PRESENT CONDITIONS

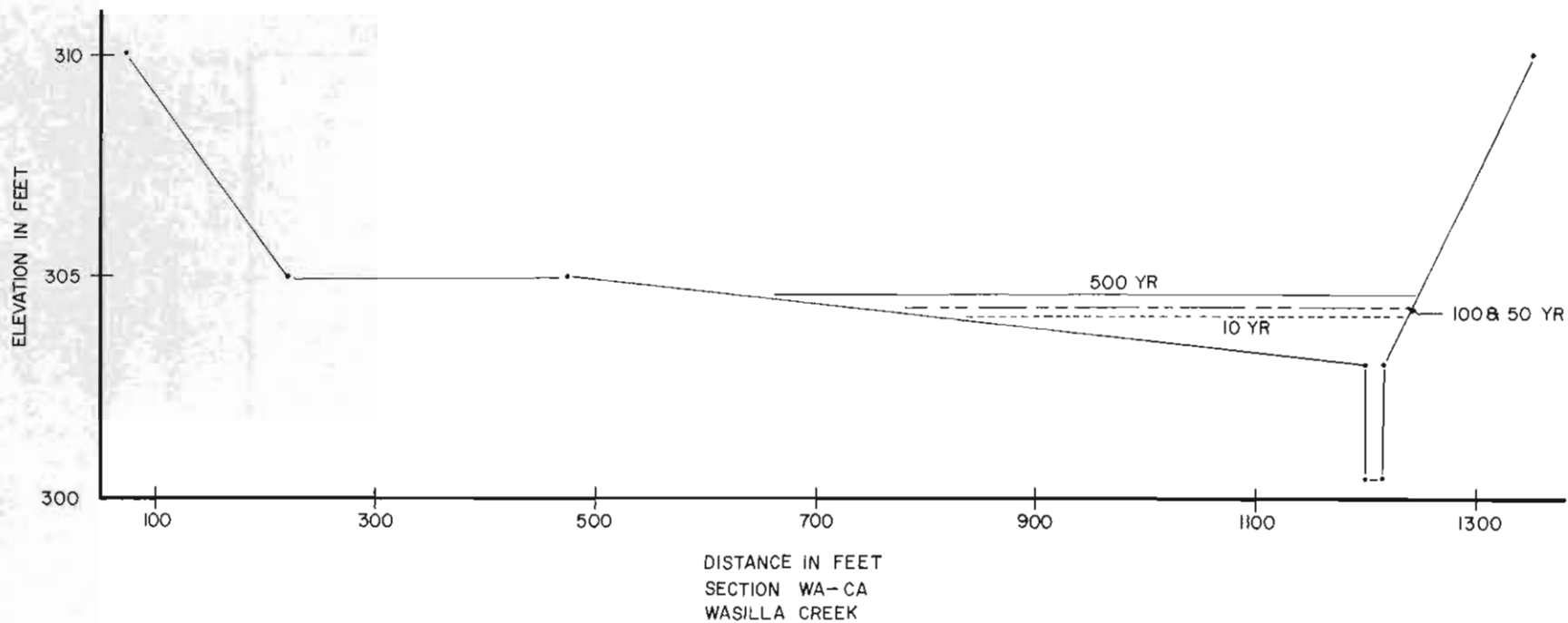

SOIL CONSERVATION SERVICE
U.S. DEPARTMENT OF AGRICULTURE
TALKEETNA SUBBASIN
MATANUSKA-SUSITNA BOROUGH, ALASKA

FIGURE 124

TYPICAL VALLEY SECTION
PRESENT CONDITIONS

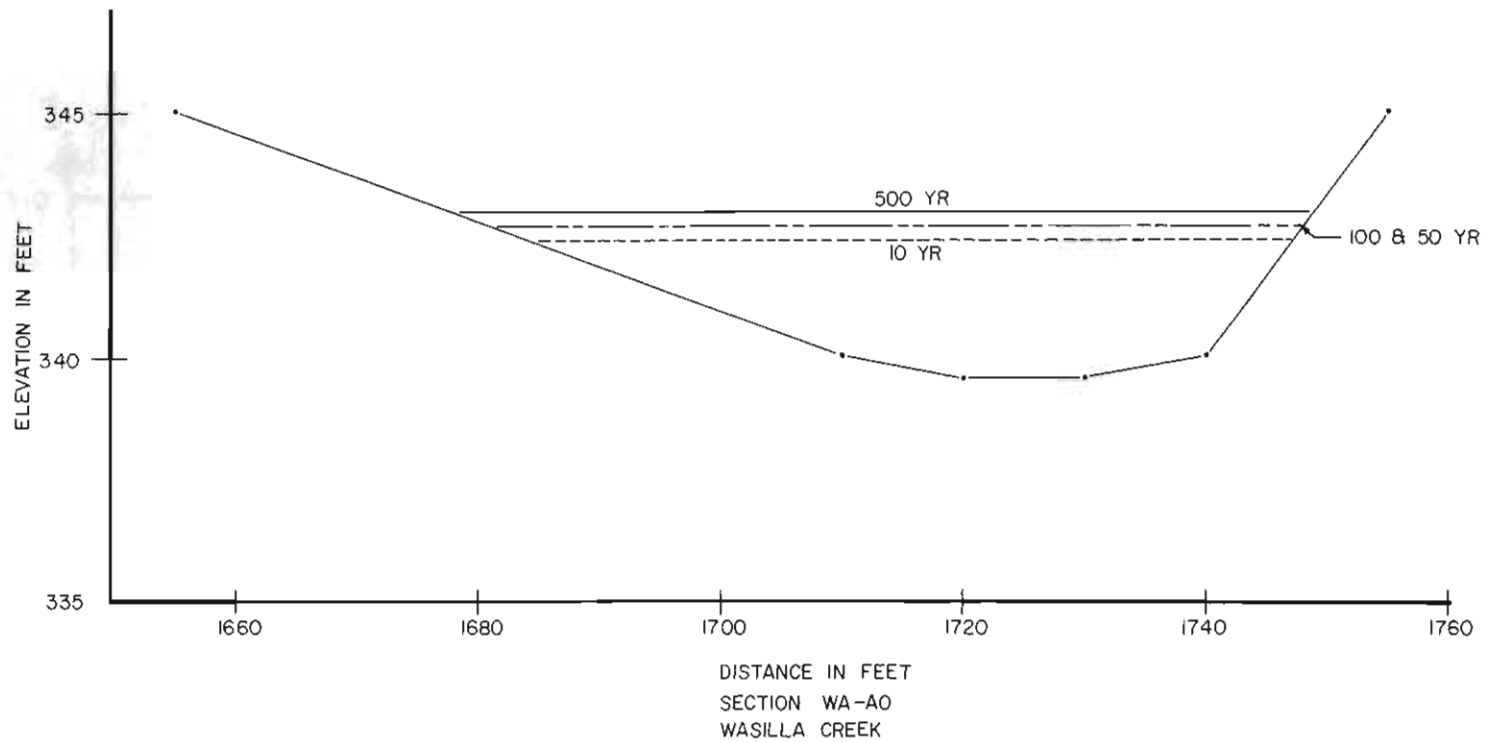

SOIL CONSERVATION SERVICE
U.S. DEPARTMENT OF AGRICULTURE
TALKEETNA SUBBASIN
MATANUSKA-SUSITNA BOROUGH, ALASKA

FIGURE 126

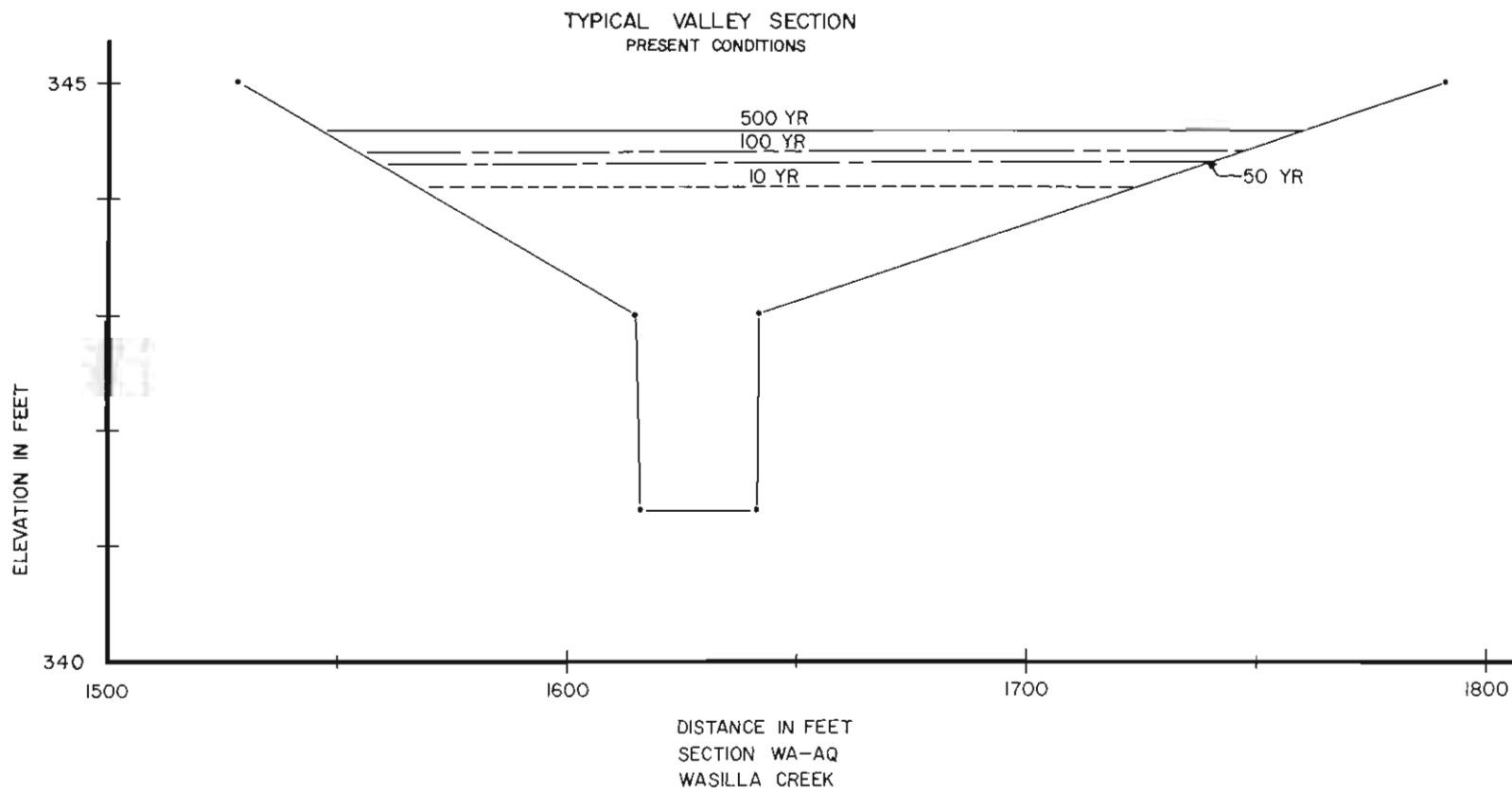

SOIL CONSERVATION SERVICE
U.S. DEPARTMENT OF AGRICULTURE
TALKEETNA SUBBASIN
MATANUSKA-SUSITNA BOROUGH, ALASKA

FIGURE 127

TYPICAL VALLEY SECTION
PRESENT CONDITIONS

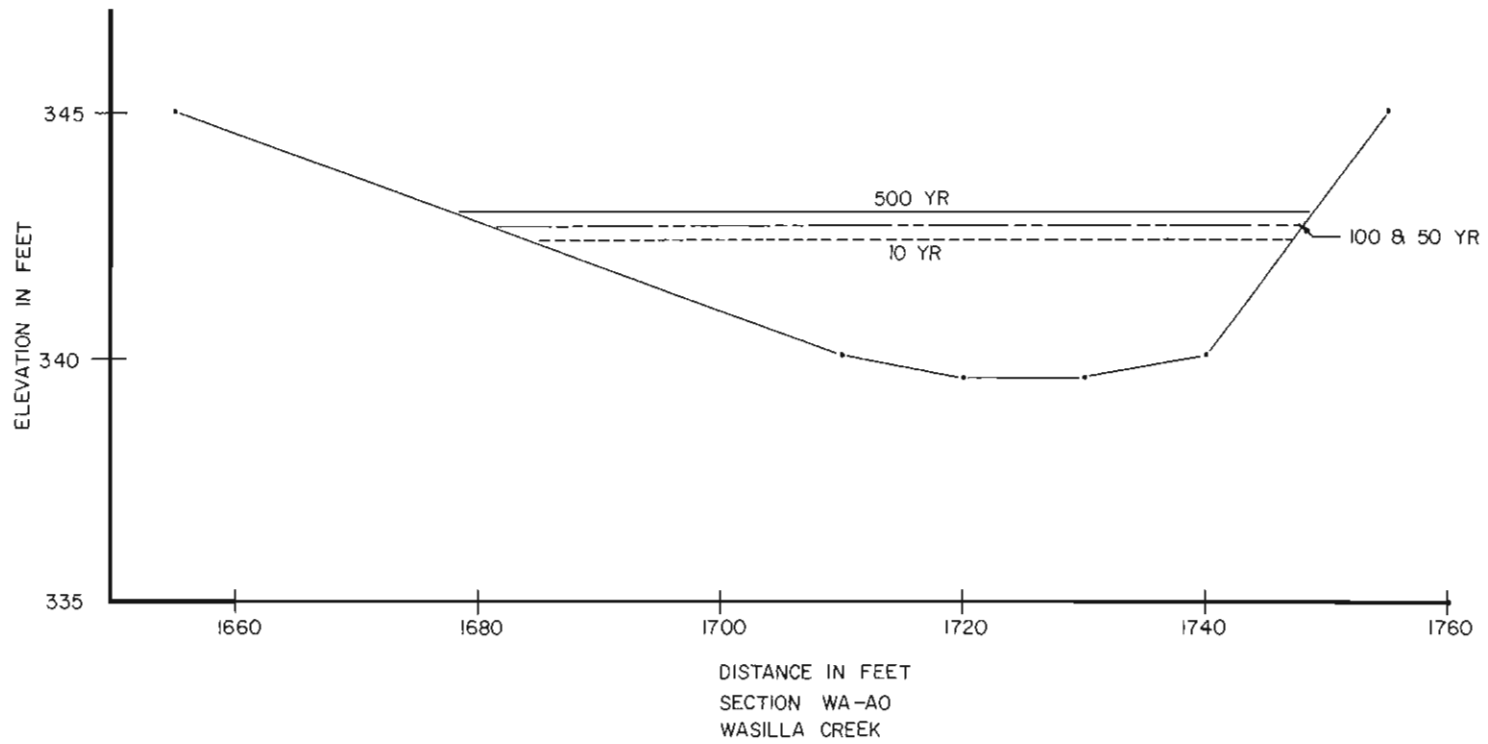

SOIL CONSERVATION SERVICE
U.S. DEPARTMENT OF AGRICULTURE
TALKEETNA SUBBASIN
MATANUSKA-SUSITNA BOROUGH, ALASKA

FIGURE 126

TYPICAL VALLEY SECTION
PRESENT CONDITIONS

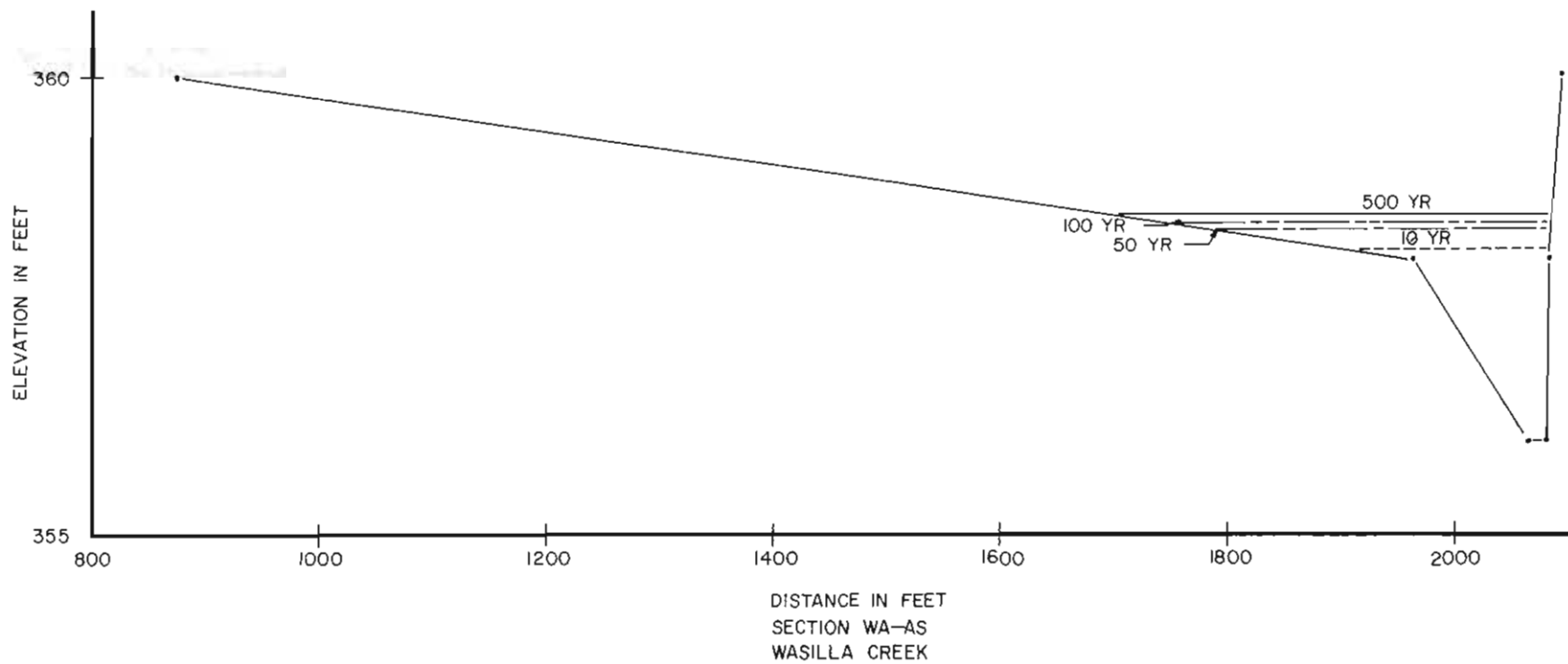

SOIL CONSERVATION SERVICE
U.S. DEPARTMENT OF AGRICULTURE
TALKEETNA SUBBASIN
MATANUSKA-SUSITNA BOROUGH, ALASKA

FIGURE 129

TYPICAL VALLEY SECTION
PRESENT CONDITIONS

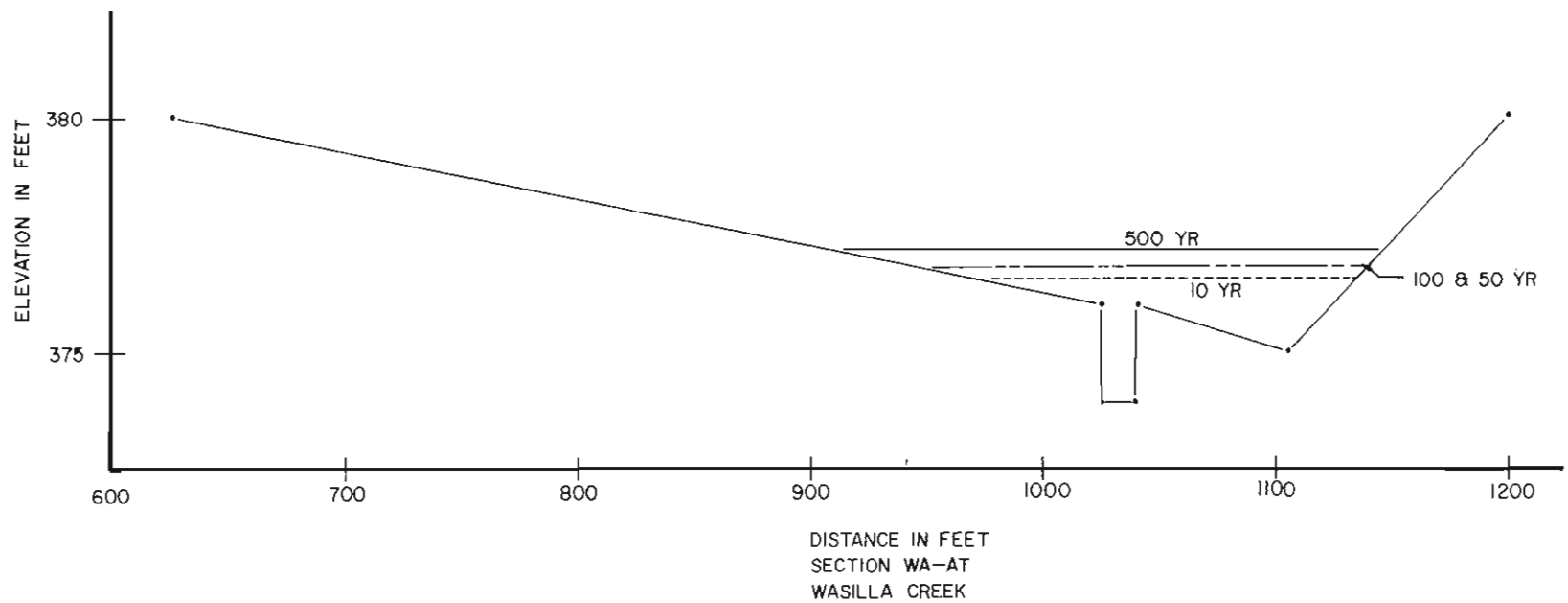

SOIL CONSERVATION SERVICE
U S DEPARTMENT OF AGRICULTURE
TALKEETNA SUBBASIN
MATANUSKA-SUSITNA BOROUGH, ALASKA

FIGURE 130

TYPICAL VALLEY SECTION
PRESENT CONDITIONS

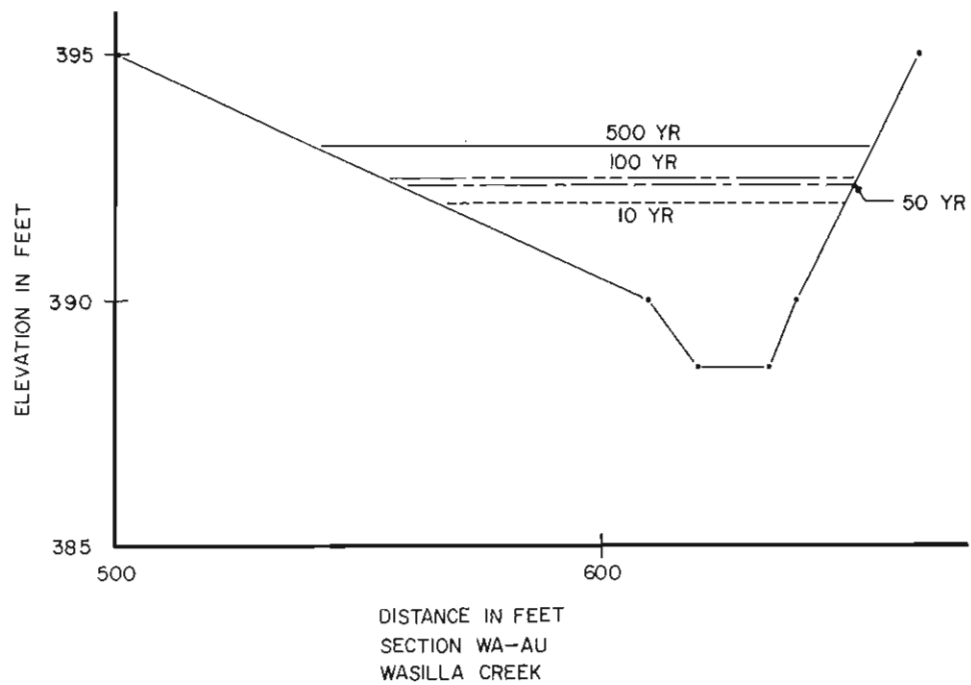

SOIL CONSERVATION SERVICE
U S DEPARTMENT OF AGRICULTURE
TALKEETNA SUBBASIN
MATANUSKA-SUSITNA BOROUGH, ALASKA

FIGURE 131

TYPICAL VALLEY SECTION
PRESENT CONDITIONS

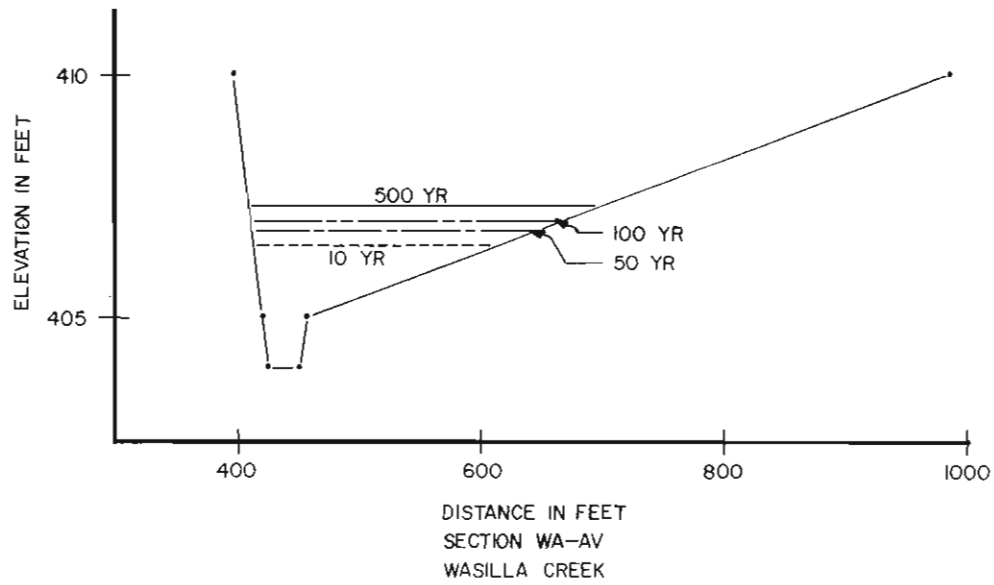

SOIL CONSERVATION SERVICE
U S DEPARTMENT OF AGRICULTURE
TALKEETNA SUBBASIN
MATANUSKA-SUSITNA BOROUGH, ALASKA

FIGURE 132

TYPICAL VALLEY SECTION
PRESENT CONDITIONS

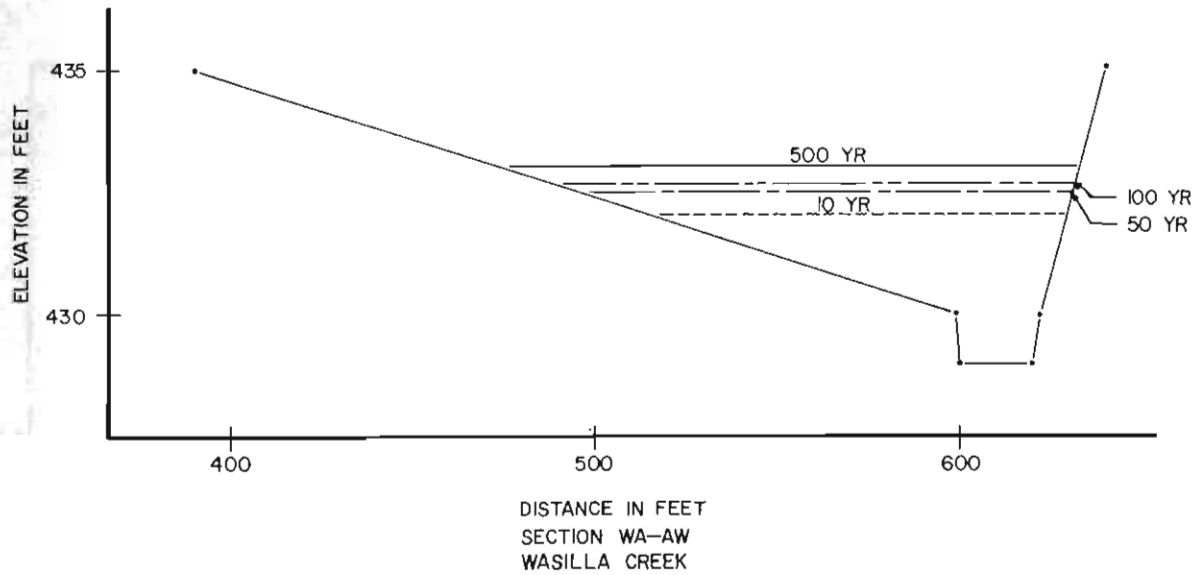

SOIL CONSERVATION SERVICE
U S DEPARTMENT OF AGRICULTURE
TALKEETNA SUBBASIN
MATANUSKA-SUSITNA BOROUGH, ALASKA

FIGURE 133

TYPICAL VALLEY SECTION
PRESENT CONDITIONS

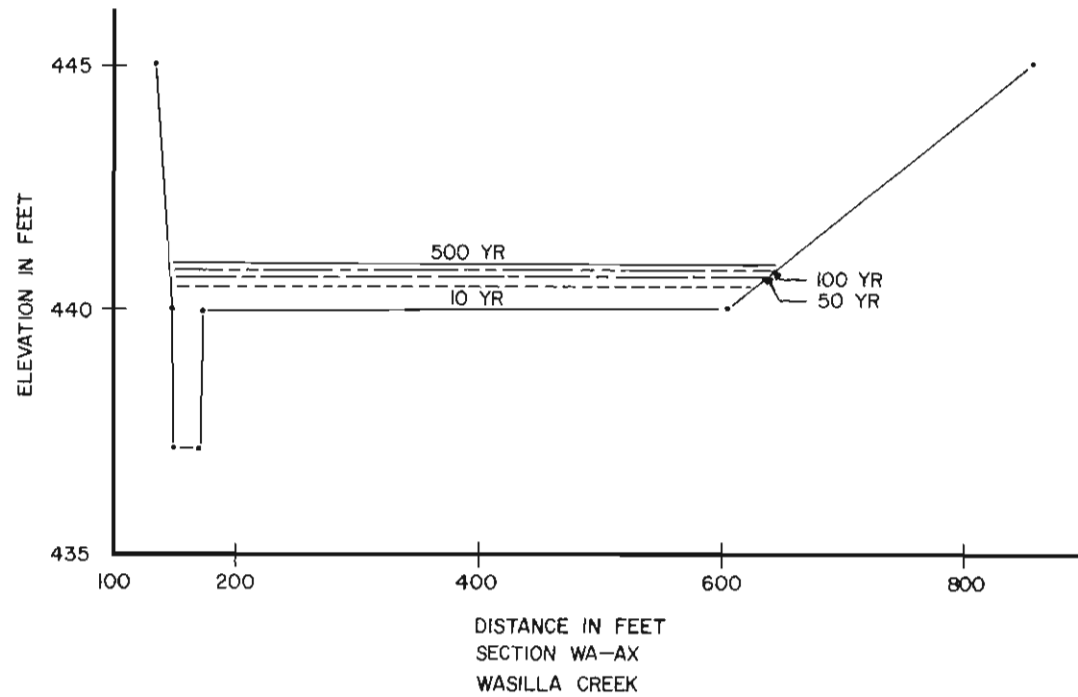

SOIL CONSERVATION SERVICE
U S DEPARTMENT OF AGRICULTURE
TALKEETNA SUBBASIN
MATANUSKA-SUSITNA BOROUGH, ALASKA

FIGURE 134

TYPICAL VALLEY SECTION
PRESENT CONDITIONS

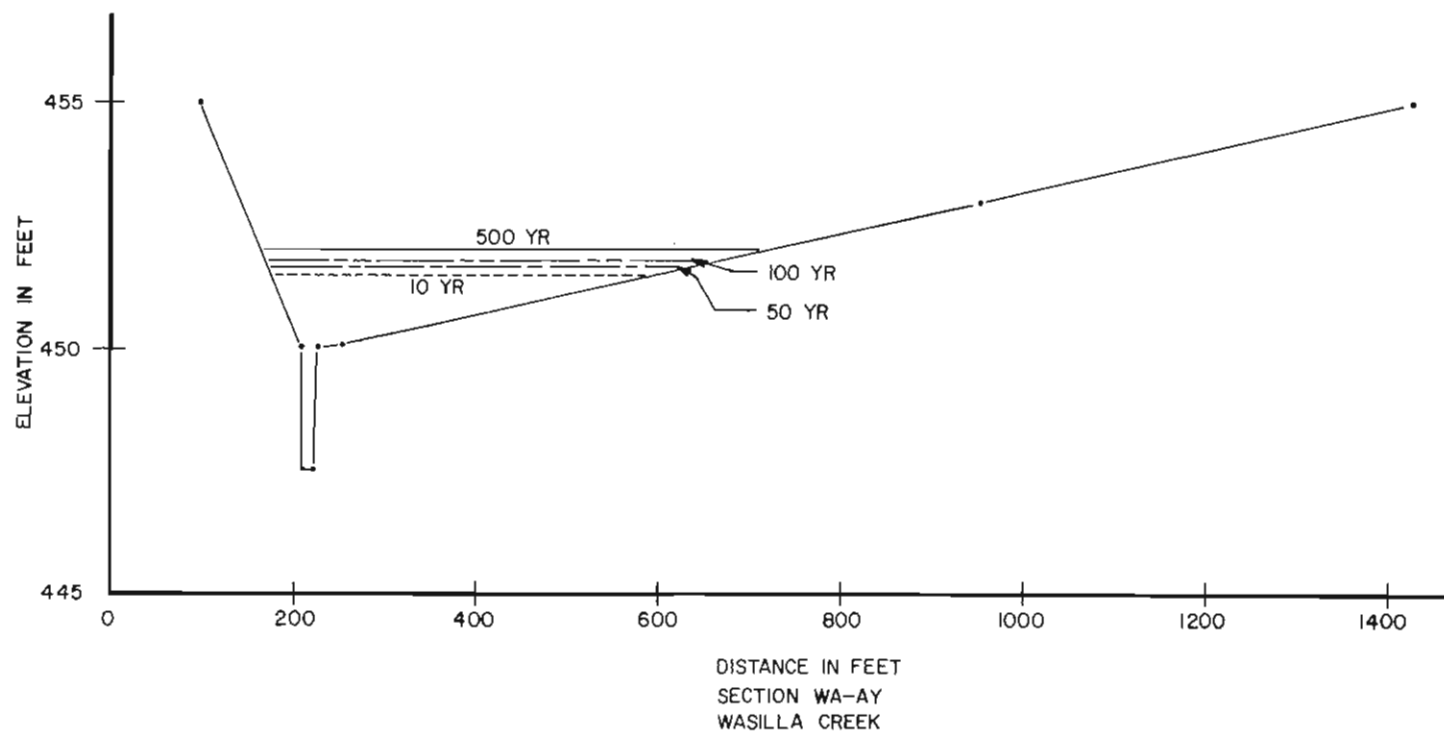

SOIL CONSERVATION SERVICE
U S DEPARTMENT OF AGRICULTURE
TALKEETNA SUBBASIN
MATANUSKA-SUSITNA BOROUGH, ALASKA

FIGURE 135

TYPICAL VALLEY SECTION
PRESENT CONDITIONS

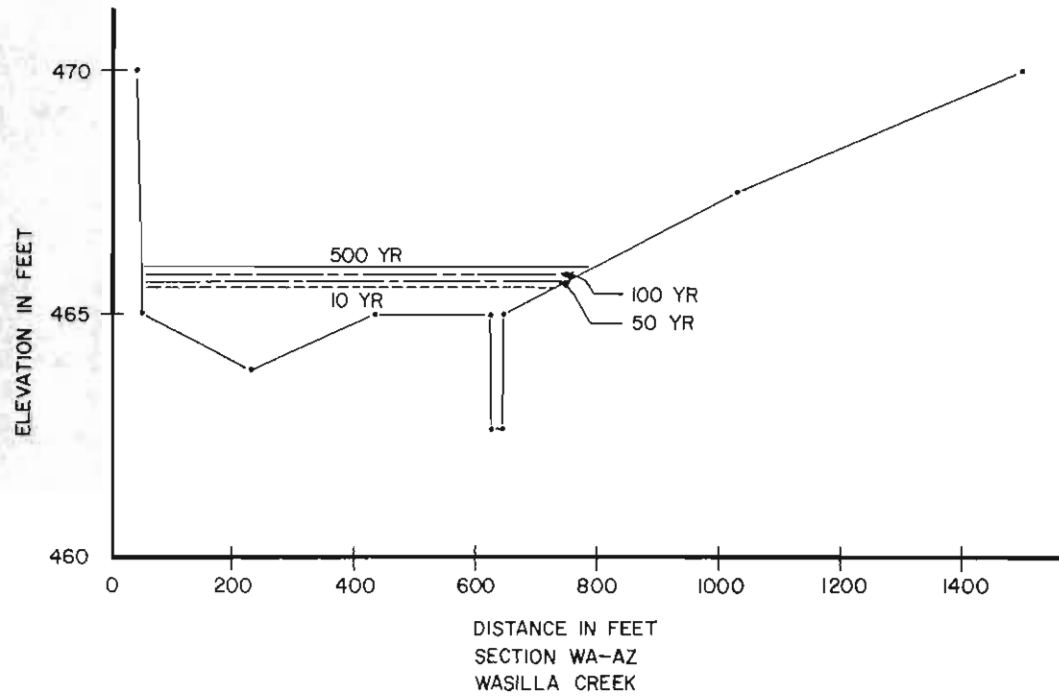

SOIL CONSERVATION SERVICE
U.S. DEPARTMENT OF AGRICULTURE
TALKEETNA SUBBASIN
MATANUSKA-SUSITNA BOROUGH, ALASKA

FIGURE 136

TYPICAL VALLEY SECTION
PRESENT CONDITIONS

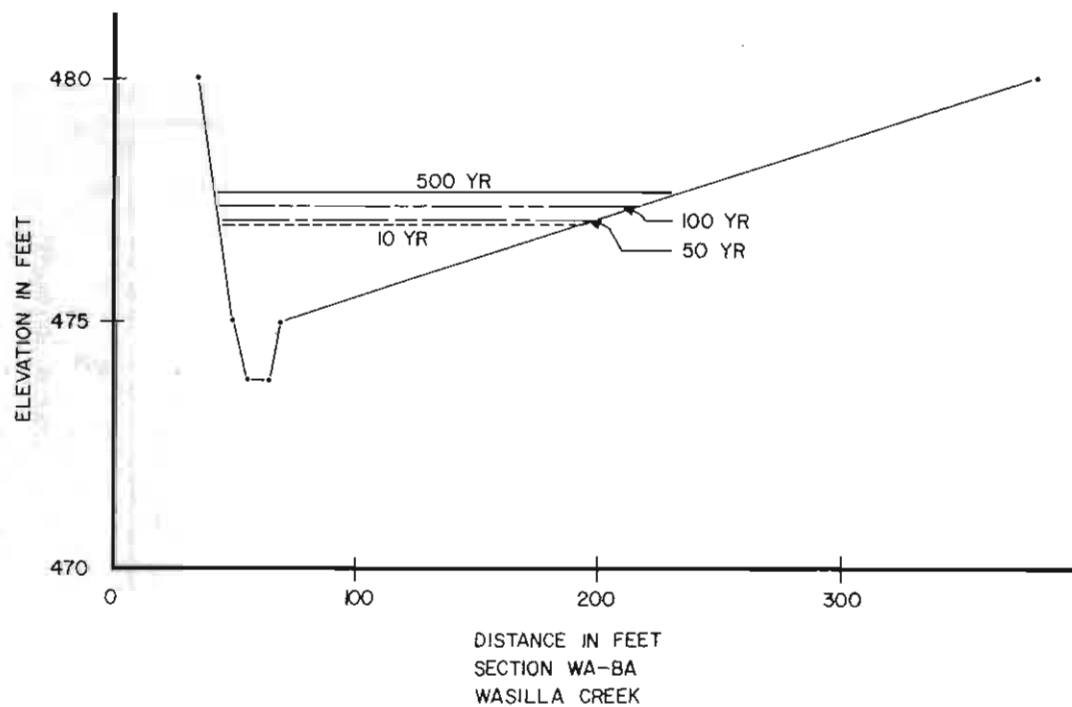

SOIL CONSERVATION SERVICE
U.S. DEPARTMENT OF AGRICULTURE
TALKEETNA SUBBASIN
MATANUSKA-SUSITNA BOROUGH, ALASKA

FIGURE 137

TYPICAL VALLEY SECTION
PRESENT CONDITIONS

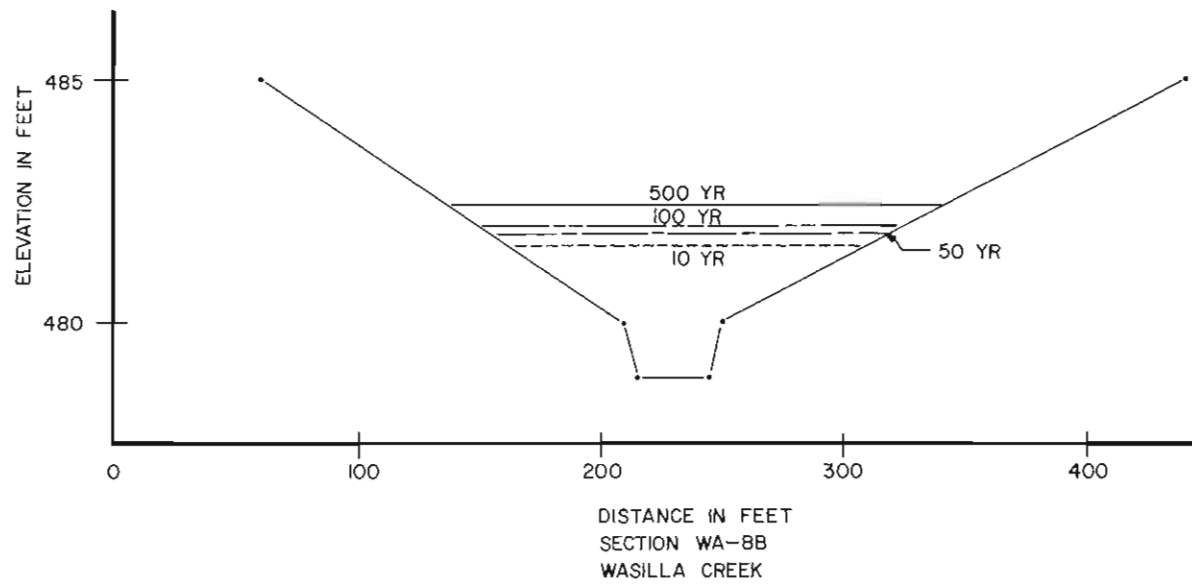

SOIL CONSERVATION SERVICE
U.S. DEPARTMENT OF AGRICULTURE
TALKEETNA SUBBASIN
MATANUSKA-SUSITNA BOROUGH, ALASKA

FIGURE 138

TYPICAL VALLEY SECTION
PRESENT CONDITIONS

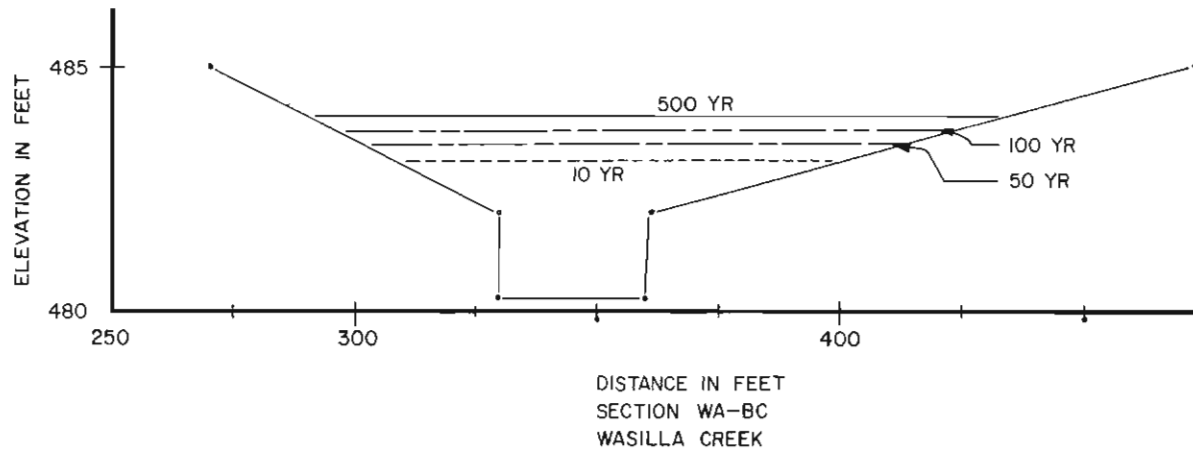

SOIL CONSERVATION SERVICE
U.S. DEPARTMENT OF AGRICULTURE
TALKEETNA SUBBASIN
MATANUSKA-SUSITNA BOROUGH, ALASKA

FIGURE 139

TYPICAL VALLEY SECTION
PRESENT CONDITIONS

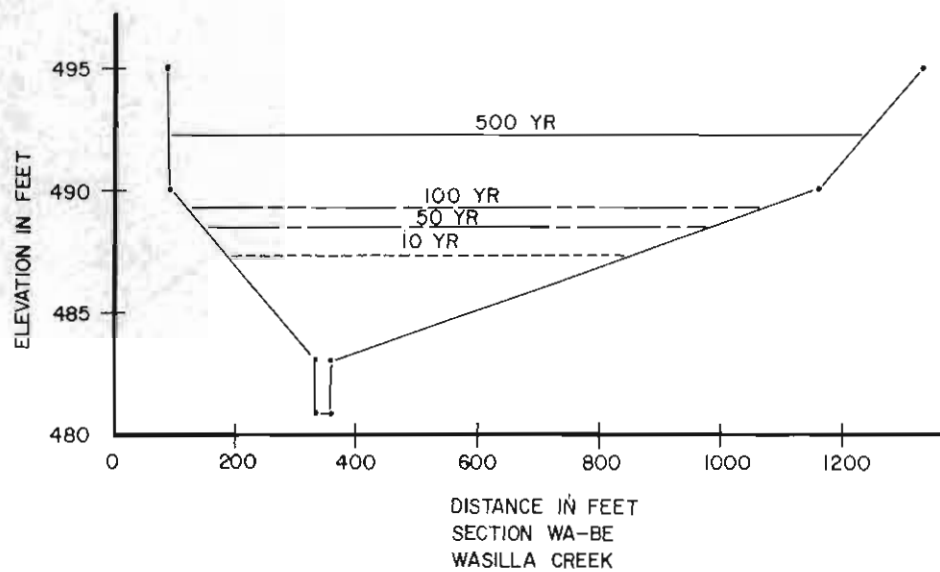

SOIL CONSERVATION SERVICE
U.S. DEPARTMENT OF AGRICULTURE
TALKEETNA SUBBASIN
MATANUSKA-SUSITNA BOROUGH, ALASKA

FIGURE 140

TYPICAL VALLEY SECTION
PRESENT CONDITIONS

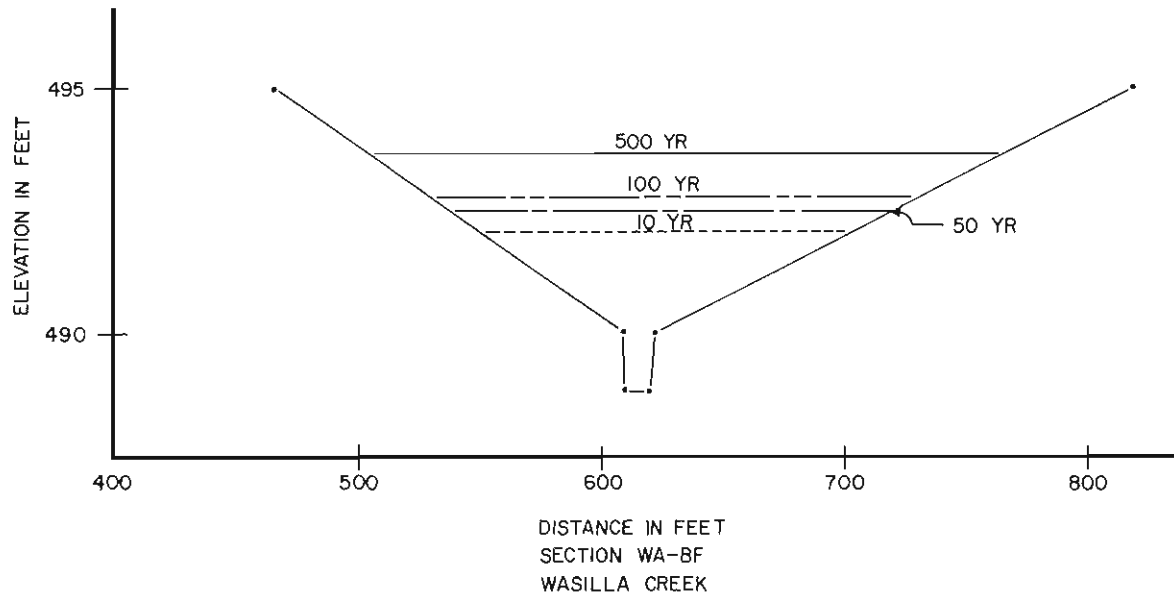

SOIL CONSERVATION SERVICE
U.S. DEPARTMENT OF AGRICULTURE
TALKEETNA SUBBASIN
MATANUSKA-SUSITNA BOROUGH, ALASKA

FIGURE 141

TYPICAL VALLEY SECTION
PRESENT CONDITIONS

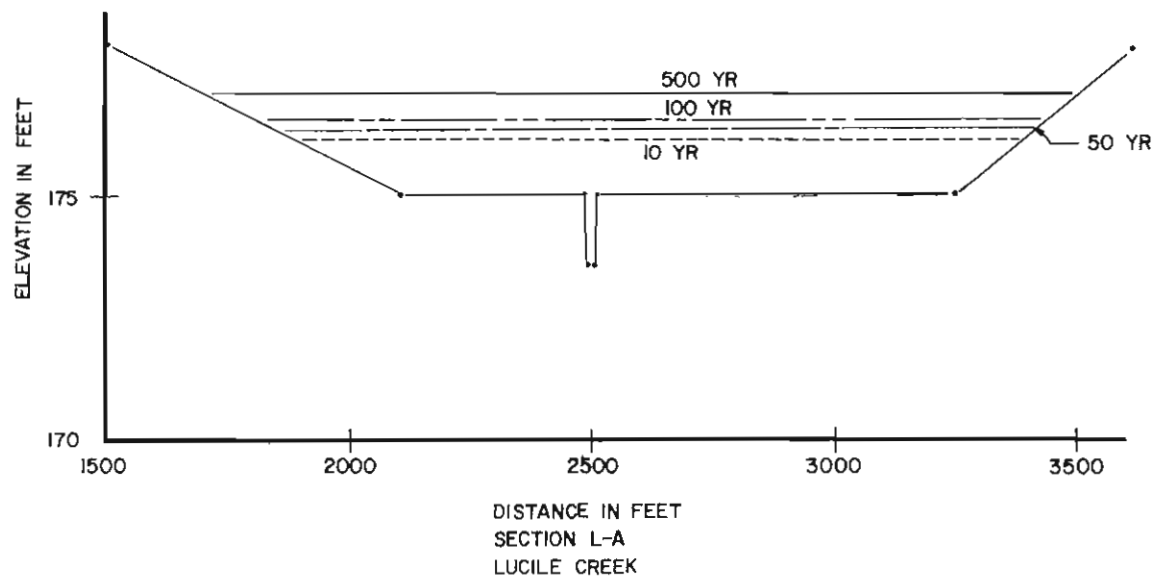

SOIL CONSERVATION SERVICE
U.S. DEPARTMENT OF AGRICULTURE
TALKEETNA SUBBASIN
MATANUSKA-SUSITNA BOROUGH, ALASKA

FIGURE 142

TYPICAL VALLEY SECTION
PRESENT CONDITIONS

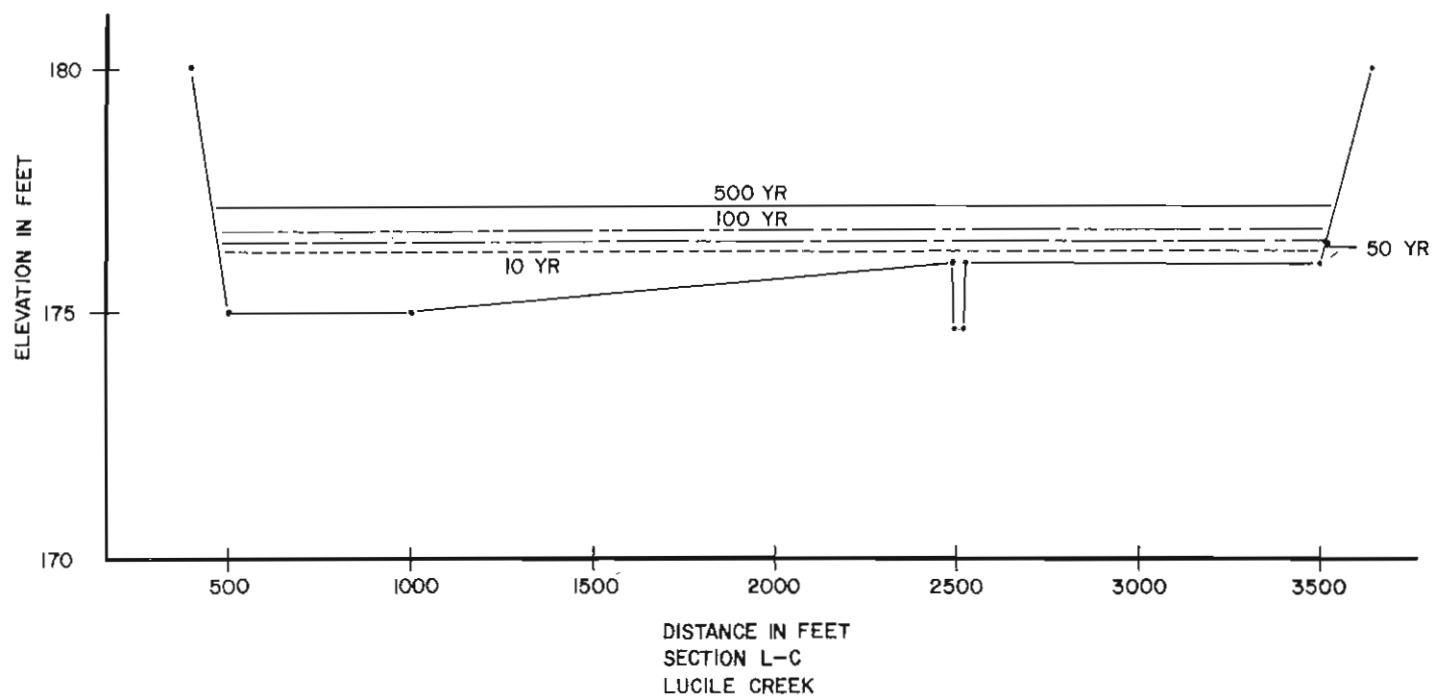

SOIL CONSERVATION SERVICE
US DEPARTMENT OF AGRICULTURE
TALKEETNA SUBBASIN
MATANUSKA-SUSITNA BOROUGH, ALASKA

FIGURE 144

TYPICAL VALLEY SECTION
PRESENT CONDITIONS

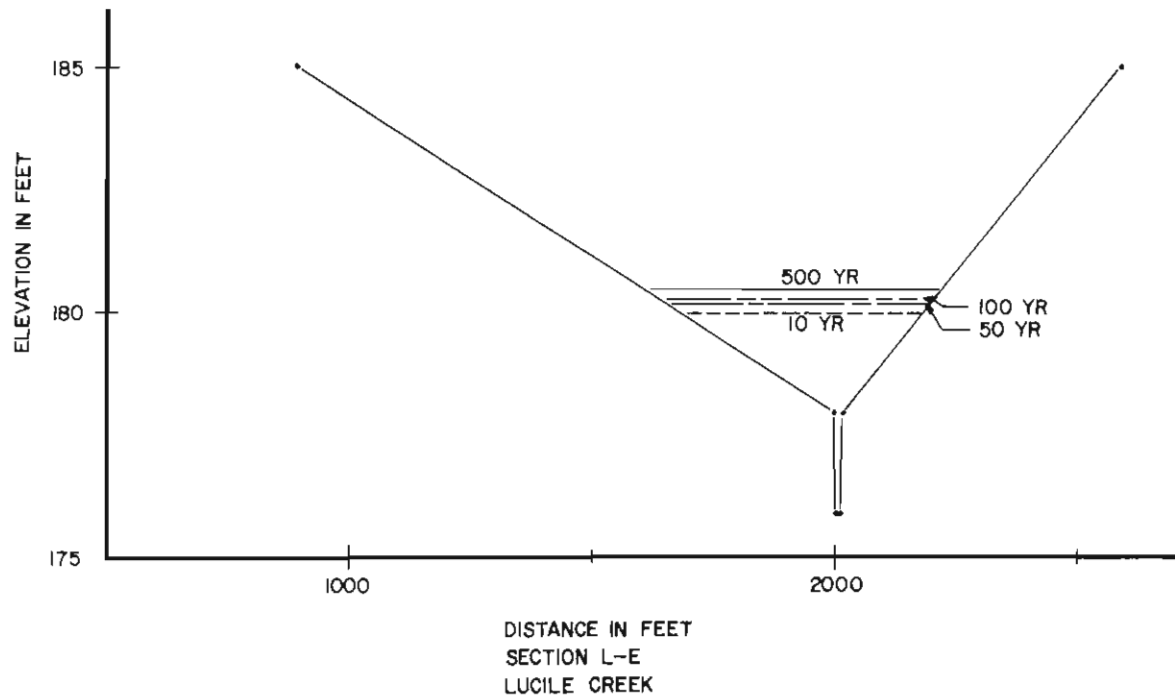

SOIL CONSERVATION SERVICE
U S DEPARTMENT OF AGRICULTURE
TALKEETNA SUBBASIN
MATANUSKA-SUSITNA BOROUGH, ALASKA

FIGURE 145

TYPICAL VALLEY SECTION
PRESENT CONDITIONS

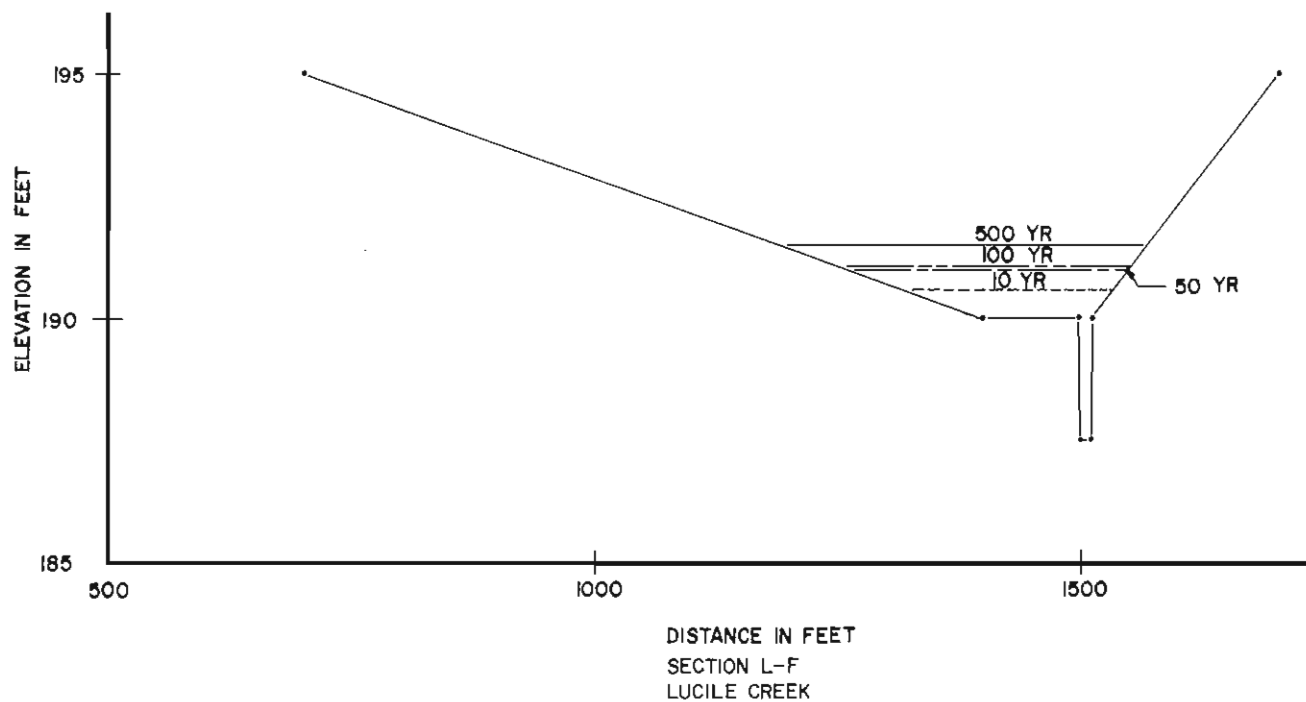

SOIL CONSERVATION SERVICE
U.S. DEPARTMENT OF AGRICULTURE
TALKEETNA SUBBASIN
MATANUSKA-SUSITNA BOROUGH, ALASKA

FIGURE 146

TYPICAL VALLEY SECTION
PRESENT CONDITIONS

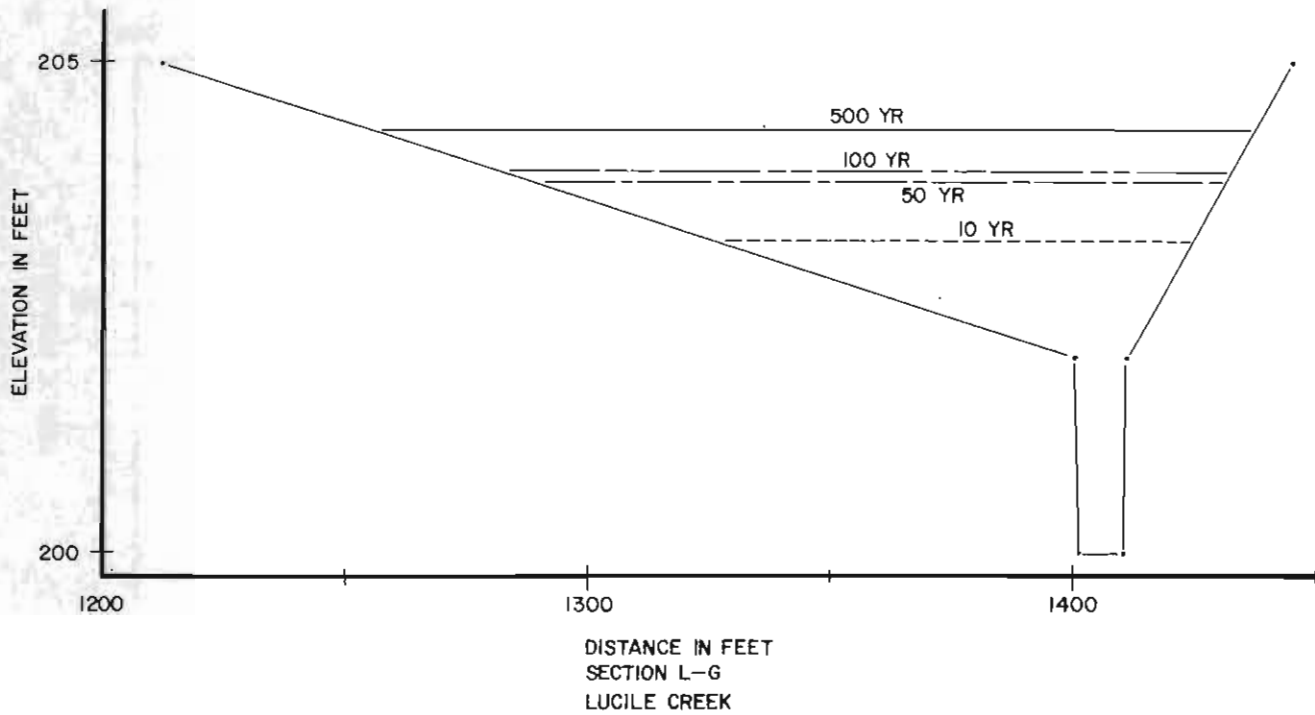

SOIL CONSERVATION SERVICE
U S DEPARTMENT OF AGRICULTURE
TALKEETNA SUBBASIN
MATANUSKA-SUSITNA BOROUGH, ALASKA

FIGURE 147

TYPICAL VALLEY SECTION
PRESENT CONDITIONS

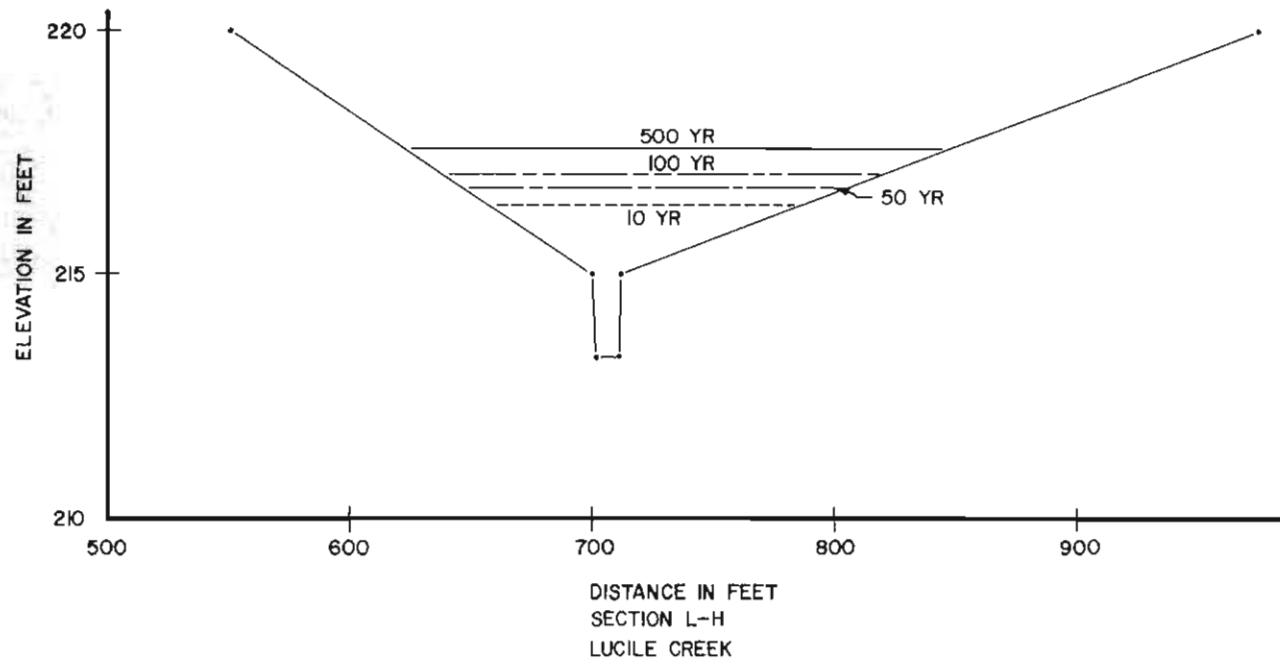

SOIL CONSERVATION SERVICE
U S DEPARTMENT OF AGRICULTURE
TALKEETNA SUBBASIN
MATANUSKA-SUSITNA BOROUGH, ALASKA

FIGURE 148

TYPICAL VALLEY SECTION
PRESENT CONDITIONS

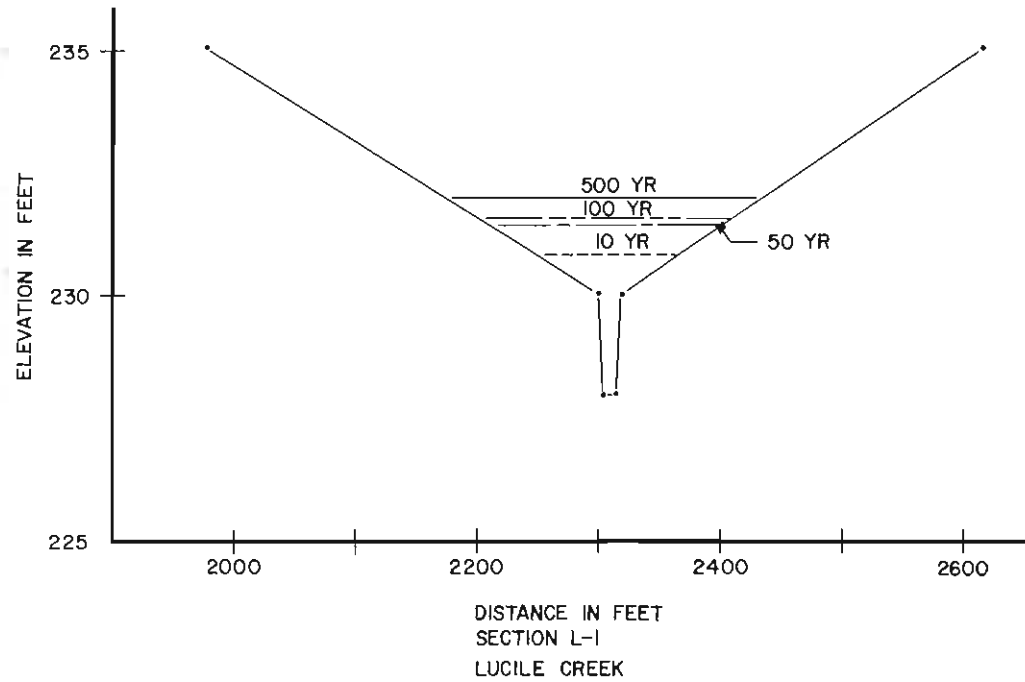

SOIL CONSERVATION SERVICE
U S DEPARTMENT OF AGRICULTURE
TALKEETNA SUBBASIN
MATANUSKA-SUSITNA BOROUGH, ALASKA

FIGURE 149

TYPICAL VALLEY SECTION
PRESENT CONDITIONS

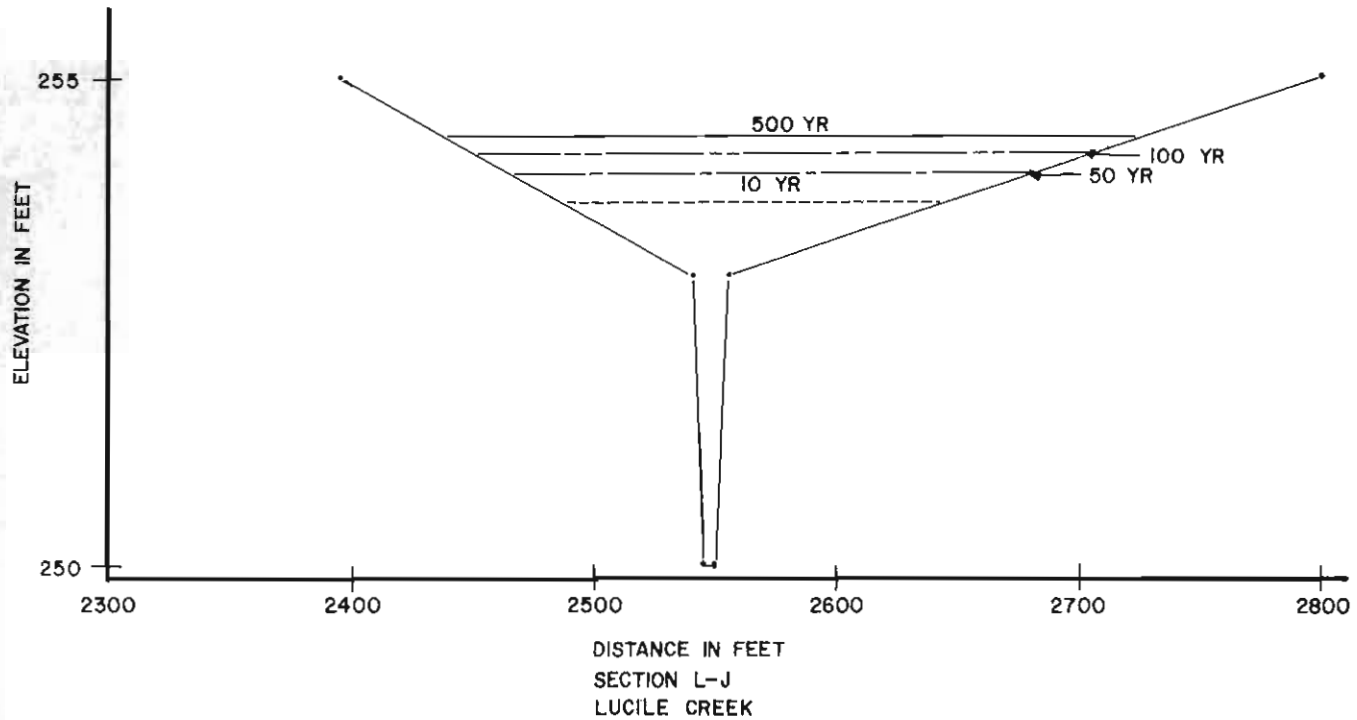

SOIL CONSERVATION SERVICE
U S DEPARTMENT OF AGRICULTURE
TALKEETNA SUBBASIN
MATANUSKA-SUSITNA BOROUGH, ALASKA

FIGURE 150

TYPICAL VALLEY SECTION
PRESENT CONDITIONS

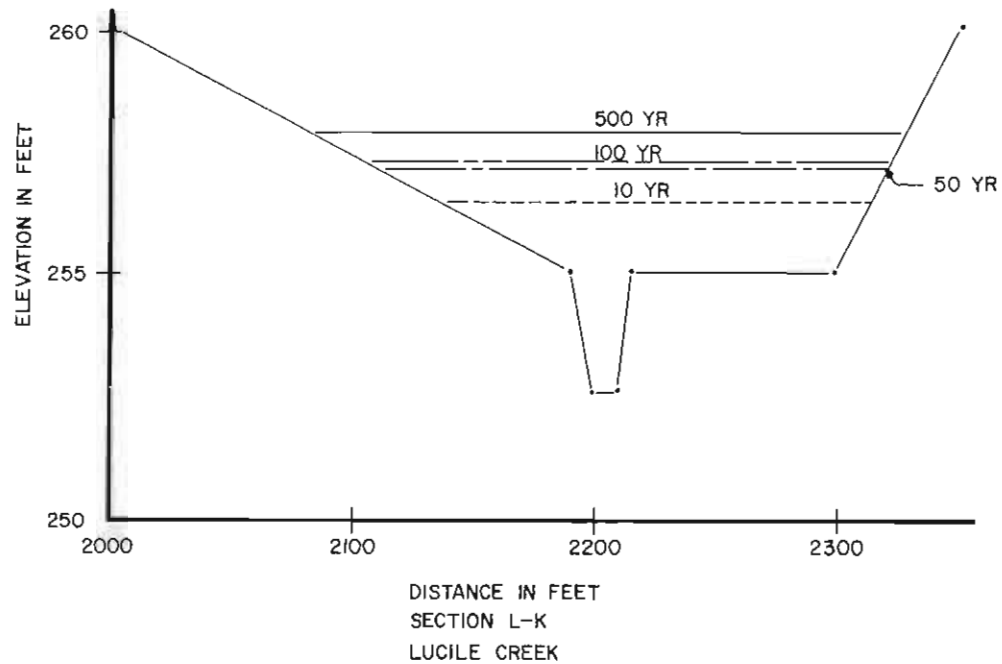

SOIL CONSERVATION SERVICE
US DEPARTMENT OF AGRICULTURE
TALKEETNA SUBBASIN
MATANUSKA-SUSITNA BOROUGH, ALASKA

FIGURE 151

TYPICAL VALLEY SECTION
PRESENT CONDITIONS

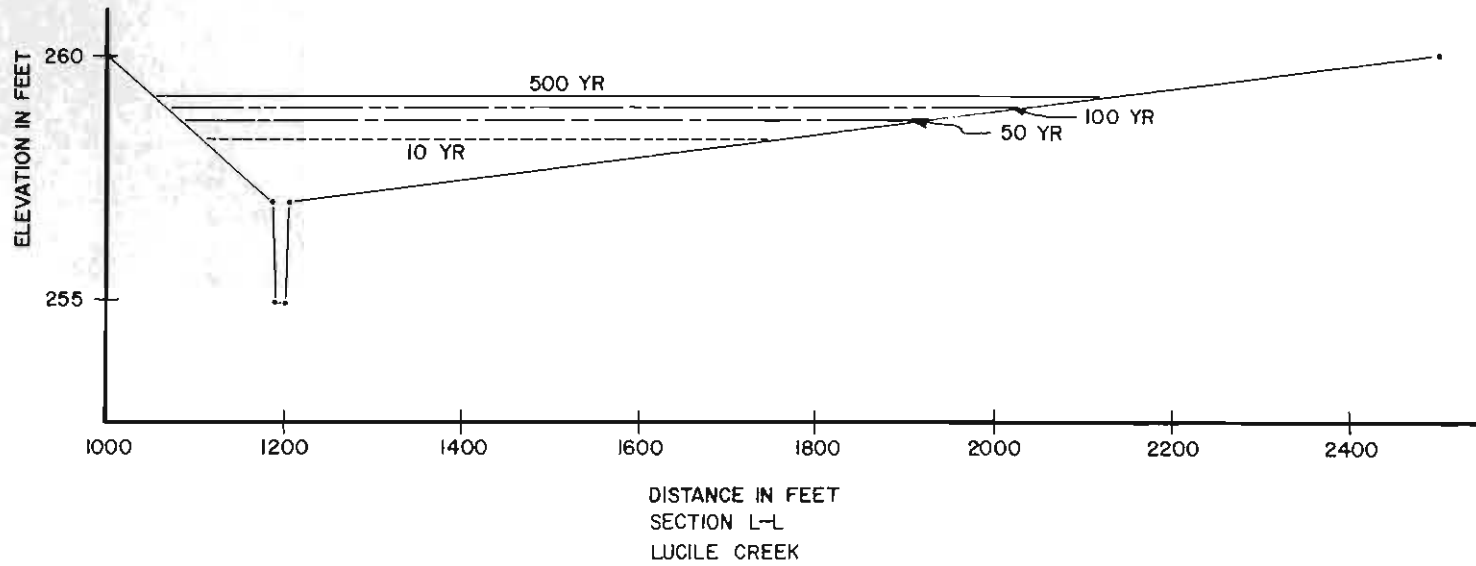

SOIL CONSERVATION SERVICE
U S DEPARTMENT OF AGRICULTURE
TALKEETNA SUBBASIN
MATANUSKA-SUSITNA BOROUGH, ALASKA

FIGURE 152

TYPICAL VALLEY SECTION
PRESENT CONDITIONS

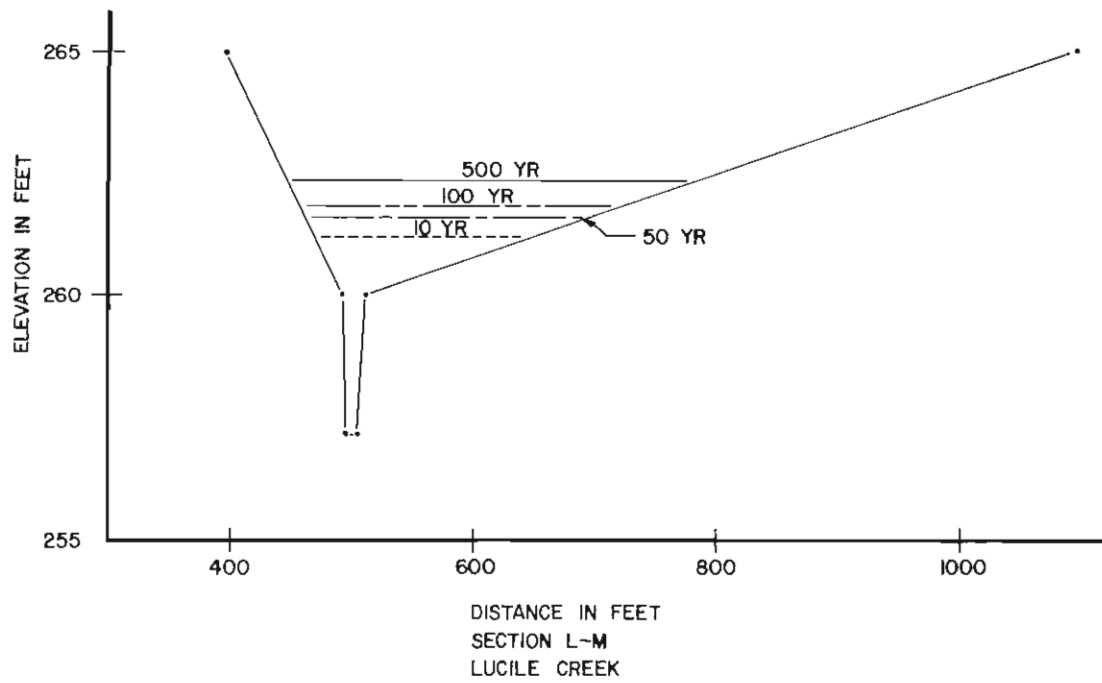

SOIL CONSERVATION SERVICE
U.S. DEPARTMENT OF AGRICULTURE
TALKEETNA SUBBASIN
MATANUSKA-SUSITNA BOROUGH, ALASKA

FIGURE 153

TYPICAL VALLEY SECTION
PRESENT CONDITIONS

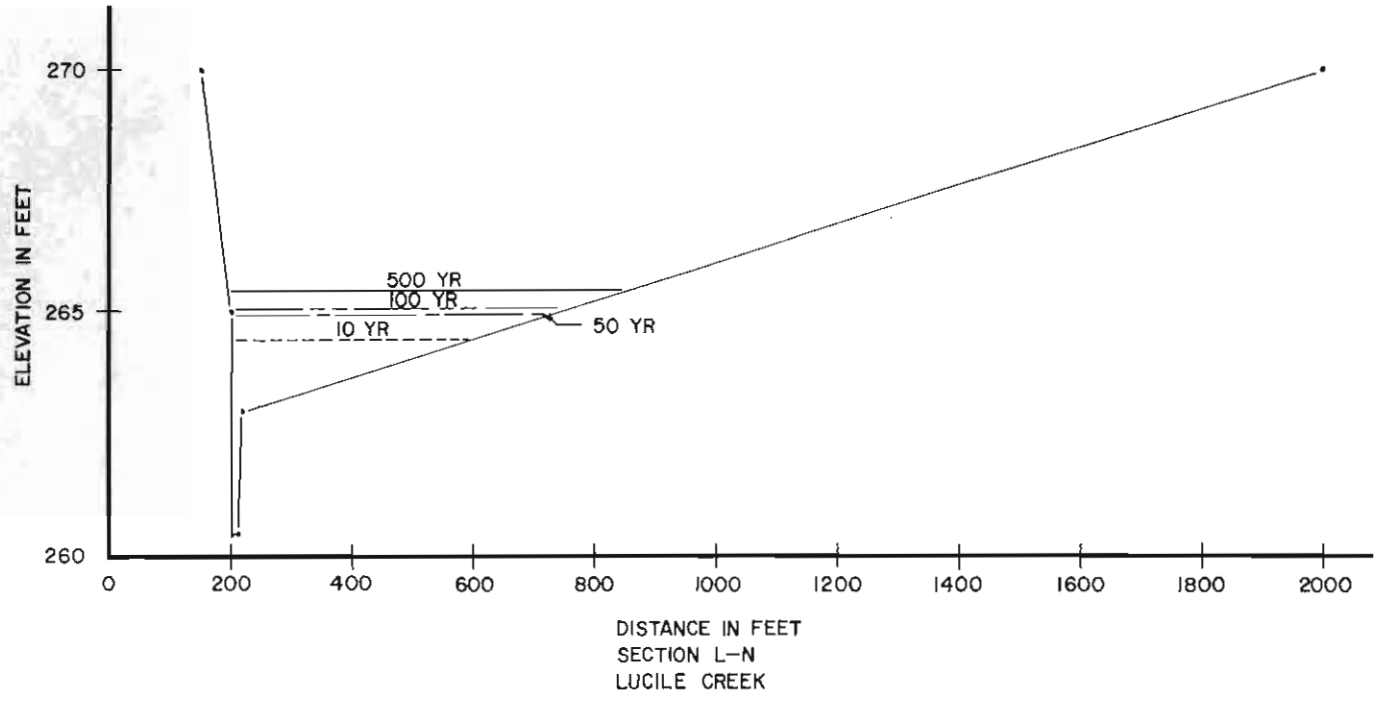

SOIL CONSERVATION SERVICE
U S DEPARTMENT OF AGRICULTURE
TALKEETNA SUBBASIN
MATANUSKA-SUSITNA BOROUGH, ALASKA

FIGURE 154

TYPICAL VALLEY SECTION
PRESENT CONDITIONS

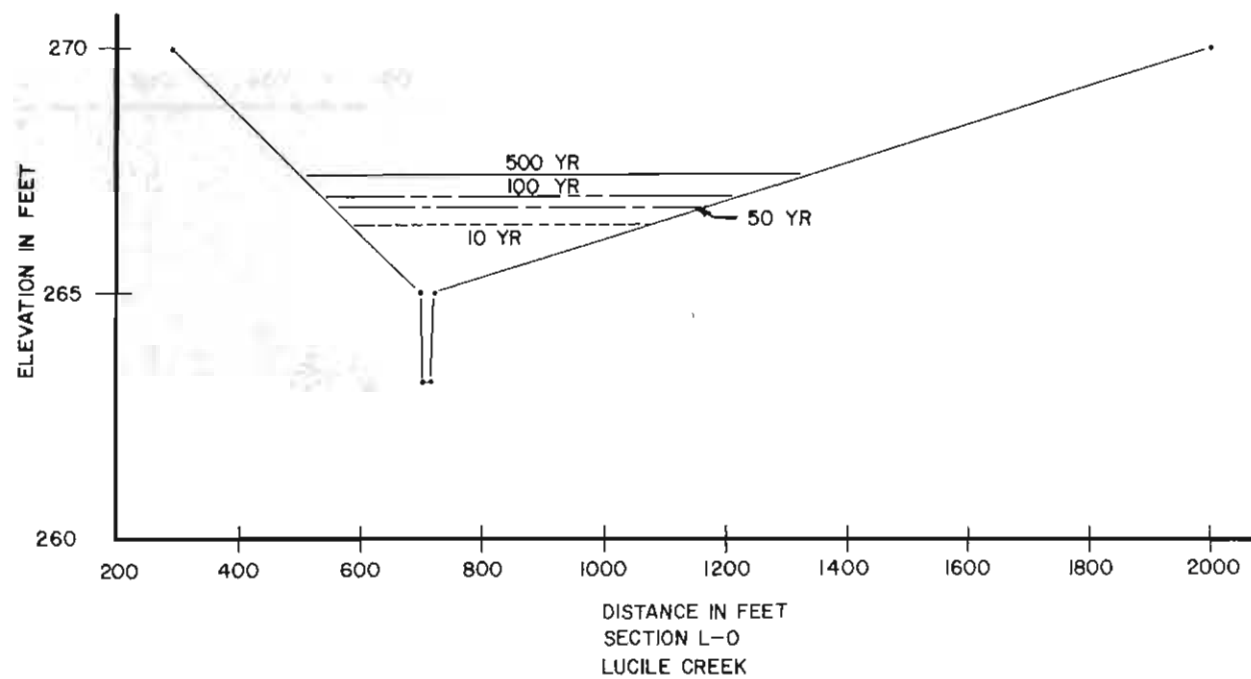

SOIL CONSERVATION SERVICE
U S DEPARTMENT OF AGRICULTURE
TALKEETNA SUBBASIN
MATANUSKA-SUSITNA BOROUGH, ALASKA

FIGURE 155

TYPICAL VALLEY SECTION
PRESENT CONDITIONS

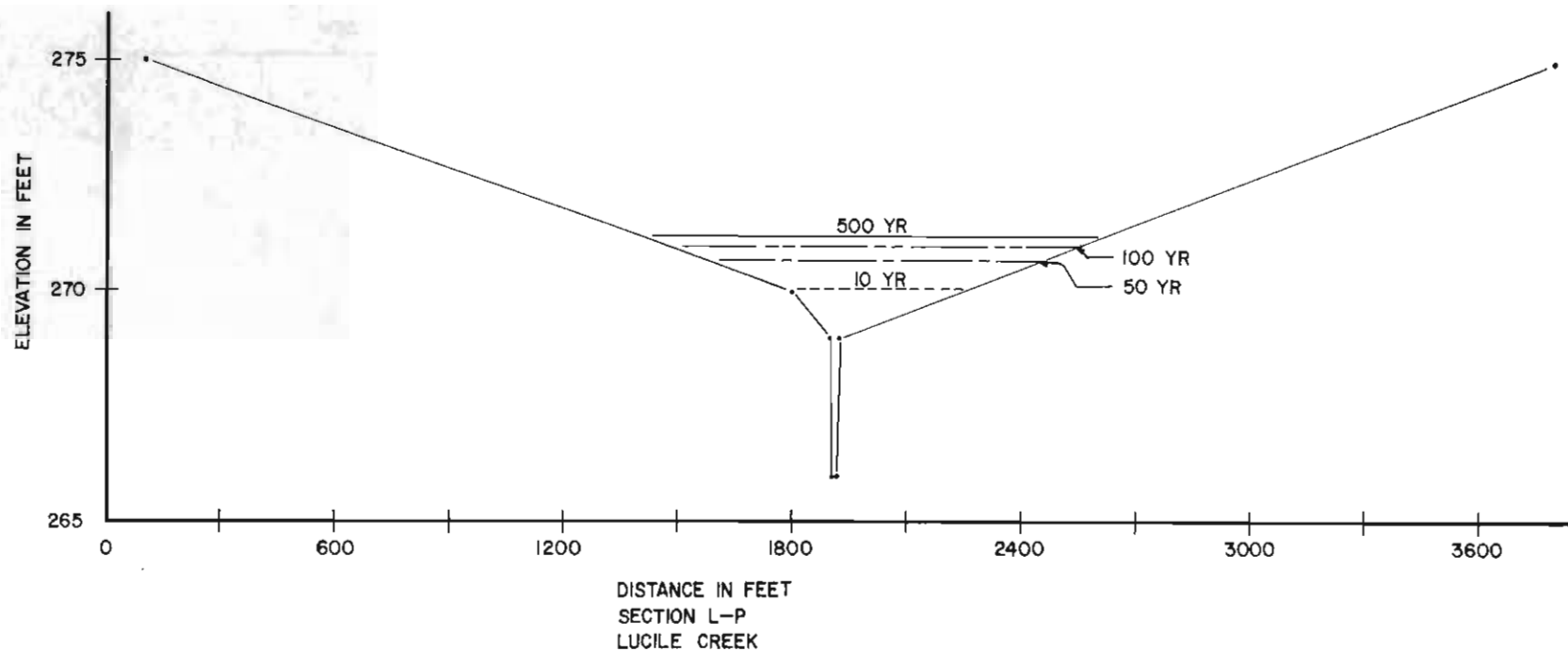

SOIL CONSERVATION SERVICE
U S DEPARTMENT OF AGRICULTURE
TALKEETNA SUBBASIN
MATANUSKA-SUSITNA BOROUGH, ALASKA

FIGURE 156

TYPICAL VALLEY SECTION
PRESENT CONDITIONS

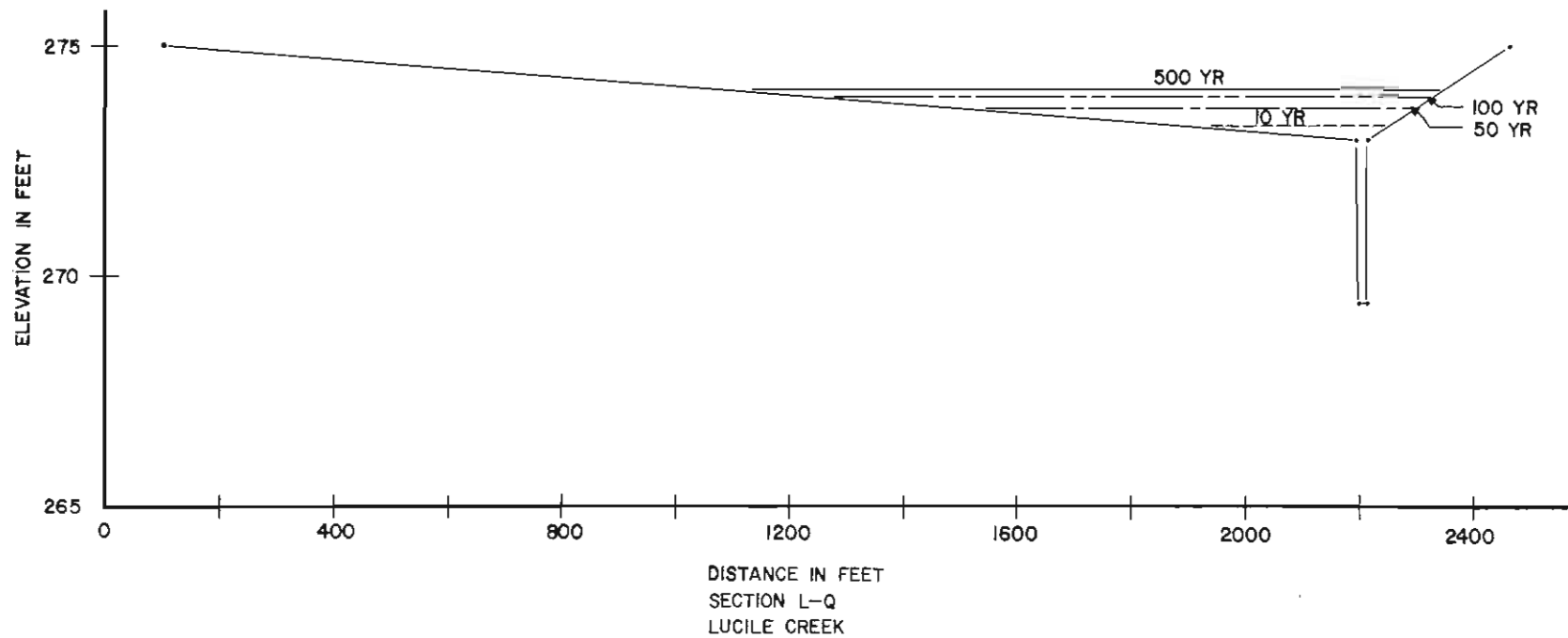

SOIL CONSERVATION SERVICE
U.S. DEPARTMENT OF AGRICULTURE
TALKEETNA SUBBASIN
MATANUSKA-SUSITNA BOROUGH, ALASKA

FIGURE 157

TYPICAL VALLEY SECTION
PRESENT CONDITIONS

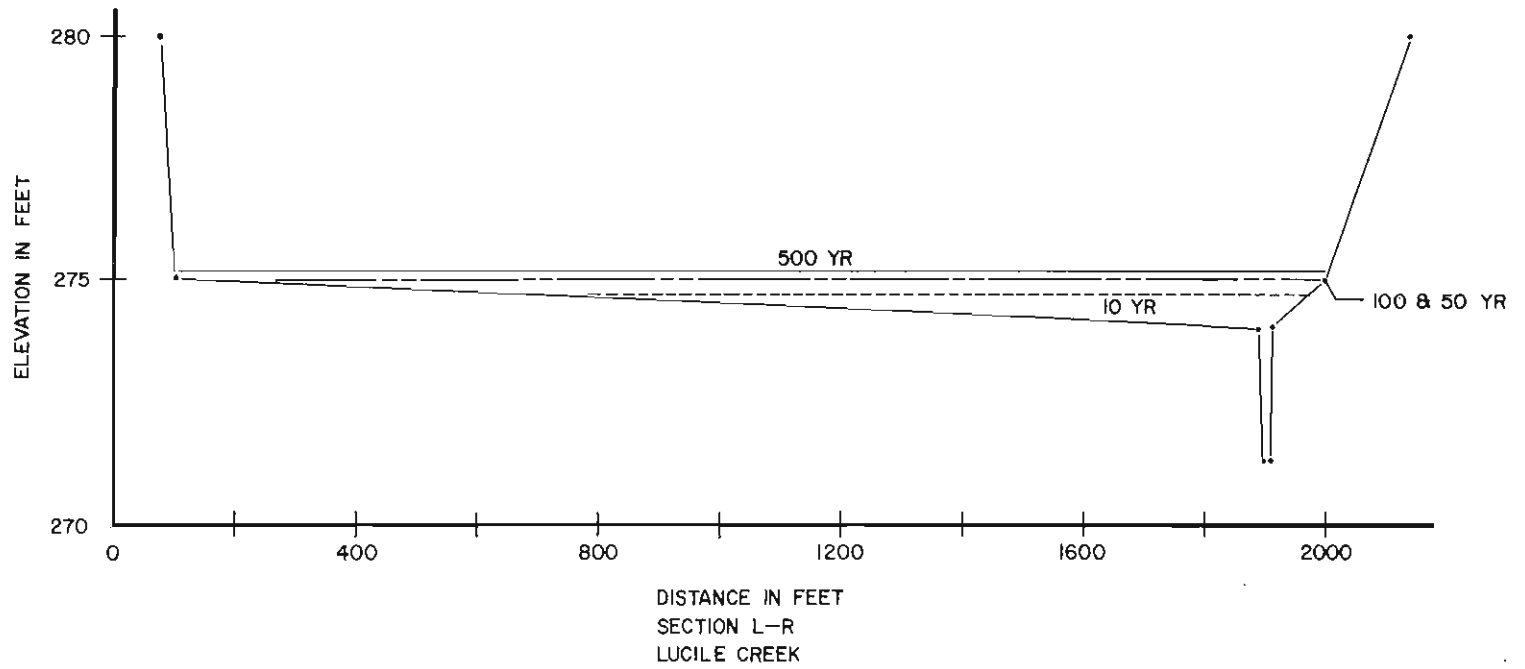

SOIL CONSERVATION SERVICE
U S DEPARTMENT OF AGRICULTURE
TALKEETNA SUBBASIN
MATANUSKA-SUSITNA BOROUGH, ALASKA

FIGURE 158

TYPICAL VALLEY SECTION
PRESENT CONDITIONS

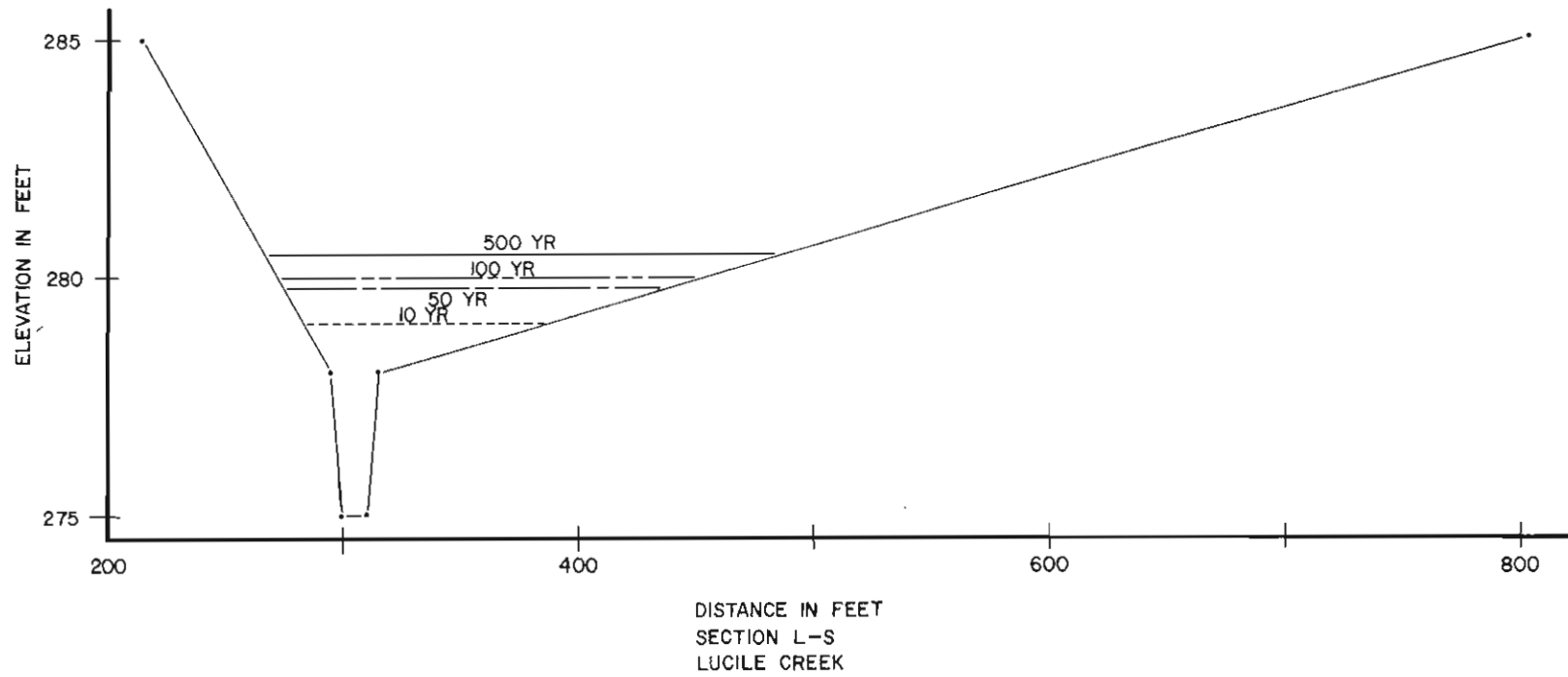

SOIL CONSERVATION SERVICE
U S DEPARTMENT OF AGRICULTURE
TALKEETNA SUBBASIN
MATANUSKA-SUSITNA BOROUGH, ALASKA

FIGURE 159

TYPICAL VALLEY SECTION
PRESENT CONDITIONS

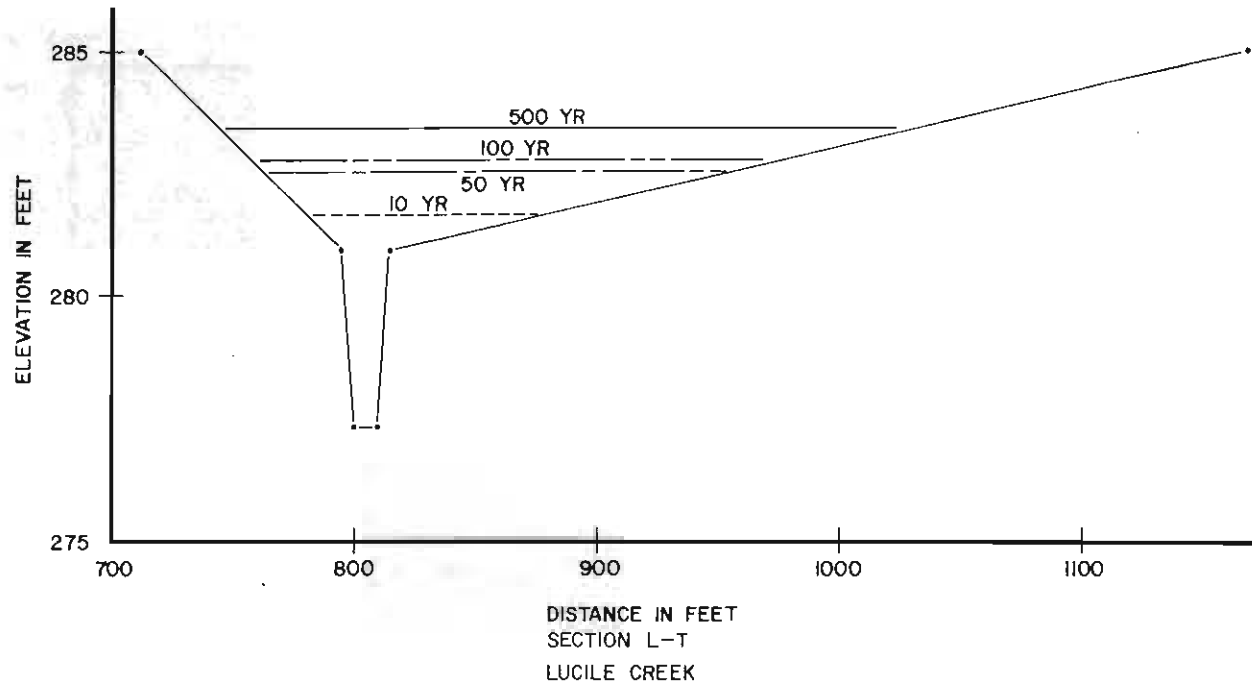

SOIL CONSERVATION SERVICE
U.S. DEPARTMENT OF AGRICULTURE
TALKEETNA SUBBASIN
MATANUSKA-SUSITNA BOROUGH, ALASKA

FIGURE 160

TYPICAL VALLEY SECTION
PRESENT CONDITIONS

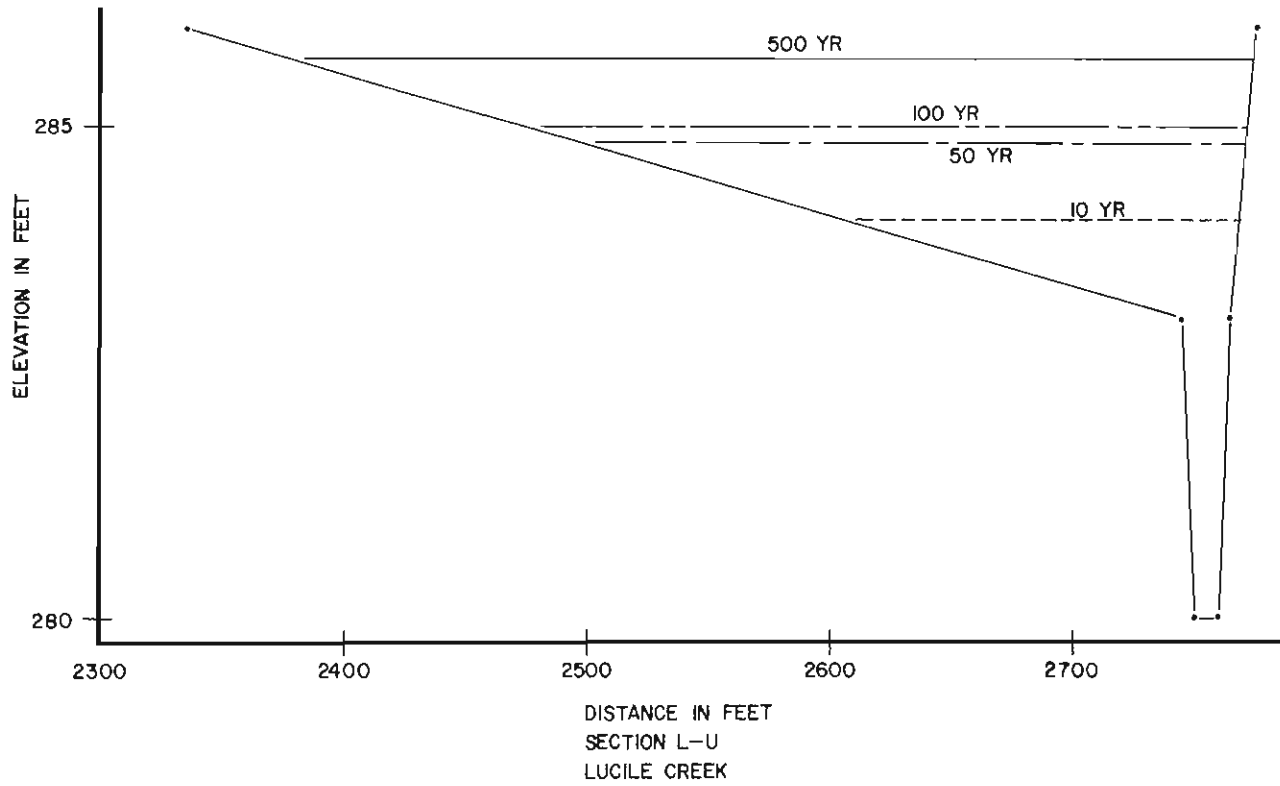

SOIL CONSERVATION SERVICE
U S DEPARTMENT OF AGRICULTURE
TALKEETNA SUBBASIN
MATANUSKA-SUSITNA BOROUGH, ALASKA

FIGURE 161

TYPICAL VALLEY SECTION
PRESENT CONDITIONS

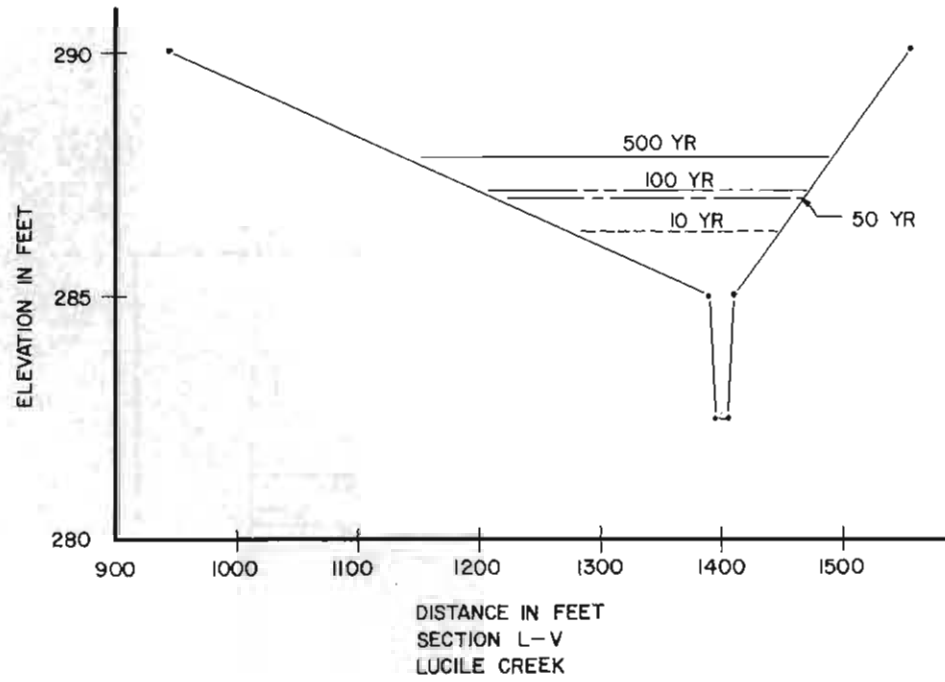

SOIL CONSERVATION SERVICE
U.S. DEPARTMENT OF AGRICULTURE
TALKEETNA SUBBASIN
MATANUSKA-SUSITNA BOROUGH, ALASKA

FIGURE 162

TYPICAL VALLEY SECTION
PRESENT CONDITIONS

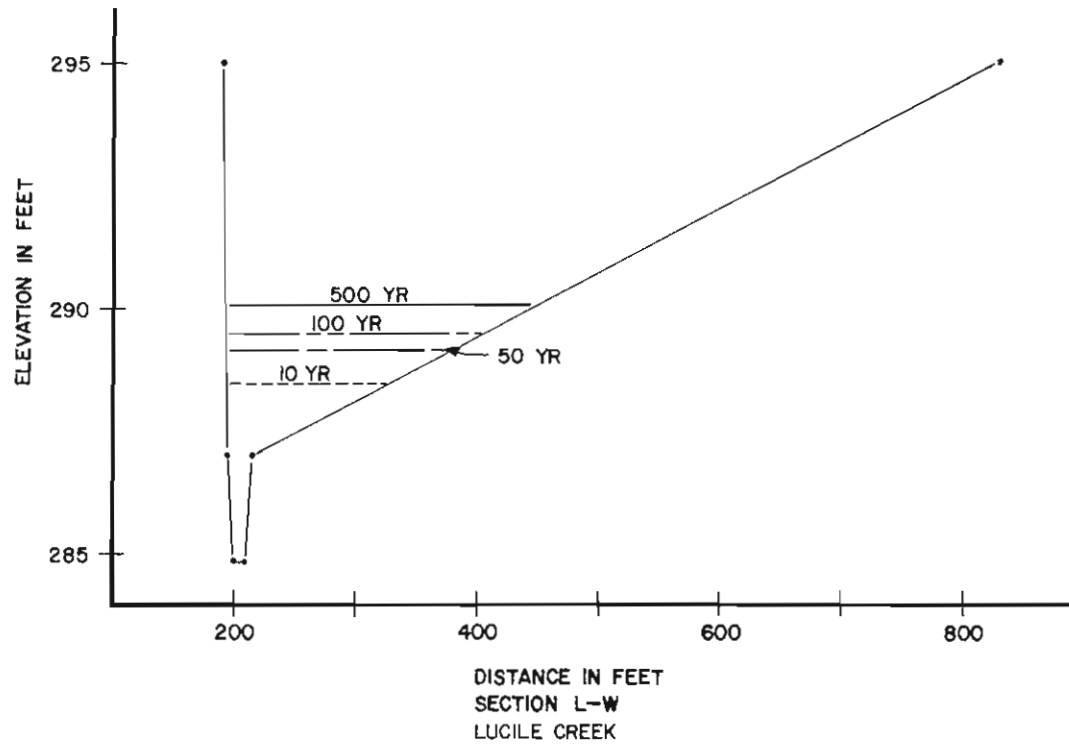

SOIL CONSERVATION SERVICE
U.S. DEPARTMENT OF AGRICULTURE
TALKEETNA SUBBASIN
MATANUSKA-SUSITNA BOROUGH, ALASKA

FIGURE 163

TYPICAL VALLEY SECTION
PRESENT CONDITIONS

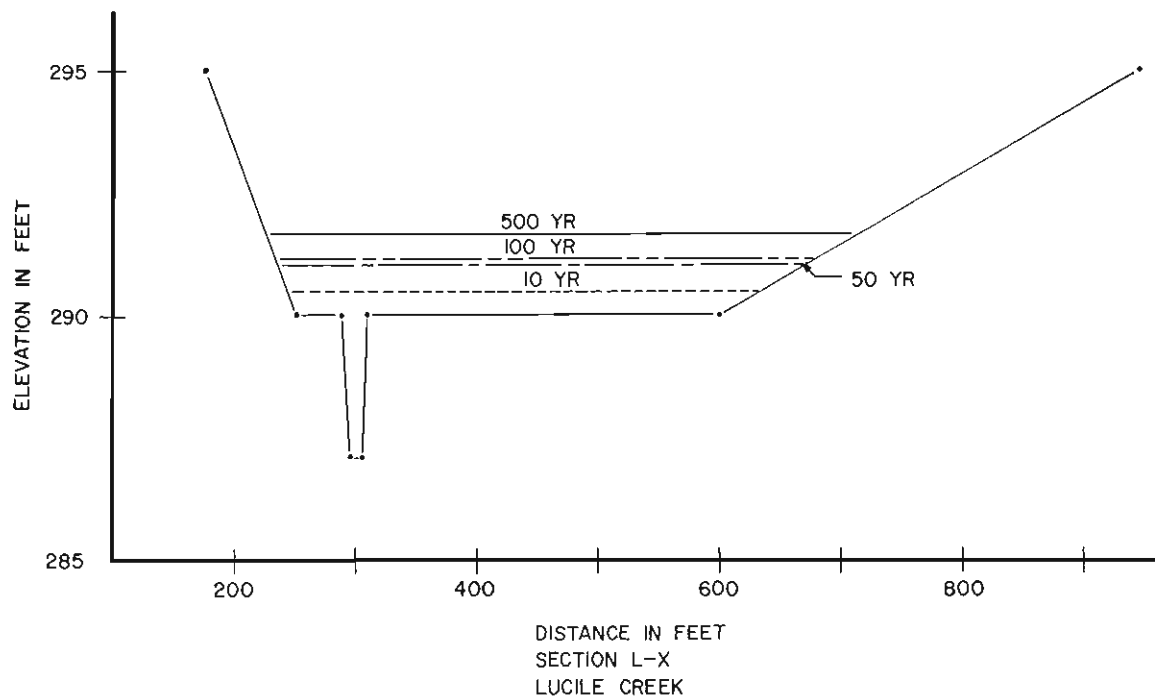

SOIL CONSERVATION SERVICE
U S DEPARTMENT OF AGRICULTURE
TALKEETNA SUBBASIN
MATANUSKA-SUSITNA BOROUGH, ALASKA

FIGURE 164

TYPICAL VALLEY SECTION
PRESENT CONDITIONS

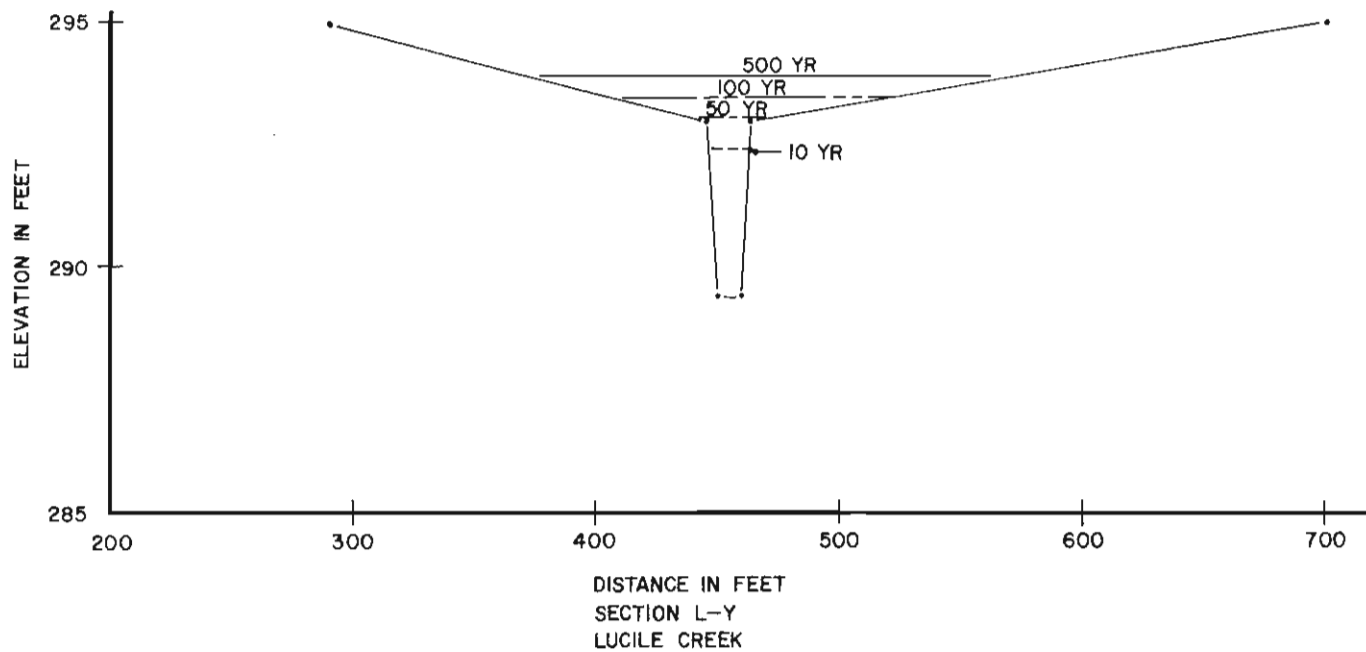

SOIL CONSERVATION SERVICE
U.S. DEPARTMENT OF AGRICULTURE
TALKEETNA SUBBASIN
MATANUSKA-SUSITNA BOROUGH, ALASKA

FIGURE 165

TYPICAL VALLEY SECTION
PRESENT CONDITIONS

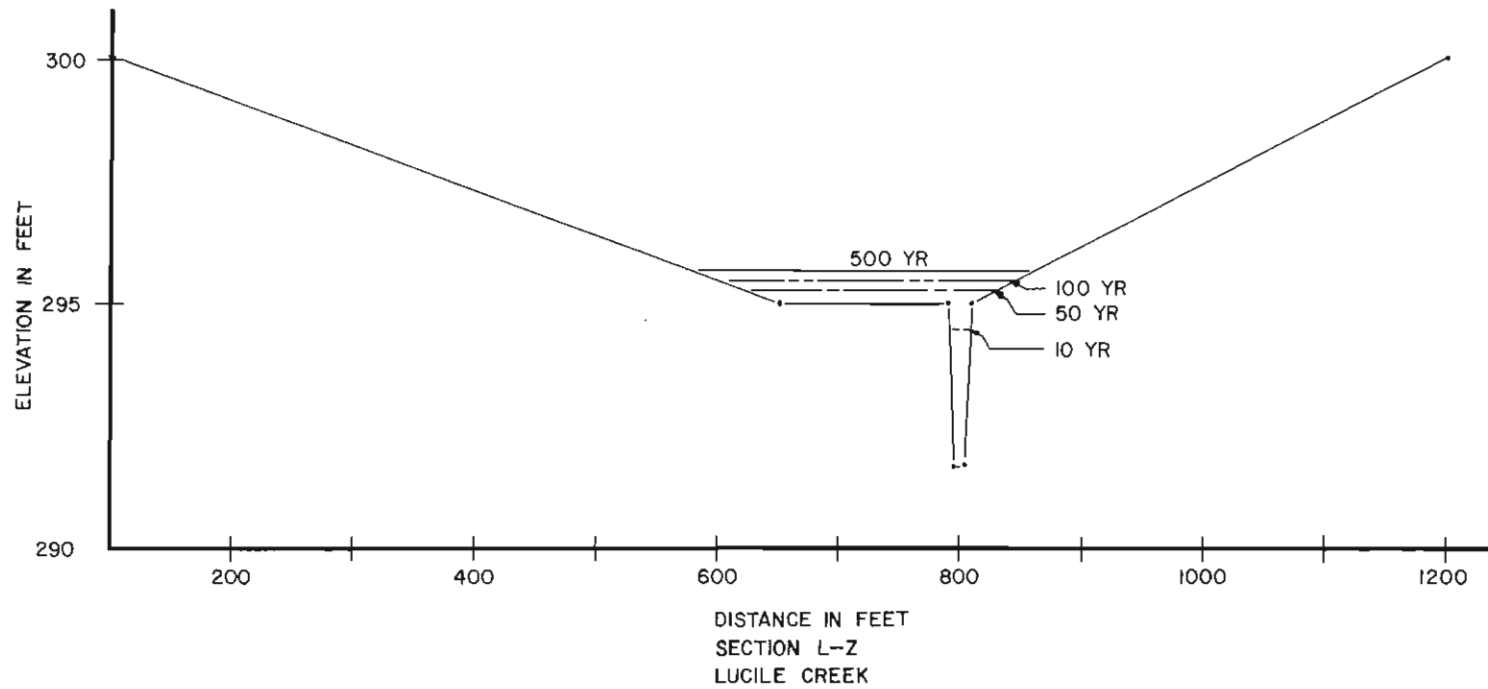

SOIL CONSERVATION SERVICE
U S DEPARTMENT OF AGRICULTURE
TALKEETNA SUBBASIN
MATANUSKA-SUSITNA BOROUGH, ALASKA

FIGURE 166

TYPICAL VALLEY SECTION
PRESENT CONDITIONS

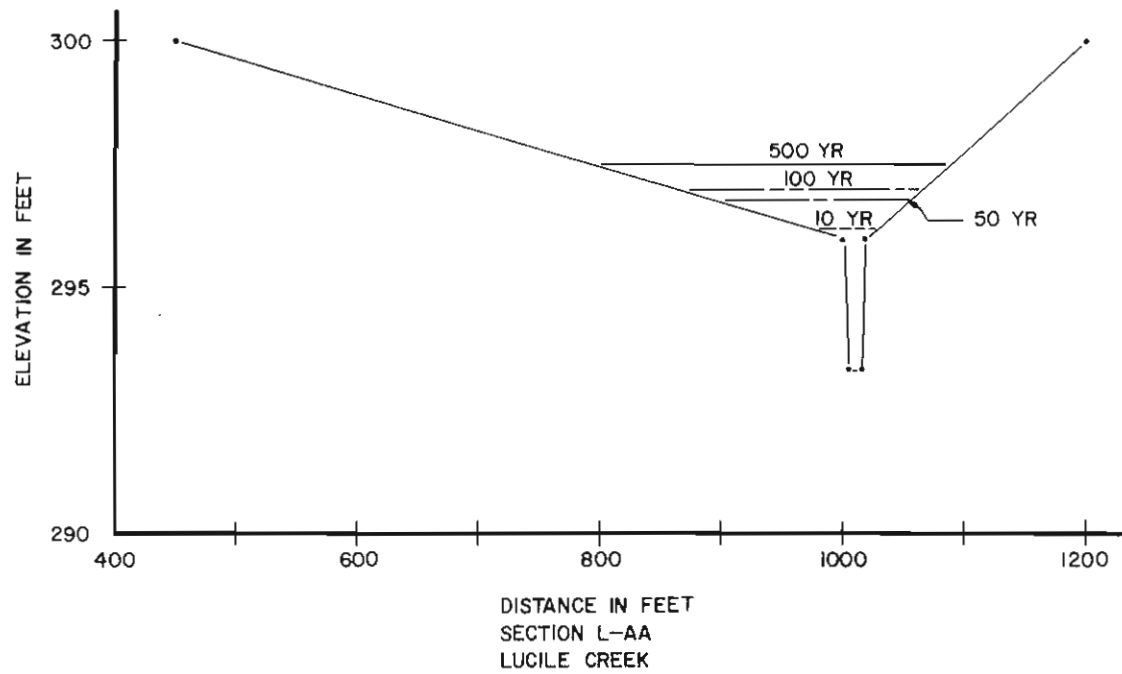

SOIL CONSERVATION SERVICE
U S DEPARTMENT OF AGRICULTURE
TALKEETNA SUBBASIN
MATANUSKA-SUSITNA BOROUGH, ALASKA

FIGURE 167

TYPICAL VALLEY SECTION
PRESENT CONDITIONS

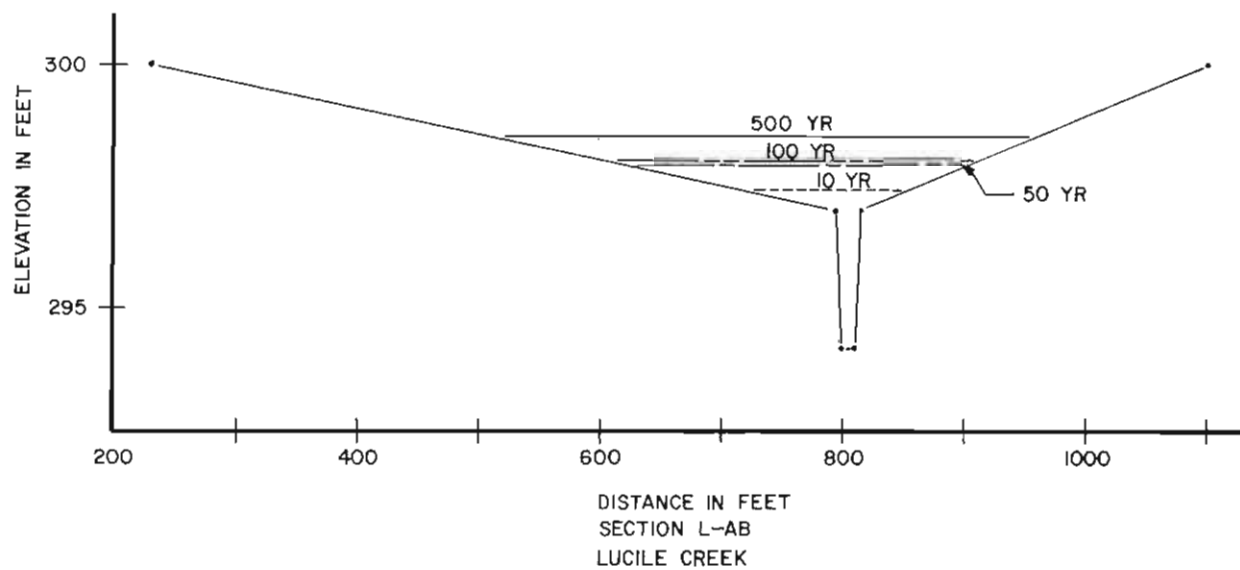

SOIL CONSERVATION SERVICE
US DEPARTMENT OF AGRICULTURE
TALKEETNA SUBBASIN
MATANUSKA-SUSITNA BOROUGH, ALASKA

FIGURE 168

TYPICAL VALLEY SECTION
PRESENT CONDITIONS

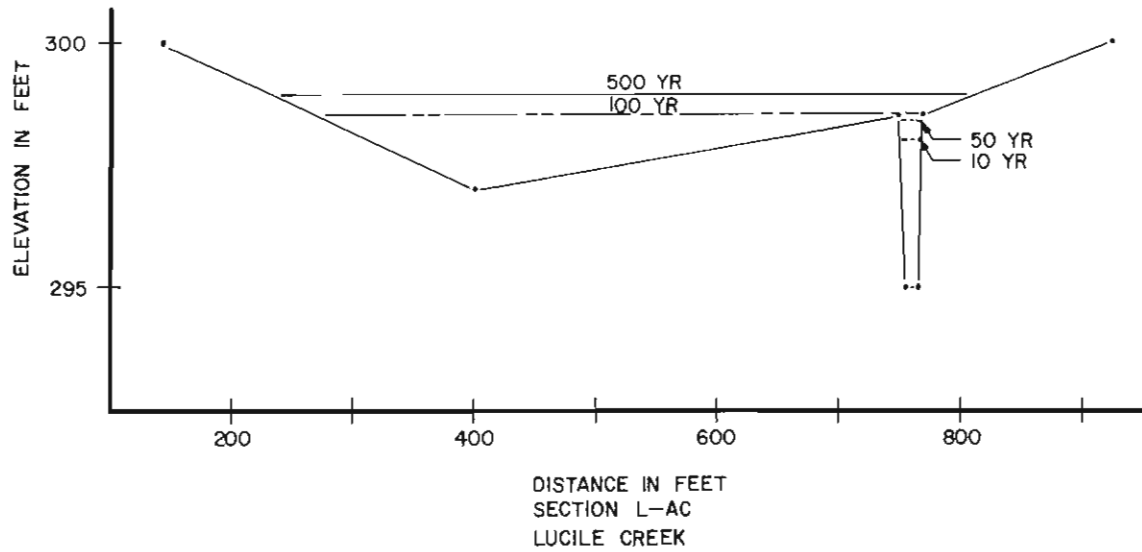

SOIL CONSERVATION SERVICE
U S DEPARTMENT OF AGRICULTURE
TALKEETNA SUBBASIN
MATANUSKA-SUSITNA BOROUGH, ALASKA

FIGURE 169

TYPICAL VALLEY SECTION
PRESENT CONDITIONS

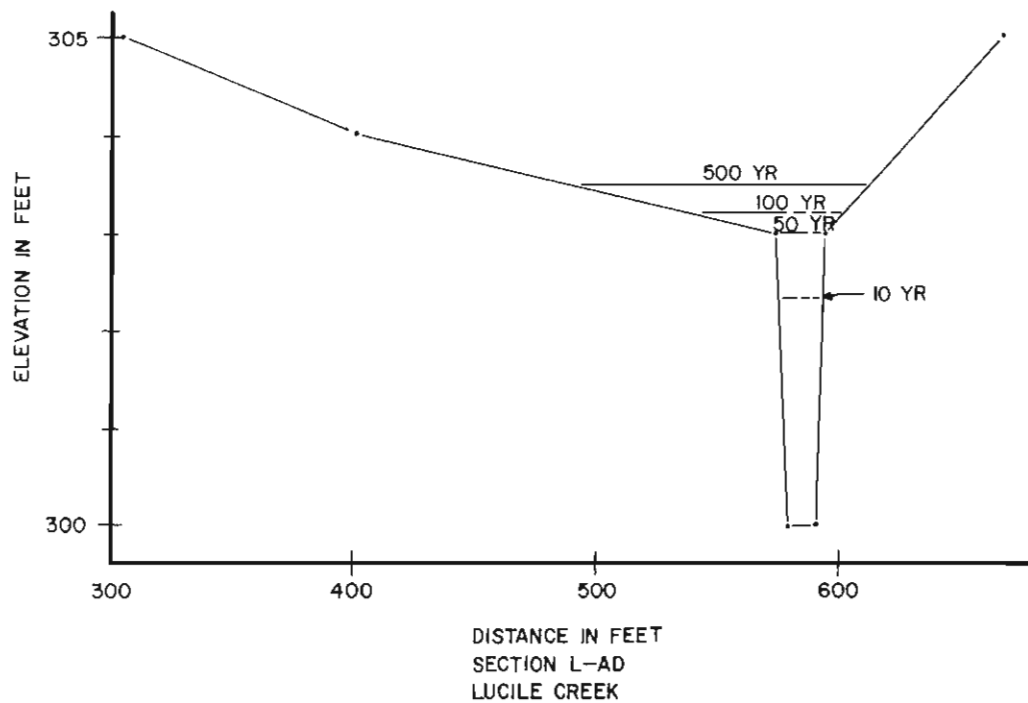

SOIL CONSERVATION SERVICE
U S DEPARTMENT OF AGRICULTURE
TALKEETNA SUBBASIN
MATANUSKA-SUSITNA BOROUGH, ALASKA

FIGURE 170

TYPICAL VALLEY SECTION
PRESENT CONDITIONS

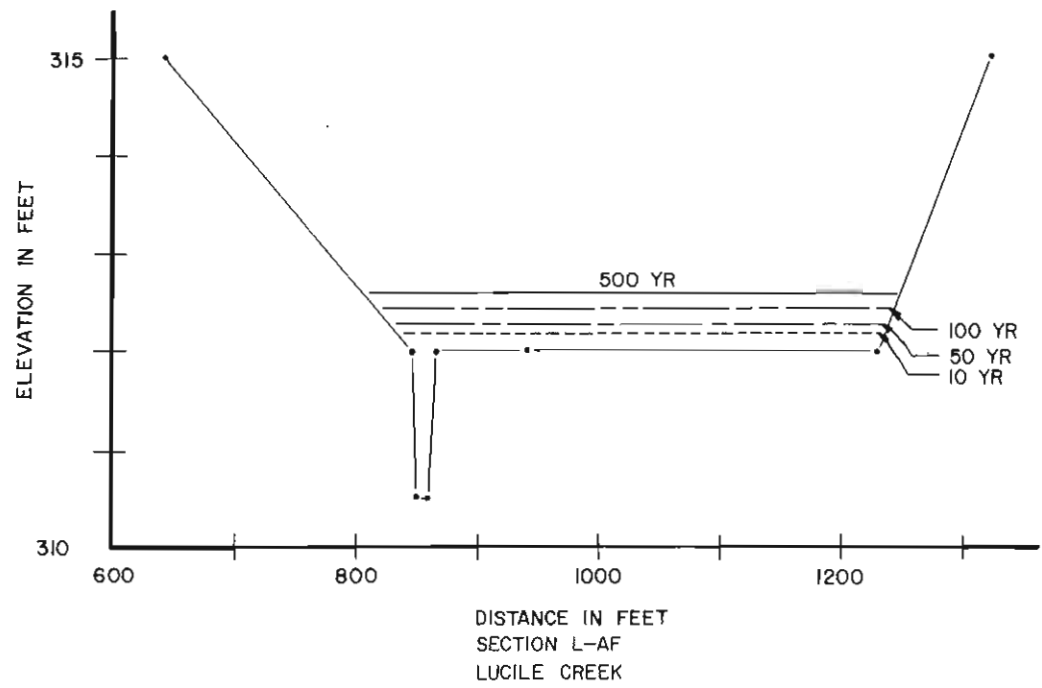

SOIL CONSERVATION SERVICE
U S DEPARTMENT OF AGRICULTURE
TALKEETNA SUBBASIN
MATANUSKA-SUSITNA BOROUGH, ALASKA

FIGURE 172

TYPICAL VALLEY SECTION
PRESENT CONDITIONS

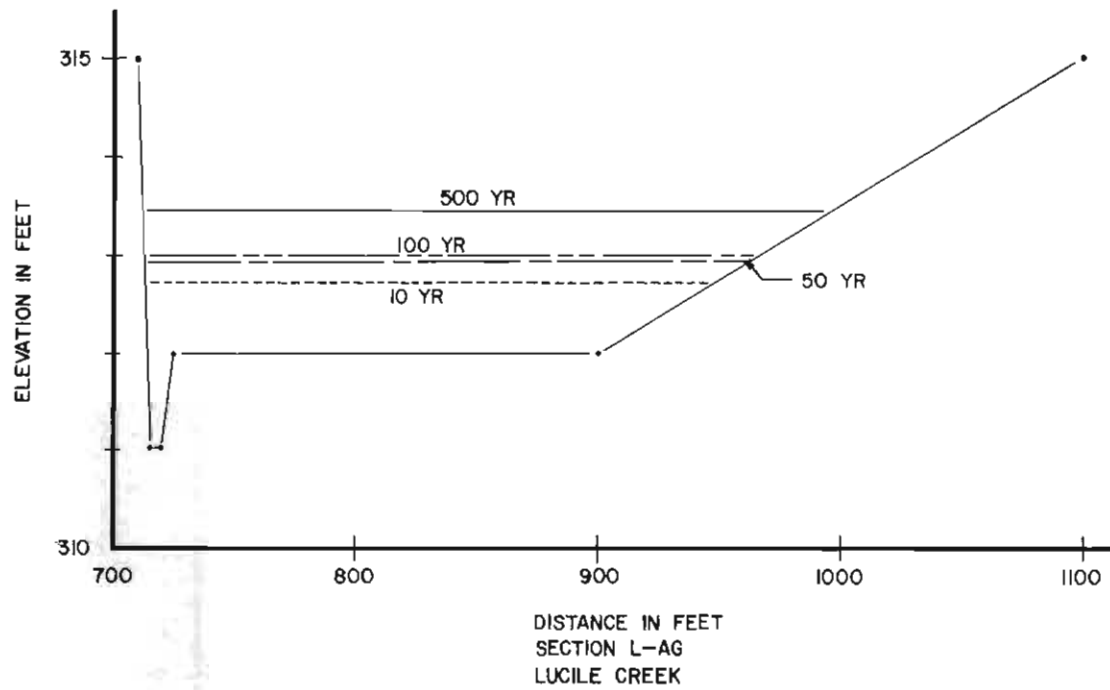

SOIL CONSERVATION SERVICE
US DEPARTMENT OF AGRICULTURE
TALKEETNA SUBBASIN
MATANUSKA-SUSITNA BOROUGH, ALASKA

FIGURE 173

TYPICAL VALLEY SECTION
PRESENT CONDITIONS

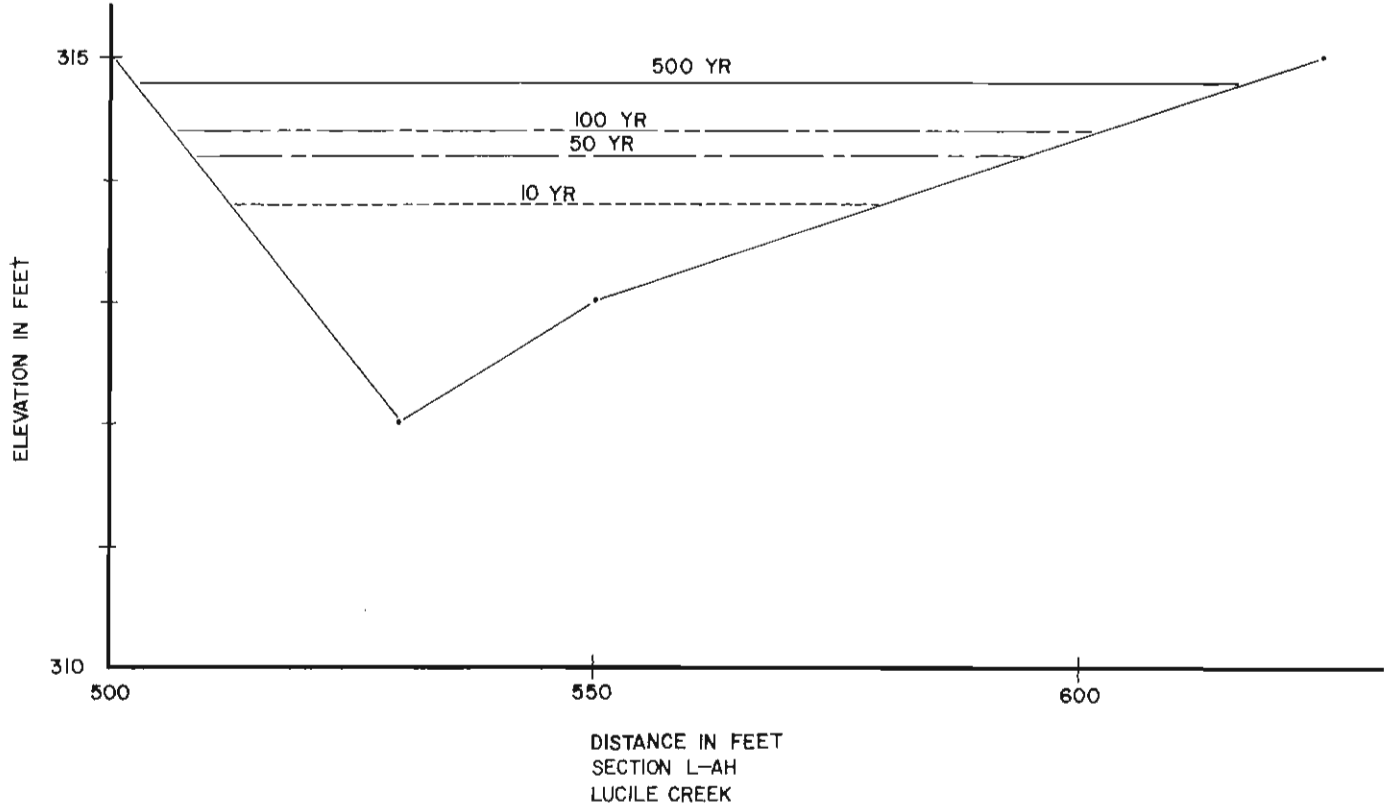

SOIL CONSERVATION SERVICE
U S DEPARTMENT OF AGRICULTURE
TALKEETNA SUBBASIN
MATANUSKA-SUSITNA BOROUGH, ALASKA

FIGURE 174

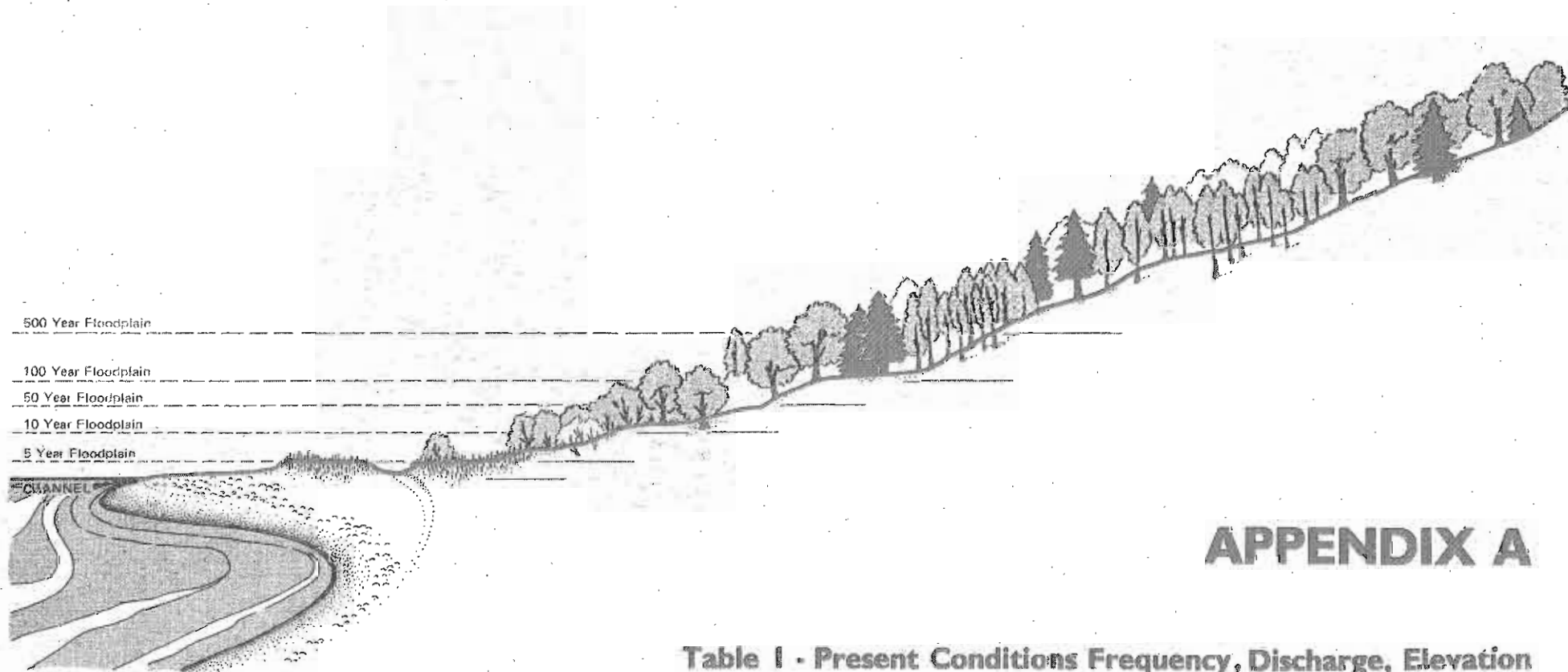

APPENDIX A

**Table I - Present Conditions Frequency, Discharge, Elevation
Data at Valley Cross Sections**

Table 1 Present Conditions: Frequency-Discharge-Elevation Data at Valley Sections Wasilla, Cottonwood, Lucile Creeks, and Kashwitna River Susitna River Basin

Valley Section	Photo-Map (No.)	Profile Sheet (No.)	Drainage Area (Sq. Mi.)	10-Year Storm		50-Year Storm		100-Year Storm		500-Year Storm		Channel Bottom
				Disch. (cfs)	Elev. msl	Disch. (cfs)	Elev. msl	Disch. (cfs)	Elev. msl	Disch. (cfs)	Elev. msl	Elev. (feet)
<u>Kashwitna River</u>												
K-A	1	1	352.2	11300	163.5	14792	164.3	16518	164.5	20111	164.8	130.0
K-B	1	1	352.2	11300	163.5	14792	164.3	16518	164.5	20111	164.8	131.3
K-C	1	1	352.2	11300	163.5	14792	164.3	16518	164.5	20111	164.8	132.7
K-D	1	1	352.2	11300	163.5	14792	164.4	16518	164.6	20111	164.9	136.1
K-E	1	1	352.2	11300	163.6	14792	164.4	16518	164.6	20111	165.0	145.0
K-F	1	1	352.2	11300	164.7	14792	165.6	16518	165.9	20111	166.4	150.0
K-G	1	1	352.2	11300	165.7	14792	166.7	16518	167.0	20111	167.7	151.3
K-H	1	2	352.2	11300	167.8	14792	168.7	16518	169.0	20111	169.7	154.0
K-I	1	2	352.2	11300	170.2	14792	171.2	16518	171.6	20111	172.3	155.4
K-J	1	2	352.2	11270	171.3	14748	172.4	16468	172.7	20049	173.5	160.2
K-KHY	1	2	352.2	11270	171.8	14748	173.3	16468	176.7	20049	177.5	160.5
K-L	1	2	351.0	11270	171.9	14748	173.5	16468	176.7	20049	177.5	160.5
K-M	1	2	351.0	11270	173.5	14748	174.7	16468	177.1	20049	177.9	160.5
K-N	1	3	351.0	11270	177.8	14748	178.8	16468	179.7	20049	180.3	160.5
K-O	1	3	350.0	11270	182.8	14748	183.5	16468	183.8	20049	184.3	166.7
K-P	2	3	350.0	11270	184.1	14748	184.8	16468	185.2	20049	185.8	171.6
K-Q	2	3	350.0	11270	185.3	14748	186.2	16468	186.6	20049	187.3	174.0
K-RRR	2	3	350.0	11270	186.8	14748	188.1	16468	188.7	20049	189.9	174.0
K-S	2	3	350.0	11270	186.8	14748	188.2	16468	188.8	20049	190.0	174.1
K-T	2	3	350.0	11270	188.7	14748	190.0	16468	190.6	20049	191.6	176.4
K-U	2	4	350.0	11270	192.2	14748	193.3	16468	193.9	20049	194.8	179.5
K-V	2	4	350.0	11270	196.6	14748	197.3	16468	197.7	20049	198.4	184.4
K-W	2	4	350.0	11270	199.4	14748	200.6	16468	201.1	20049	201.9	185.0
K-Y	2	5	350.0	11270	207.1	14748	207.8	16468	208.1	20049	208.7	195.5
K-Z	2	5	350.0	11270	210.6	14706	211.3	16422	211.5	19993	212.0	199.4

Table 1 Present Conditions: Frequency-Discharge-Elevation Data at Valley Sections Wasilla, Cottonwood, Lucile Creeks, and Kashwitna River Susitna River Basin

Valley Section	Photo-Map (No.)	Profile Sheet (No.)	Drainage Area (Sq. Mi.)	10-Year Storm		50-Year Storm		100-Year Storm		500-Year Storm		Channel Bottom
				Disch. (cfs)	Elev. msl (feet)	Disch. (cfs)	Elev. msl (feet)	Disch. (cfs)	Elev. msl (feet)	Disch. (cfs)	Elev. msl (feet)	Elev. msl (feet)
<u>Cottonwood Creek</u>												
C-A	3	17	26.4	327	57.1	553	58.1	655	58.4	930	59.7	43.3
C-B	3	17	26.4	327	59.3	553	60.5	655	60.8	930	62.1	48.6
C-C	3	17	26.4	327	65.0	553	65.8	655	66.0	930	66.7	63.3
C-D	3	17	26.4	327	72.0	553	72.7	655	72.9	930	73.5	68.3
C-E	3	17	26.4	327	73.5	553	74.4	655	74.7	930	75.4	70.8
C-F	3	17	26.4	327	83.1	553	83.5	655	83.7	930	84.0	79.9
C-G	3	17	26.4	327	87.1	553	88.1	655	88.3	930	88.9	83.3
C-H	3	17	26.4	327	94.8	553	95.7	655	96.0	930	96.7	92.3
C-I	3	17	26.4	327	100.0	553	101.0	655	101.1	930	101.9	97.1
C-JRD	3	17	26.4	327	105.1	553	105.3	655	105.3	930	105.5	98.4
C-K	3	17	26.4	327	105.1	553	105.3	655	105.3	930	105.4	99.1
C-L	3	17	26.5	327	117.2	553	118.0	655	118.3	930	118.8	113.3
C-M	3	18	26.4	327	119.8	553	120.6	655	120.9	930	121.4	117.6
C-MRD	3	18	26.4	327	125.2	553	125.4	655	125.5	930	125.7	118.1
C-N	3	18	26.4	327	125.2	553	125.4	655	125.5	930	125.7	117.7
C-O	3	18	26.4	327	125.3	553	125.6	655	125.8	930	126.1	119.2
C-P	3	18	26.4	327	126.3	553	126.9	655	127.2	930	127.6	122.3
C-Q	3	18	26.4	327	131.9	553	132.5	655	132.9	930	133.5	129.8
C-R	3	18	26.4	327	148.4	553	148.8	655	148.9	930	149.2	147.3
C-SRD	3	18	26.4	327	154.4	553	155.2	655	155.2	930	155.4	147.4
C-T	3	18	26.4	327	154.4	553	155.2	655	155.3	930	155.5	147.5
C-U	3	18	26.4	327	161.2	553	162.0	655	162.2	930	162.7	158.5
C-V	4	18	26.4	327	165.4	553	165.7	655	165.7	930	166.0	163.5
C-W	4	18	26.4	327	171.6	553	172.5	655	172.8	930	173.4	168.5
C-X	4	18	26.4	327	181.1	553	181.9	655	182.2	930	182.7	178.5
C-Y	4	19	26.4	327	202.2	553	203.1	655	203.3	930	204.2	199.6
C-Z	4	19	26.4	327	225.0	553	225.9	655	226.2	930	226.9	222.3

Table I Present Conditions: Frequency-Discharge-Elevation Data at Valley Sections Wasilla, Cottonwood, Lucile Creeks, and Kashwitna River Susitna River Basin

Valley Section	Photo-Map (No.)	Profile Sheet (No.)	Drainage Area (Sq. Mi.)	10-Year Storm		50-Year Storm		100-Year Storm		500-Year Storm		Channel Bottom
				Disch. (cfs)	Elev. msl (feet)	Disch. (cfs)	Elev. msl (feet)	Disch. (cfs)	Elev. msl (feet)	Disch. (cfs)	Elev. msl (feet)	Elev. msl (feet)
C-AARD	4	19	26.4	327	230.4	553	230.6	655	230.6	930	230.9	225.7
C-AB	4	19	26.4	327	230.4	553	230.6	655	230.7	930	231.0	223.2
C-AC	4	19	26.4	327	231.6	553	232.3	655	232.6	930	233.2	227.4
C-AD	4	19	26.4	327	233.5	553	234.5	655	234.7	930	235.3	230.5
C-AE	4	20	26.4	327	238.3	553	239.1	655	239.4	930	239.9	236.1
C-AF	4	20	26.4	327	245.4	553	246.5	655	246.9	930	247.6	242.3
C-AG	4	20	26.4	327	250.2	553	251.2	655	251.6	930	252.3	247.3
C-AH	4	20	26.4	327	252.1	553	253.2	655	253.6	930	254.4	249.2
C-AI	5	20	26.4	327	253.8	553	254.8	655	255.0	930	255.7	250.5
C-AJRD	5	20	19.3	220	254.3	372	255.0	440	255.3	622	255.9	251.0
C-AK	5	20	19.3	220	254.3	372	255.1	440	255.3	622	256.0	250.6
C-AL	5	20	19.3	220	255.6	372	256.5	440	256.8	622	257.4	253.2
C-AM	5	21	19.3	220	261.6	372	262.3	440	262.7	622	263.4	259.3
C-AN	5	21	19.3	220	270.3	372	271.2	440	271.4	622	272.0	268.0
C-AO	5	21	19.3	220	280.2	372	280.7	440	280.9	622	281.2	279.0
C-AP	5	21	19.3	220	282.6	372	283.2	440	283.4	622	284.0	280.8
C-AQRD	5	22	19.3	220	284.5	372	284.7	440	284.8	622	284.9	281.8
C-AR	5	22	19.3	220	284.5	372	284.8	440	284.9	622	285.1	281.6
C-AS	5	22	19.3	220	286.7	372	287.6	440	287.7	622	288.5	284.1
C-AT	6	22	19.3	220	289.7	372	290.6	440	290.9	622	291.6	287.0
C-AU	6	22	19.3	220	295.4	372	296.4	440	296.6	622	297.3	293.0
C-UA	6	23	19.3	220	298.4	372	299.4	440	299.7	622	300.6	295.3
C-AVRD	6	23	19.3	220	305.9	372	310.1	440	310.1	622	310.2	296.1
C-AW	6	23	19.3	220	305.9	372	310.1	440	310.1	622	310.2	295.6
C-AX	6	23	19.3	220	306.0	372	310.1	440	310.1	622	310.2	298.5
C-AY	6	23	19.3	220	307.4	372	310.3	440	310.4	622	310.6	304.6
C-AZRR	6	23	19.3	220	307.6	372	310.4	440	310.4	622	310.7	304.9

Table 1 Present Conditions: Frequency-Discharge-Elevation Data at Valley Sections Wasilla, Cottonwood, Lucile Creeks, and Kashwitna River Susitna River Basin

Valley Section	Photo-Map (No.)	Profile Sheet (No.)	Drainage Area (Sq. Mi.)	10-Year Storm		50-Year Storm		100-Year Storm		500-Year Storm		Channel Bottom
				Disch. (cfs)	Elev. msl (feet)	Disch. (cfs)	Elev. msl (feet)	Disch. (cfs)	Elev. msl (feet)	Disch. (cfs)	Elev. msl (feet)	Elev. msl (feet)
C-BA	6	23	19.3	220	307.8	372	310.4	440	310.5	622	310.8	305.1
C-BB	6	23	15.5	183	308.3	308	310.6	365	310.7	516	311.1	306.0
C-BCRD	6	23	15.5	183	310.1	308	311.4	365	311.8	516	312.5	306.3
C-BD	6	23	15.5	183	310.1	308	311.4	365	311.8	516	312.5	306.6
C-BE	6	23	15.5	183	312.9	308	313.6	365	313.9	516	314.5	309.5
C-BF	6	23	15.5	183	313.0	308	313.8	365	314.1	516	314.6	310.7
C-BGHY	6	23	15.5	183	318.8	308	325.4	365	325.7	516	326.1	311.0
C-BH	6	23	15.5	183	318.8	308	325.4	365	325.7	516	326.1	310.9
C-BI	6	23	15.5	183	318.8	308	325.4	365	325.7	516	326.1	311.9
C-BJ	6	24	15.5	183	318.8	308	325.4	365	325.7	516	326.1	314.0
C-BK	7	24	5.6	79	318.9	133	325.4	158	325.7	223	326.1	315.0
C-BL	7	24	5.6	79	318.9	133	325.4	158	325.7	223	326.1	315.9
C-BMRD	7	24	5.6	79	321.3	133	325.4	158	325.7	223	326.1	317.0
C-BN	7	24	5.6	79	321.3	133	325.4	158	325.7	223	326.1	317.0
C-BP	7	25	5.6	79	321.3	133	325.4	158	325.7	223	326.1	319.1
C-BQ	7	25	5.6	220	323.4	372	325.6	440	325.9	622	326.4	322.1
C-BRRD	7	25	5.6	220	330.1	372	330.4	440	330.5	622	330.7	322.3
C-BS	8	25	5.6	220	330.1	372	330.4	440	330.5	622	330.7	322.3
C-BT	8	26	5.6	220	330.1	372	330.5	440	330.5	622	330.8	323.1 T/
C-BU	8	26	18.6	220	330.2	372	330.6	440	330.7	622	331.1	323.7 T/
C-BV	8	26	15.0	183	331.3	308	332.1	365	332.5	516	333.1	325.4 T/
C-BW	8	27	8.1	115	375.6	194	376.1	230	376.3	325	376.7	373.5 T/
C-BXRD	8	27	8.1	115	381.0	194	382.6	230	382.8	325	383.1	376.0 T/
C-BY	8	27	8.1	115	381.4	194	382.8	230	383.1	325	383.5	375.7 T/
C-BZ	8	27	8.1	115	395.1	194	395.8	230	396.0	325	396.4	292.1 T/

I/Elevations and distances associated with these cross sections taken from USGS quadrangles, Anchorage C-7 SE, Scale 1:25,000, contour interval 5 meters.

Table 1 Present Conditions: Frequency-Discharge-Elevation Data at Valley Sections Wasilla, Cottonwood, Lucile Creeks, and Kashwitna River Susitna River Basin

Valley Section	Photo-Map (No.)	Profile Sheet (No.)	Drainage Area (Sq. Mi.)	10-Year Storm		50-Year Storm		100-Year Storm		500-Year Storm		Channel Bottom
				Disch. (cfs)	Elev. ms1 (feet)	Disch. (cfs)	Elev. ms1 (feet)	Disch. (cfs)	Elev. ms1 (feet)	Disch. (cfs)	Elev. ms1 (feet)	Elev. ms1 (feet)
<u>Wasilla Creek</u>												
WA-A	9	6	44.0	680	21.0	890	22.0	1010	22.5	1390	23.0	19.0
WA-B	9	6	43.8	680	27.8	890	28.2	1010	28.4	1390	29.0	24.0
WA-C	9	6	43.5	680	33.9	890	34.6	1010	34.9	1390	35.7	29.5
WA-D	9	6	43.3	680	38.6	890	39.1	1010	39.3	1390	40.0	34.5
WA-E	9	6	43.2	680	48.0	890	48.5	1010	48.8	1390	49.4	44.5
WA-F	9	6	43.0	680	62.6	890	63.1	1010	63.3	1390	64.1	59.0
WA-G	9	6	42.9	680	79.8	890	80.2	1010	80.4	1390	80.8	76.5
WA-H	9	7	42.8	680	96.8	890	97.1	1010	97.2	1390	97.7	94.0
WA-I	9	7	42.7	680	112.1	890	112.4	1010	112.6	1390	113.0	109.0
WA-J	9	7	42.5	680	127.3	890	127.7	1010	127.7	1390	128.4	123.7
WA-KRR	9	7	42.4	680	129.5	890	130.5	1010	131.2	1390	133.0	124.5
WA-L	9	7	41.9	680	129.7	890	130.6	1010	131.2	1390	133.0	125.4
WA-M	9	7	41.4	680	130.3	890	130.9	1010	131.4	1390	133.1	126.9
WA-NHY	9	7	41.0	680	131.4	890	131.9	1010	132.1	1390	133.2	128.4
WA-O	9	7	40.5	680	133.2	890	133.8	1010	134.2	1390	135.2	129.0
WA-P	10	8	39.5	680	143.0	890	143.4	1010	143.6	1390	144.1	140.0
WA-Q	10	8	39.0	680	156.4	890	156.8	1010	156.9	1390	157.3	153.1
WA-RRD	10	8	38.5	680	158.1	890	158.1	1010	158.1	1390	158.4	154.2
WA-S	10	8	38.0	680	158.3	890	158.4	1010	158.5	1390	158.8	154.7
WA-T	10	8	37.4	680	162.8	890	163.0	1010	163.2	1390	163.7	157.4
WA-U	10	8	36.9	680	167.3	890	167.6	1010	167.7	1390	168.2	163.4
WA-V	10	9	36.3	680	181.6	890	182.0	1010	182.1	1390	182.5	177.8
WA-WRD	10	9	35.8	680	182.8	890	183.1	1010	183.2	1390	183.7	179.5
WA-X	10	9	35.3	680	184.6	890	184.7	1010	184.9	1390	185.1	181.0
WA-Y	10	9	34.8	680	192.0	890	192.2	1010	192.5	1390	192.9	188.0
WA-Z	10	9	34.3	680	201.6	890	202.0	1010	202.3	1390	202.7	198.0

Table 1 Present Conditions: Frequency-Discharge-Elevation Data at Valley Sections Wasilla, Cottonwood, Lucile Creeks, and Kashwitna River Susitna River Basin

Valley Section	Photo-Map (No.)	Profile Sheet (No.)	Drainage Area (Sq. Mi.)	10-Year Storm		50-Year Storm		100-Year Storm		500-Year Storm		Channel Bottom
				Disch. (cfs)	Elev. msl (feet)	Disch. (cfs)	Elev. msl (feet)	Disch. (cfs)	Elev. msl (feet)	Disch. (cfs)	Elev. msl (feet)	Elev. msl (feet)
WA-BA	13	15	19.7	480	477.0	620	477.1	710	477.4	980	477.7	473.8
WA-BB	13	16	18.7	480	481.6	620	481.8	710	482.0	990	482.4	478.8
WA-BC	13	16	17.7	370	483.1	480	483.4	550	483.7	760	484.0	481.2
WA-BDHY	13	16	16.7	370	487.4	480	488.6	470	489.3	650	492.3	481.5
WA-BE	13	16	16.7	310	487.4	410	488.6	470	489.3	650	492.3	481.8
WA-BF	13	16	16.7	310	491.7	410	492.5	470	492.8	650	493.7	488.8
<u>Lucile Creek 2/</u>												
L-A	14	28	15.2	220	176.2	380	176.4	468	176.6	700	177.1	173.6
L-B	14	28	15.2	220	176.3	380	176.5	468	176.7	700	177.2	174.2
L-C	14	28	15.2	220	176.3	380	176.5	468	176.7	700	177.2	174.7
L-DRD	14	28	15.2	220	180.0	380	180.1	468	180.2	700	180.3	175.0
L-E	14	28	15.2	220	180.0	380	180.2	468	180.3	700	180.5	175.9
L-F	14	28	15.2	220	190.6	380	191.0	468	191.1	700	191.5	187.5
L-G	14	28	15.2	220	203.2	380	203.8	468	203.9	700	204.3	200.0
L-H	14	29	15.2	220	216.4	380	216.8	468	217.1	700	217.6	213.3
L-I	14	29	15.2	220	230.8	380	231.4	468	231.6	700	232.0	228.0
L-J	14	30	15.2	220	253.7	380	254.1	468	254.4	700	254.8	250.0
L-K	14	30	15.2	220	256.5	380	257.2	468	257.3	700	257.9	252.6
L-L	14	30	15.2	220	258.3	380	258.7	468	258.9	700	259.2	254.9
L-M	14	31	15.2	220	261.2	380	261.6	468	261.8	700	262.3	257.2
L-N	14	31	15.2	220	264.4	380	264.9	468	265.1	700	265.4	260.4

2/Elevations for cross sections L-A through L-AC are estimated from USGS quadrangles, 15 minute, scale 1:63,360, with 50 foot contours.

Table 1 Present Conditions: Frequency-Discharge-Elevation Data at Valley Sections Wasilla, Cottonwood, Lucile Creeks, and Kashwitna River Susitna River Basin

Valley Section	Photo-Map (No.)	Profile Sheet (No.)	Drainage Area (Sq. Mi.)	10-Year Storm		50-Year Storm		100-Year Storm		500-Year Storm		Channel Bottom
				Disch. (cfs)	Elev. msl (feet)	Disch. (cfs)	Elev. msl (feet)	Disch. (cfs)	Elev. msl (feet)	Disch. (cfs)	Elev. msl (feet)	Elev. msl (feet)
L-O	14	32	15.2	220	266.4	380	266.8	468	267.0	700	267.4	263.2
L-P	14	32	9.5	170	270.1	296	270.7	360	271.0	540	271.2	265.9
L-Q	14	33	9.5	170	273.3	296	273.7	360	273.9	540	274.1	269.4
L-R	14	33	9.5	170	274.7	296	275.0	360	275.0	540	275.2	271.3
L-S	14	33	9.5	170	279.1	296	279.8	360	280.0	540	280.5	275.0
L-T	14	34	9.5	170	281.7	296	282.6	360	282.8	540	283.4	277.3
L-U	14	34	9.5	170	284.1	296	284.8	360	285.0	540	285.7	280.0
L-V	15	34	9.5	170	286.3	296	287.0	360	287.2	540	287.8	282.5
L-W	15	35	9.5	170	288.5	296	289.2	360	289.5	540	290.1	284.8
L-X	15	35	9.5	170	290.5	296	291.1	360	291.2	540	291.7	287.1
L-Y	15	35	4.6	62	292.4	106	293.1	128	293.5	192	293.9	289.4
L-Z	15	36	4.6	62	294.5	106	295.3	128	295.5	192	295.7	291.7
L-AA	15	36	4.6	62	296.2	106	296.8	128	297.0	192	297.5	293.3
L-AB	15	36	4.6	62	297.4	106	298.0	128	298.1	192	298.6	294.2
L-AC	15	36	4.6	62	298.0	106	298.4	128	298.5	192	298.9	295.0
L-AD	16	37	4.6	62	302.3	106	303.0	128	303.2	192	303.5	300.0
L-AE	16	37	4.6	62	308.6	106	309.2	128	309.4	192	310.0	307.0
L-AF	16	37	4.6	62	312.2	106	312.3	128	312.4	192	312.6	310.5
L-AG	16	37	4.6	62	312.7	106	312.9	128	313.0	192	313.4	311.0
L-AH	16	37	2.3	30	313.8	53	314.2	65	314.4	96	314.8	312.0

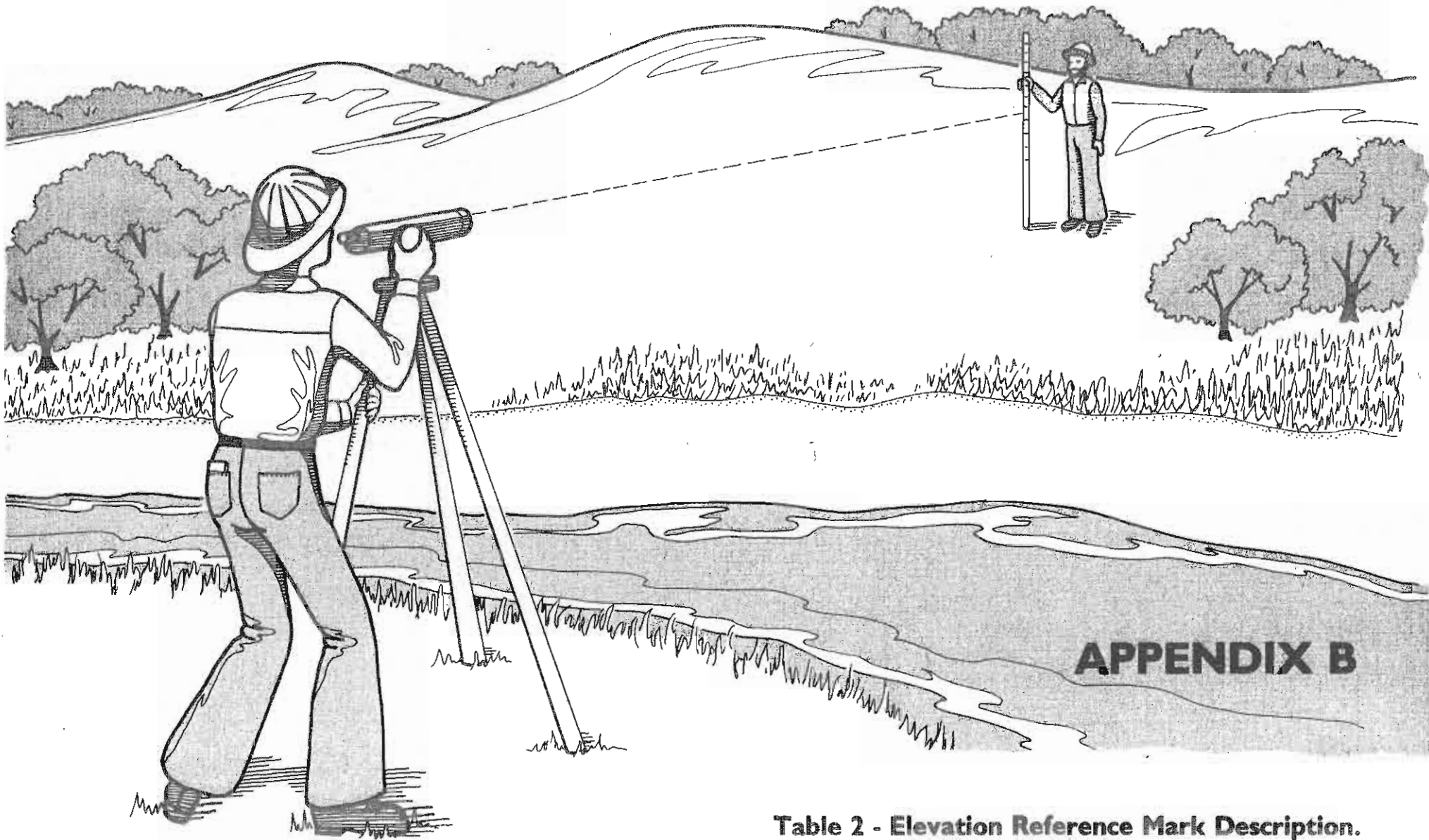

Table 2 - Elevation Reference Mark Description.

**TABLE 2 ELEVATION REFERENCE MARK DESCRIPTION
KASHWITNA RIVER -
WASILLA, COTTONWOOD, AND LUCILE CREEKS**

BM NO.	PHOTO SHEET NO.	MEAN SEA LEVEL ELEVATION (FEET)	DESCRIPTION AND LOCATION
TBM C-1	6 & 17	363.665	60d spike in 10 inch birch tree 75 feet west of Knik-Goose Bay Road and 100 feet north of the north entrance to Century Park Subdivision.
TBM C-2	5	312.93	60d spike in 8 inch birch tree at the westerly treeline at Mile 1.2 of Knik-Goose Bay Road and 430 feet south of the transmission line crossing.
TBM C-3	5	293.705	60d spike in 5 inch birch tree in treeline on the east side of Mile 2.09 of Knik-Goose Bay Road and 385 feet southerly of the entrance to the Matanuska-Susitna Borough Landfill.
TBM C-4	4 & 5	298.15	60d spike in 8 inch birch tree at westerly treeline of Knik-Goose Bay Road and 450 feet west of intersection with Edlund Road.
TBM C-5	4	317.675	Chisled "X" on the top of the upstream end of a 24 inch corrugated metal pipe on the north side of Knik-Goose Bay Road. It is also 350 feet westerly of Mile 3 of the said road and the first culvert under Knik-Goose Bay Road westerly of Lakewood Road.
TBM C-6		337.06	60d spike in 6 inch birch tree 10 feet inside treeline on the west side of Knik-Goose Bay Road at Mile 3.55.
TBM C-7		296.47	60d spike in 12 inch birch tree in the southwest quadrant of the intersection of Knik-Goose Bay Road and Fairview Loop Road.
TBM C-8		253.67	60d spike in power pole on the west side of Fairview Loop Road and 1.0 mile south of its intersection with Knik-Goose Bay Road.

**TABLE 2 ELEVATION REFERENCE MARK DESCRIPTION
KASHWITNA RIVER -
WASILLA, COTTONWOOD, AND LUCILE CREEKS**

BM NO.	PHOTO SHEET NO.	MEAN SEA LEVEL ELEVATION (FEET)	DESCRIPTION AND LOCATION
TBM C-9		224.13	60d spike in power pole on the east side of Fairview Loop Road and 1.0 mile south of its intersection with Knik-Goose Bay Road.
TBM C-10		192.26	60d spike in 8 inch birch tree on the west side of Fairview Loop Road and 1.5 miles from its intersection with Knik-Goose Bay Road.
TBM C-11	3	132.95	60d spike in power pole number 28 in the southeast quadrant of the intersection of Hayfield Road and Fairview Loop Road.
TBM C-12		133.91	60d spike in 9 inch birch tree on the south side of Fairview Loop Road and 0.5 miles east of its intersection with Hayfield Road.
TBM C-13	3	130.50	Hub in open area 100 feet north of Fairview Loop Road and 0.85 miles east of Hayfield Road.
TBM C-14	3	106.97	60d spike in 6 inch birch tree at treeline on easterly side of Hayfield Road and 0.5 miles south of Fairview Loop Road.
TBM C-15	3	91.50	60d spike in 7 inch birch tree at treeline on west side of Hayfield Road and 0.75 miles south of Fairview Loop Road.
TBM C-16		138.84	60d spike in 8 inch spruce tree 0.5 miles west of the intersection of Fairview Loop Road and Hayfield Road and on the south clearing line of transmission line.
TBM C-17		169.71	60d spike in power pole at top of hill 0.7 miles west along-section line from intersection of Fairview Loop Road and Hayfield Road.

**TABLE 2 ELEVATION REFERENCE MARK DESCRIPTION
KASHWITNA RIVER -
WASILLA, COTTONWOOD, AND LUCILE CREEKS**

BM NO.	PHOTO SHEET NO.	MEAN SEA LEVEL ELEVATION (FEET)	DESCRIPTION AND LOCATION
TBM C-18		138.86	60d spike in 8 inch spruce tree 150 feet east and 150 feet south of bench mark number C-17.
TBM C-19	5	264.62	60d spike in power pole on south side of Edlund Road and 0.5 miles southerly of its intersection with Knik-Goose Bay Road.
TBM C-20		256.16	60d spike in 8 inch birch tree on south side of Edlund Road and 1.0 mile southerly of its intersection with Knik-Goose Bay Road.
TBM C-21		221.65	60d spike in 5 inch spruce tree 60 feet southwesterly of Edlund Road and 1.2 miles southerly of its intersection with Knik-Goose Bay Road. It is also 100 feet past the point of tangency of a curve to the right when south bound on Edlund Road.
TBM C-22	17	337.23	Top of east bolt on light standard, painted orange, in southwest quadrant of the intersection of Bogard Road and Wasilla-Fishhook Road.
TBM C-23		366.61	Top of north bolt on a light standard, which is opposite of power pole number TL/106/WE/20, in southeast quadrant of the intersection of Bogard Road and Crusey Street.
TBM C-24		366.61	60d spike in power pole number TL/116/WE/28 on the north side of Bogard Road and 1.0 mile easterly from its intersection with Wasilla-Fishhook Road. It is also in the northwest quadrant of the intersection of Bogard Road and an unnamed road to the north.

**TABLE 2 ELEVATION REFERENCE MARK DESCRIPTION
KASHWITNA RIVER -
WASILLA, COTTONWOOD, AND LUCILE CREEKS**

BM NO.	PHOTO SHEET NO.	MEAN SEA LEVEL ELEVATION (FEET)	DESCRIPTION AND LOCATION
TBM C-25	7	397.43	60d spike in power pole number TL/122/WE/35 on the north side of Bogard Road and 1.5 miles easterly of its intersection with Wasilla-Fishhook Road.
TBM C-26	7	409.38	60d spike in power pole number TL/128/WE/03 on the north side of Bogard Road and 2.0 miles easterly of its intersection with Wasilla-Fishhook Road.
TBM C-27	7	404.11	60d spike in power pole number TL/135/WE/50 on the north side of Bogard Road and is first power pole east of an unnamed gravel road to the north (unnamed road is 2.5 miles easterly along Bogard Road from its intersection with Wasilla-Fishhook Road).
TBM C-28	6 & 17	333.84	60d spike in power pole northeast of cul-de-sac at the end of Railroad Avenue. The cul-de-sac is directly east of the intersection of Railroad Avenue and Wasilla Street.
TBM C-29	6	317.47	60d spike in 8 inch birch tree in the treeline on the north side of Hanson Trail and 50 feet west of Matanuska Road.
TBM C-30	6	327.20	Southeast bolt on light standard in northwest quadrant of the intersection of the Palmer-Wasilla Highway with the Parks Highway.
TBM C-31	7	323.76	Chisled "X" on the west end of a corrugated metal pipe under the Palmer-Wasilla Highway at the mouth of Cottonwood Creek and the outfall of Wasilla Lake.

**TABLE 2 ELEVATION REFERENCE MARK DESCRIPTION
KASHWITNA RIVER -
WASILLA, COTTONWOOD, AND LUCILE CREEKS**

BM NO.	PHOTO SHEET NO.	MEAN SEA LEVEL ELEVATION (FEET)	DESCRIPTION AND LOCATION
TBM C-32	7	354.36	60d spike in power pole number WL/113 southerly of the Palmer-Wasilla Highway at Mile 14.9 and opposite a private driveway to the west.
TBM C-33		367.495	60d spike in power pole on the south side and 100 feet east from the field line on the north side of the Palmer-Wasilla Highway. It is also 1.9 miles northeasterly from the Parks Highway and Palmer-Wasilla Highway intersection.
TBM C-34		372.41	60d spike in 10 inch birch tree located at treeline of field to the north of the Palmer-Wasilla Highway. The tree is on the northerly side of a trail into the forest and 175 feet northeast from the corner of the field. The field is adjacent to Bench Mark C-33.
TBM C-35		366.66	Railroad spike in power pole on Mack Road 0.5 miles north of the intersection with the Knik-Goose Bay Road. The power pole is between two travel lanes.
TBM C-36		420.89	16d nail in west side of power pole number K60/11 at the north end of Mack Road. It is the last power pole and 0.65 miles north of the Knik-Goose Bay Road.
TBM C-37	7	393.71	60d spike in power pole number TL/141/WE/56 on the north side of Bogard Road and 3.0 miles easterly of Wasilla-Fishhook Road and the first power pole west of the entrance to "Alaska Army National Guard Alcantra Armory."

**TABLE 2 ELEVATION REFERENCE MARK DESCRIPTION
KASHWITNA RIVER -
WASILLA, COTTONWOOD, AND LUCILE CREEKS**

BM NO.	PHOTO SHEET NO.	MEAN SEA LEVEL ELEVATION (FEET)	DESCRIPTION AND LOCATION
TBM C-38		335.15	Railroad spike in 8 inch birch tree at the end of a one lane road going south from Bogard Road and first road east of the entrance to "Alaska Army National Guard Alcantra Armory."
TBM C-39	3	74.00	Nail in 12 inch birch tree north 30 degrees west of a turnaround at the top of a hill preceding creek with impassable bridge and 0.75 miles east of Lucy Lake.
TBM C-40		162.90	Nail in 8 inch birch tree 130 feet northeast of the control point number 332 and on the east side of a trail preceding north along the section line between sections 35 and 36, T17N, R1W, SM.
TBM WC-1	10	166.60	Top of Brass cap monument of south side of Hyer Road located 30 feet south of the east 1/16 corner common to sections 8 and 17, T17N, R1W, Seward Meridian.
TBM WC-2	10	185.98	Chisled "X" on east end of 7 feet x 6 feet corrugated metal pipe under Hyer Road at the intersection with Wasilla Creek.
TBM WC-3	10	207.47	60d spike in 7 inch birch tree 30 feet east of Hyer Road and southerly of the intersection with Wilderness Acres Subdivision entrance on the easterly side of Hyer Road. Wilderness Acres Subdivision entrance is at ninety degree curve to the left when northbound on Hyer Road. The spike is 3.2 feet above ground.

**TABLE 2 ELEVATION REFERENCE MARK DESCRIPTION
KASHWITNA RIVER -
WASILLA, COTTONWOOD, AND LUCILE CREEKS**

BM NO.	PHOTO SHEET NO.	MEAN SEA LEVEL ELEVATION (FEET)	DESCRIPTION AND LOCATION
TBM WC-4		305.37	60d spike in power pole number WL/76 on west side of Hyer Road and 150 feet south of its intersection with Upper Court Road. The spike is 2.0 feet above ground.
TBM WC-5		349.75	60d spike in power pole number WL/79/2 in the southeast quadrant of the intersection of Hyer Road with the Palmer-Wasilla Highway. The spike is 3.0 feet above ground.
TBM WC-6		369.64	60d spike in fifth power pole (Matanuska Electric Association Station 68 + 79.9) east of the intersection of Hyer Road with the Palmer-Wasilla Highway. It is also the first power pole west of Mile 12 of the Palmer-Wasilla Highway. The spike is 2.6 feet above ground.
TBM WC-7		385.18	60d spike in a power pole on the Palmer-Wasilla Highway 0.3 miles east of its intersection with Hyer Spur Road. The spike is 0.2 feet above ground.
TBM WC-8		368.08	Railroad spike in the centerline of the Palmer-Wasilla Highway 1.4 miles west of its intersection with Matanuska Trunk Road and at the entrance to the gravel pit in Section 4, T17N, R1E, Seward Meridian.
TBM WC-9	11	338.16	Railroad spike in the centerline of the Palmer-Wasilla Highway and 600 feet east of the entrance to Finger Lake Subdivision.
TBM WC-10	12	339.94	60d spike in 6 inch birch tree in northeast quadrant of the intersection of Green Forest Drive and the Palmer-Wasilla Highway. It is also northerly of a double birch tree.

**TABLE 2 ELEVATION REFERENCE MARK DESCRIPTION
KASHWITNA RIVER -
WASILLA, COTTONWOOD, AND LUCILE CREEKS**

BM NO.	PHOTO SHEET NO.	MEAN SEA LEVEL ELEVATION (FEET)	DESCRIPTION AND LOCATION
TBM WC-11	12	298.61	60d spike in power pole number WA/673 in front of the "Union 76" Service Station on the Palmer-Wasilla Highway and 0.2 miles west of its intersection with the Matanuska Trunk Road.
TBM WC-12		301.54	60d spike in power pole in southeast quadrant of the intersection of the Palmer-Wasilla Highway with the Matanuska Trunk Road.
TBM WC-12A	12	318.50	60d spike in power pole number WA/73 on the west side of the Matanuska Trunk Road and 0.5 miles north of its intersection with the Palmer-Wasilla Highway. The spike is 2.0 feet above ground.
TBM WC-13	12	337.37	60d spike in power pole number W/81 on the west side of the Matanuska Trunk Road and 0.12 miles south of its intersection with Bogard Road.
TBM WC-14	12	363.50	60d spike in power pole on the east side of the Matanuska Trunk Road and 0.25 miles north of its intersection with Bogard Road. The power pole is the sixth one north of Bogard Road.
TBM WC-15	12 & 13	395.67	60d spike 225 feet north of Milepost 5 of the Matanuska Trunk Road in the northerly post of an entrance to a field on the west side of the Matanuska Trunk Road.
TBM WC-16	13	424.81	60d spike in 8 inch birch tree at the easterly treeline of the Matanuska Trunk Road at Mile 5.5 and 100 feet northerly of the beginning of a curve to the left when going northerly on the Matanuska Trunk Road.

**TABLE 2 ELEVATION REFERENCE MARK DESCRIPTION
KASHWITNA RIVER -
WASILLA, COTTONWOOD, AND LUCILE CREEKS**

BM NO.	PHOTO SHEET NO.	MEAN SEA LEVEL ELEVATION (FEET)	DESCRIPTION AND LOCATION
TBM WC-17	13	451.12	60d spike in 8 inch birch tree on easterly treeline 390 feet northerly of Milepost 6 of the Matanuska Trunk Road.
TBM WC-18		454.96	Chisled "X" 32 feet northerly of the Matanuska Trunk Road on top of a 12 inch corrugated metal pipe at the intersection with Fishhook-Willow Road.
TBM WC-19		483.39	60d spike in power pole number FH/39 in the gravel parking area of the "Fishhook Dairy" and 125 feet westerly of the centerline of the Fishhook-Willow Road. It is also 275 feet southerly of Milepost 3 of the Matanuska Trunk Road. The spike is 1.0 feet above ground.
TBM WC-20		505.93	60d spike in power pole 114 feet westerly of the centerline of the Fishhook-Willow Road and 150 feet southerly of Star Route A 4967 (mailbox of the Ybarra Homestead).
TBM WC-21		539.33	60d spike in 10 inch birch tree on the north side of gravel road 0.14 miles west from the intersection with Fishhook-Willow Road. The gravel road begins 1.1 miles north of the intersection of Fishhook-Willow and Matanuska Trunk Road intersection.
TBM WC-22		561.89	60d spike in a power pole 42 feet northwesterly of a gravel road 0.19 miles west from its intersection with Fishhook-Willow Road. The gravel road begins 1.1 miles north of the intersection of Fishhook-Willow and Matanuska Trunk Road intersection.
TBM WC-23		383.03	60d spike in 3 inch birch tree on the north side of Griffith Road and 0.4 miles east of its intersection with the Matanuska Trunk Road.

**TABLE 2 ELEVATION REFERENCE MARK DESCRIPTION
KASHWITNA RIVER -
WASILLA, COTTONWOOD, AND LUCILE CREEKS**

BM NO.	PHOTO SHEET NO.	MEAN SEA LEVEL ELEVATION (FEET)	DESCRIPTION AND LOCATION
TBM WC-24		352.53	60d spike in 12 inch birch tree at the entrance to the second farm on the north side of Bogard Road. Said farm entrance is west of the intersection of Bogard Road and the Matanuska Trunk Road.
TBM WC-25		405.60	60d spike in power pole number WA/96/A in the southwest quadrant of the intersection of Engstrom Drive and Sebastion Drive.
TBM WC-26		207.77	60d spike in the west post of the entrance to the gravel pit on the southerly side of the Parks Highway. The gravel pit is 0.5 miles easterly of the intersection of Hyer Road and Parks Highway. The spike is at ground level.
TBM WC-27		177.40	Chisled "X" on top of the west end of an 18 inch metal pipe under Pioneer Drive at the intersection with the Parks Highway.
TBM WC-28		174.38	60d spike in power pole/transformer number WL/253, 100 feet south of the Parks Highway and 730 feet east of Jensen Road.
TBM WC-29		351.36	60d spike in 10 inch birch tree 70 feet south of the centerline of the Palmer-Wasilla Highway and 0.5 miles west of its intersection with Hyer Road. It is also 200 feet east of the entrance to Yadon Acres Subdivision. The spike is 2.0 feet above ground.
TBM WC-30		371.53	60d spike in fence corner post 32 feet south of the Palmer-Wasilla Highway and 1.0 mile west of its intersection with Hyer Road.

**TABLE 2 ELEVATION REFERENCE MARK DESCRIPTION
KASHWITNA RIVER -
WASILLA, COTTONWOOD, AND LUCILE CREEKS**

BM NO.	PHOTO SHEET NO.	MEAN SEA LEVEL ELEVATION (FEET)	DESCRIPTION AND LOCATION
TBM WC-31		330.58	60d spike in 10 inch birch tree east of a small knoll and southeast of the Yadon Acres Subdivision playground. The spike is 2.5 feet above ground.
TBM WC-32		87.74	60d spike in 8 inch birch tree located in uncultivated area between two hay fields near west 1/4 corner of Section 20, T17N, R1E, Seward Meridian.
TBM WC-33		66.97	60d spike in flag type railroad crossing marker marked with Department of Transportation Inventory Number 878312H on the west side of the intersection with a private road in the northwest 1/4 of Section 21, T17N, R1E, Seward Meridian.
TBM K-1	1	207.83	60d spike in tenth power pole on easterly side of Parks Highway and northerly of the bridge over Kashwitna River. The spike is 2.3 feet above ground.
TBM K-2	1	210.34	60d spike in 3 inch birch tree on the northerly side of Susitna Landing Road and 0.4 miles westerly of the intersection with the Parks Highway.
TBM K-3	1	153.06	60d spike in 12 inch birch tree on south side at the west end of Susitna Landing Road, located in Section 13, T21N, R5W, Seward Meridian.

**TABLE 2 ELEVATION REFERENCE MARK DESCRIPTION
KASHWITNA RIVER -
WASILLA, COTTONWOOD, AND LUCILE CREEKS**

BM NO.	PHOTO SHEET NO.	MEAN SEA LEVEL ELEVATION (FEET)	DESCRIPTION AND LOCATION
TBM K-4	1	154.41	60d spike in 14 inch birch tree located at treeline on the east bank of the Susitna River and 100 feet southerly of a sandy gradually sloping bank intersecting a 1:1 gravel bank. Located in Section 13, T21N, R5W, Seward Meridian.
TBM K-5	2	197.18	60d spike in power pole on easterly side of the Parks Highway at Mile 83.8.
TBM K-6		210.52	60d spike in power pole on northerly side of the Parks Highway at Mile 84.3.
TBM K-7		219.19	60d spike in second telegraph pole southerly of railroad Milepost 200.
TBM K-8		222.01	60d spike in tenth telegraph pole northerly of railroad Milepost 200.
TBM K-9	2	208.56	60d spike in telegraph pole on north side of a trail to the east at railroad Mile 199.85.
TBM K-10	2	199.28	60d spike in railroad sign with "W" on it at railroad Mile 199.45. It is also northerly of railroad bridge across Kashwitna River.
TBM K-11	2	203.96	60d spike in 8 inch spruce tree on northerly side of Kashwitna River, midway in river bend (bend is in Section 32, T22N, R4W, SM) and 200 feet south of control point number 345.

**TABLE 2 ELEVATION REFERENCE MARK DESCRIPTION
KASHWITNA RIVER -
WASILLA, COTTONWOOD, AND LUCILE CREEKS**

BM NO.	PHOTO SHEET NO.	MEAN SEA LEVEL ELEVATION (FEET)	DESCRIPTION AND LOCATION
TBM K-12	2	210.24	60d spike in a stump located in Section 33, T22N, R4W, Seward Meridian and 10 feet east of control point number 346.
TBM L-1	16	334.38	60d spike in power pole 125 feet north of a curve to the right when northbound on the Parks Highway and south of the "Spenard Building Supplies" building. The power pole is also a point of intersection pole.
TBM L-2	16	326.96	60d spike in power pole number WB/25/4/1 on the west side of Lucile Lane and 100 feet south of its intersection with Lucile Avenue.
TBM L-3		346.64	Nail in power pole on the northerly side at Mile 44.75 of the Parks Highway.
TBM L-4		333.74	Nail in third telegraph pole to the west as you approach the railroad tracks from the first road on the south side of the Parks Highway westerly of Church Road.
TBM L-5	16	318.41	Railroad spike in 10 inch birch tree on the north side of a private road as it bends left and parallels Lucile Lake. The private road runs north from Knik-Goose Bay Road between Sections 16 and 17, T17N, R1W, SM.

**2 ELEVATION REFERENCE MARK DESCRIPTION
KASHWITNA RIVER -
WASILLA, COTTONWOOD, AND LUCILE CREEKS**

BM NO.	PHOTO SHEET NO.	MEAN SEA LEVEL ELEVATION (FEET)	DESCRIPTION AND LOCATION
S-1 *	17	331.935	At Wasilla, at the crossing of State Highway 3 and the Alaska Railroad, 0.05 mile west of the Railroad Station at Wasilla, 21.1 feet south of the south rail of the main track, 52 feet west of the centerline of the highway, 4.5 feet northeast of the fourth telephone pole east of Milepost 160, 36 feet north of the centerline of an east-west graveled road, 0.6 foot west of a witness post, about level with the tract, and set in the top of a concrete post 0.2 foot underground.
U-102 *		349.940	2.2 miles west along State Highway 3 from the Alaska Railroad Station at Wasilla, three power line poles east of a power line crossing, 49.5 feet north of the centerline of the highway, 1.0 foot east of power line pole W/54, 1.1 feet west of a witness post, about .5 foot lower than the highway, and a 5/8-inch copper coated rod that is driven to a depth of 12 feet and is encased in a 5-inch orangeburg pipe which projects 0.7 foot.
T-104 *		202.385	14.35 miles south along a graveled road from the Alaska Railroad Station at Talkeetna, thence 15.95 miles south along State Highway 3, about 0.7 mile south of a bridge over the Kashwitna River, 56 feet east of the centerline of the highway, 1.6 feet north of a metal witness post, about 4.5 feet lower than the highway, a disk on the top of a 5/8-inch copper coated rod that is driven to a depth of 16 feet and is encased in a 5-inch orangeburg pipe which projects 0.5 foot.

**TABLE 2 ELEVATION REFERENCE MARK DESCRIPTION
KASHWITNA RIVER -
WASILLA, COTTONWOOD, AND LUCILE CREEKS**

BM NO.	PHOTO SHEET NO.	MEAN SEA LEVEL ELEVATION (FEET)	DESCRIPTION AND LOCATION
T-102 *		153.189	0.9 mile east along the Alaska Railroad from the station at Wasilla, thence 4 miles east along a dirt road, at the junction of the Alaska Railroad, at the junction of a dirt road leading south across tracks at the crossing of a power line, 151.5 feet south of the centerline of the road, 23 feet west of the centerline of the road leading south, 58 feet southwest of and across the road from the fourth telephone pole west of Mile post 155 on railroad, 66.1 feet south of the south rail, 1 foot north of power line pole F/51, 1 foot west of a witness post, about level with the road leading south, and a 5/8-inch copper coated rod that is driven to a depth of 48 feet and is encased in a 5-inch orangeburg pipe which projects 1.0 foot.
Q-102 *		359.241	0.9 mile east along the Alaska Railroad from the station at Wasilla, thence 0.8 mile southeast along a dirt road, 0.55 mile west of a small frame house, on the outside of a curve, 200 feet west of the summit of a hill, 34 feet south of the centerline of the road, 1.5 feet north of a 10-inch tree with a triangular blaze 1.2 feet east of a witness post, about level with the road and a 5/8-inch copper coated rod that is driven to a depth of 14 feet and is encased in a 5-inch orangeburg pipe which projects 0.8 foot.
X-102 *		99.544	0.9 mile east along the Alaska Railroad from the station at Wasilla, thence 4.0 miles east along a dirt road, thence 1.15 miles east along the Alaska Railroad, on the outside of a curve, 28.8 feet southwest of the southwest rail, 21.5 feet north-northwest of the fourth telephone pole with a guy wire south of Milepost 154, 0.8 foot southeast of a witness post, about level with the track, and a 5/8-inch copper coated rod that is driven to a depth of 16 feet and is encased in a 5-inch orangeburg pipe which projects 0.7 foot.

**TABLE 2 ELEVATION REFERENCE MARK DESCRIPTION
KASHWITNA RIVER -
WASILLA, COTTONWOOD, AND LUCILE CREEKS**

BM NO.	PHOTO SHEET NO.	MEAN SEA LEVEL ELEVATION (FEET)	DESCRIPTION AND LOCATION
T-102 *		153.189	0.9 mile east along the Alaska Railroad from the station at Wasilla, thence 4 miles east along a dirt road, at the junction of the Alaska Railroad, at the junction of a dirt road leading south across tracks at the crossing of a power line, 151.5 feet south of the centerline of the road, 23 feet west of the centerline of the road leading south, 58 feet southwest of and across the road from the fourth telephone pole west of Mile post 155 on railroad, 66.1 feet south of the south rail, 1 foot north of power line pole F/51, 1 foot west of a witness post, about level with the road leading south, and a 5/8-inch copper coated rod that is driven to a depth of 48 feet and is encased in a 5-inch orangeburg pipe which projects 1.0 foot.
Q-102 *		359.241	0.9 mile east along the Alaska Railroad from the station at Wasilla, thence 0.8 mile southeast along a dirt road, 0.55 mile west of a small frame house, on the outside of a curve, 200 feet west of the summit of a hill, 34 feet south of the centerline of the road, 1.5 feet north of a 10-inch tree with a triangular blaze 1.2 feet east of a witness post, about level with the road and a 5/8-inch copper coated rod that is driven to a depth of 14 feet and is encased in a 5-inch orangeburg pipe which projects 0.8 foot.
X-102 *		99.544	0.9 mile east along the Alaska Railroad from the station at Wasilla, thence 4.0 miles east along a dirt road, thence 1.15 miles east along the Alaska Railroad, on the outside of a curve, 28.8 feet southwest of the southwest rail, 21.5 feet north-northwest of the fourth telephone pole with a guy wire south of Milepost 154, 0.8 foot southeast of a witness post, about level with the track, and a 5/8-inch copper coated rod that is driven to a depth of 16 feet and is encased in a 5-inch orangeburg pipe which projects 0.7 foot.

**TABLE 2 ELEVATION REFERENCE MARK DESCRIPTION
KASHWITNA RIVER -
WASILLA, COTTONWOOD, AND LUCILE CREEKS**

BM NO.	PHOTO SHEET NO.	MEAN SEA LEVEL ELEVATION (FEET)	DESCRIPTION AND LOCATION
U-104 [*]	1	184.20	14.35 miles south along a graveled road from the Alaska Railroad Station at Talkeetna, thence 15.3 miles south along State Highway 3, 15 feet northeast of the centerline of the highway, set in the top of the northwest end of the northeast concrete curb of the concrete bridge over the Kashwitna River, 9.2 feet southeast of the northwest end of the curb, and about 0.5 foot higher than the highway.

* National Geodetic Survey Control Bench Marks

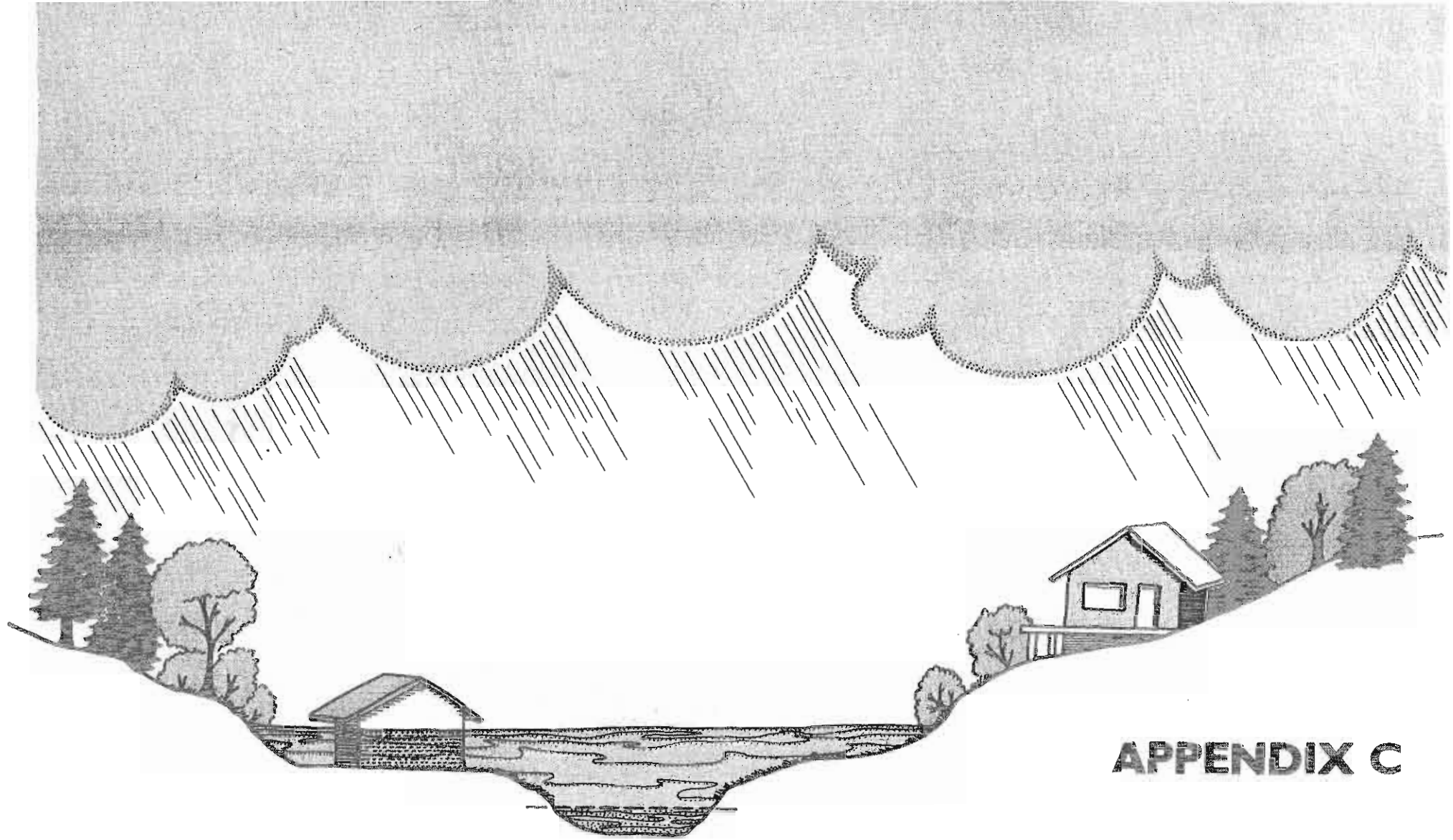

APPENDIX C

Table 3 - 100-year Flood Data

—PRESENT CONDITIONS—

Table 3 100-Year Flood Data - Present Conditions
Kashwitna River, Wasilla, Cottonwood and Lucile Creeks

Valley Section	Photo Sheet (No.)	Profile Sheet (No.)	Profile Station (feet)	Flood Widths		Average Velocity (feet/sec.)
				Distance to Left (ft.)	Distance to Right (ft.)	
<u>Kashwitna River</u>						
K-A	1	1	00		Susitna Flood Plain	
K-B	1	1	780		Susitna Flood Plain	
K-C	1	1	1778		Susitna Flood Plain	
K-D	1	1	3118	1700	300	0.7
K-E	1	1	3778	2700	30	0.7
K-F	1	1	5018	960	660	2.6
K-G	1	1	5778	1020	800	3.2
K-H	1	2	7218	350	2350	1.8
K-I	1	2	9458	350	3050	2.4
K-J	1	2	9998	400	1600	3.9
K-KHY	1	2	10078	700	1600	11.8
K-L	1	2	10118	600	1600	1.6
K-M	1	2	10598	650	2300	1.3
K-N	1	3	12038	50	3200	2.0
K-O	1	3	13958	70	2750	2.0
K-P	2	3	15358	720	2550	1.7
K-Q	2	3	15978	200	1100	3.9
K-RRR	2	3	16028	100	100	4.8
K-S	2	3	16118	350	530	3.1
K-T	2	3	17218	200	850	2.5
K-U	2	4	18618	500	990	3.0
K-V	2	4	21038	1880	100	2.4
K-W	2	4	22738	1400	460	4.2
K-Y	2	5	28258	1950	550	1.8
K-Z	2	5	29658	1750	200	2.6

Table 3 100-Year Flood Data - Present Conditions
Kashwitna River, Wasilla, Cottonwood and Lucile Creeks

Valley Section	Photo Sheet (No.)	Profile Sheet (No.)	Profile Station (feet)	Flood Widths		Average Velocity (feet/sec.)
				Distance to Left (ft.)	Distance to Right (ft.)	
<u>Cottonwood Creek</u>						
C-A	3	17	800	25	25	3.1
C-B	3	17	1020	25	25	5.8
C-C	3	17	1640	50	60	3.7
C-D	3	17	2220	50	50	3.7
C-E	3	17	2750	35	35	3.1
C-F	3	17	3620	65	65	2.6
C-G	3	17	3860	25	25	5.9
C-H	3	17	4900	40	60	4.0
C-I	3	17	5890	25	25	2.8
C-JRD	3	17	5990	40	90	8.0
C-K	3	17	6090	40	90	1.1
C-L	3	17	6040	35	35	4.6
C-M	3	18	6990	50	290	3.1
C-MRD	3	18	7040	50	330	8.0
C-N	3	18	7160	120	260	0.5
C-O	3	18	7580	130	120	1.2
C-P	3	18	8520	70	70	2.2
C-Q	3	18	9050	25	25	4.8
C-R	3	18	9640	25	25	4.7
C-SRD	3	18	9680	60	40	11.5
C-T	3	18	9800	60	40	1.5
C-U	3	18	11060	40	140	2.4
C-V	4	18	11920	160	140	1.4
C-W	4	18	12260	30	30	6.6
C-X	4	18	12710	50	40	4.7
C-Y	4	19	13580	20	20	9.9
C-Z	4	19	14400	30	30	6.4
C-AARD	4	19	14500	50	80	5.8
C-AB	4	19	14520	50	80	1.5
C-AC	4	19	15760	90	50	1.9

Table 3 100-Year Flood Data - Present Conditions
Kashwitna River, Wasilla, Cottonwood and Lucile Creeks

Valley Section	Photo Sheet (No.)	Profile Sheet (No.)	Profile Station (feet)	Flood Widths		Average Velocity (feet/sec.)
				Distance to Left (ft.)	Distance to Right (ft.)	
C-AD	4	19	17050	120	50	1.9
C-AE	4	20	19350	60	100	2.6
C-AF	4	20	20580	70	30	3.5
C-AG	4	20	22030	60	40	2.7
C-AH	4	20	23150	50	40	2.3
C-AI	5	20	23790	150	70	1.6
CAJRD	5	20	23840	250	50	3.8
C-AK	5	20	23890	40	60	1.6
C-AL	5	20	24890	130	30	1.6
C-AM	5	21	26590	70	50	2.6
C-AN	5	21	29230	30	50	2.6
C-AO	5	21	31550	80	60	2.0
C-AP	5	22	32330	30	40	2.5
C-AQRD	5	22	32450	40	20	3.8
C-AR	5	22	32490	40	20	1.5
C-AS	5	22	33830	40	30	2.3
C-AT	6	22	35410	60	40	2.2
C-AU	6	22	37390	40	60	3.1
C-UA	6	23	38890	30	20	2.5
C-AVRD	6	23	38990	150	530	15.5
C-AW	6	23	39040	300	600	0.1
C-AX	6	23	40120	430	70	0.2
C-AY	6	23	41120	620	30	0.6
C-AZRR	6	23	41220	20	40	2.0
C-BA	6	23	41300	30	80	2.0
C-BB	6	23	41500	30	60	1.3
C-BCRD	6	23	41600	25	25	3.1
C-BD	6	23	41700	30	30	0.4
C-BE	6	23	42400	140	140	1.5
C-BF	6	23	42820	80	120	0.8
C-BGHY	6	23	42920	30	250	17.5

Table 3 100-Year Flood Data - Present Conditions
Kashwitna River, Wasilla, Cottonwood and Lucile Creeks

Valley Section	Photo Sheet (No.)	Profile Sheet (No.)	Profile Station (feet)	Flood Widths		Average Velocity (feet/sec.)
				Distance to Left (ft.)	Distance to Right (ft.)	
C-BH	6	23	43020	110	1030	0.1
C-BI	6	23	43650	110	1050	0.1
C-BJ	6	24	44890	560	270	0.2
C-BK	7	24	45470	510	290	0.1
C-BL	7	24	46150	800	420	0.1
C-BMRD	7	24	46210	150	370	0.1
C-BN	7	24	46270	290	290	0.1
C-BP	7	25	55730	200	270	0.1
C-BQ	7	25	56670	150	150	1.0
C-BRRD	7	25	56750	110	130	11.2
C-BS	8	25	56820	180	180	0.4
C-BT	8	26	59560	110	200	0.2
C-BU	8	26	67890	50	160	0.6
C-BV	8	26	69460	20	100	1.6
C-BW	8	27	71440	60	50	3.7
C-BXRD	8	27	71540	50	50	12.8
C-BY	8	27	71640	50	50	1.0
C-BZ	8	27	74680	50	60	2.0
<u>Wasilla Creek</u>						
WA-A	9	6	00	60	150	2.6
WA-B	9	6	880	40	90	2.9
WA-C	9	6	1740	30	60	4.0
WA-D	9	6	2340	50	100	3.2
WA-E	9	6	3190	70	30	4.8
WA-F	9	6	4200	20	20	5.7
WA-G	9	6	5850	70	30	4.0
WA-H	9	7	7480	50	260	2.5
WA-I	9	7	9270	40	250	2.4
WA-J	9	7	10760	80	10	3.9
WA-KRR	9	7	10860	30	30	4.9

Table 3 100-Year Flood Data - Present Conditions

Kashwitna River, Wasilla, Cottonwood and Lucile Creeks

Valley Section	Photo Sheet (No.)	Profile Sheet (No.)	Profile Station (feet)	Flood Widths		Average Velocity (feet/sec.)
				Distance to Left (ft.)	Distance to Right (ft.)	
WA-L	9	7	10950	450	100	0.8
WA-M	9	7	11130	510	30	0.9
WA-NHY	9	7	11240	20	20	6.2
WA-O	9	7	11320	30	20	5.9
WA-P	10	8	12770	50	50	2.6
WA-Q	10	8	14360	90	130	3.3
WA-RRD	10	8	14370	160	120	6.0
WA-S	10	8	14530	170	120	1.6
WA-T	10	8	15470	180	110	2.5
WA-U	10	8	16040	310	100	2.2
WA-V	10	9	18550	30	80	2.9
WA-WRD	10	9	18660	30	270	6.0
WA-X	10	9	18750	300	100	2.1
WA-Y	10	9	20070	100	230	2.2
WA-Z	10	9	21810	120	60	3.2
WA-AC	11	9	23470	70	180	2.3
WA-AD	11	10	26678	30	180	2.2
WA-AE	11	10	28022	20	220	2.6
WA-AF	11	10	31258	380	115	1.7
WA-AG	11	11	33954	10	50	5.1
WA-AH	12	11	35526	650	40	1.7
WA-AI	12	11	36814	310	60	1.3
WAAJRD	12	11	36914	1030	30	6.0
WA-AK	12	11	37014	1030	30	0.8
WA-CA	12	12	38118	460	50	1.7
WACBRD	12	12	38218	260	100	7.9
WA-CC	12	12	38388	160	100	1.3
WA-AL	12	12	39426	50	160	2.0
WA-ALI	12	12	40138	160	200	1.8
WA-AM	12	12	41074	60	30	1.7
WA-AN	12	12	42250	100	40	3.6

Table 3 100-Year Flood Data - Present Conditions
Kashwitna River, Wasilla, Cottonwood and Lucile Creeks

Valley Section	Photo Sheet (No.)	Profile Sheet (No.)	Profile Station (feet)	Flood Widths		Average Velocity (feet/sec.)
				Distance to Left (ft.)	Distance to Right (ft.)	
WA-AO	12	13	44148	40	30	1.6
WAAPRD	12	13	44300	100	50	5.5
WA-AQ	12	13	44430	100	130	1.1
WA-AR	12	13	45134	130	60	1.2
WA-AS	12	13	46336	320	10	3.2
WA-AT	12	13	48476	80	110	3.5
WA-AU	13	14	50366	80	20	3.8
WA-AV	13	14	52018	30	230	2.2
WA-AW	13	14	54816	120	40	2.9
WA-AX	13	14	55902	20	490	1.6
WA-AY	13	15	58454	40	350	1.5
WA-AZ	13	15	60610	580	120	1.2
WA-BA	13	15	62520	20	170	2.9
WA-BB	13	16	63304	80	90	2.6
WA-BC	13	16	63550	50	80	2.9
WABDHY	13	16	63654	230	700	8.4
WA-BE	13	16	63750	230	730	0.2
WA-BF	13	16	65000	100	110	1.5
<u>Lucile Creek</u>						
L-A	14	28	1320	700	950	0.1
L-B	14	28	1820	1590	210	0.2
L-C	14	28	2420	2040	1020	0.1
L-DRD	14	28	2520	2040	1000	9.9
L-E	14	28	2620	360	190	0.7
L-F	14	28	3970	260	50	1.8
L-G	14	28	5420	130	20	2.5
L-H	14	29	7530	60	110	2.0
L-I	14	29	9930	110	110	2.1

Table 3 100-Year Flood Data - Present Conditions
Kashwitna River, Wasilla, Cottonwood and Lucile Creeks

Valley Section	Photo Sheet (No.)	Profile Sheet (No.)	Profile Station (feet)	Flood Widths		Average Velocity (feet/sec.)
				Distance to Left (ft.)	Distance to Right (ft.)	
L-J	14	30	13340	80	130	1.8
L-K	14	30	15590	100	130	1.1
L-L	14	30	17570	190	830	0.5
L-M	14	31	19550	40	400	1.0
L-N	14	31	22320	200	550	0.7
L-O	14	32	24670	170	520	0.6
L-P	14	32	27180	350	700	0.6
L-Q	14	33	30550	920	130	0.6
L-R	14	33	32580	1810	90	0.4
L-S	14	33	35780	40	150	1.4
L-T	14	34	37770	55	155	1.3
L-U	14	34	40290	280	30	1.0
L-V	15	34	42280	215	360	1.0
L-W	15	35	44270	40	230	1.1
L-X	15	35	46260	10	510	0.7
L-Y	15	35	48250	80	110	1.4
L-Z	15	36	50240	210	100	0.8
L-AA	15	36	52500	420	150	0.8
L-AB	15	36	54490	210	110	0.5
L-AC	15	36	56480	490	130	0.3
L-AD	16	37	58240	60	80	2.1
L-AE	16	37	59560	40	20	2.9
L-AF	16	37	60590	40	240	0.7
L-AG	16	37	61340	10	250	0.5
L-AH	16	37	61640	30	70	2.2

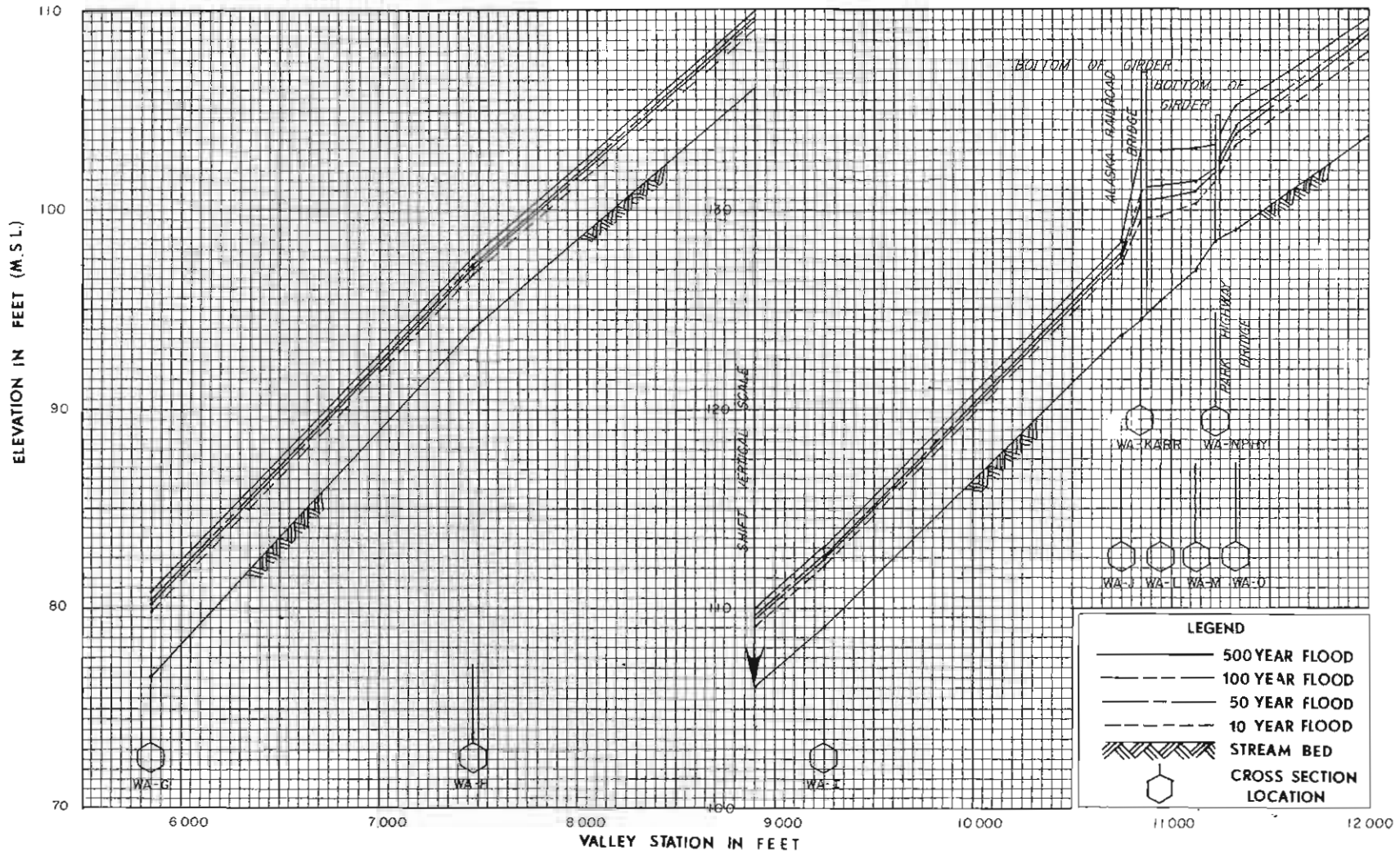

FLOOD PROFILES

MASILLA CREEK

SOIL CONSERVATION SERVICE
 U.S. DEPARTMENT OF AGRICULTURE
 Matanuska-Susitna Borough, Alaska



FLOOD PROFILES

WASILLA CREEK

SOIL CONSERVATION SERVICE
 U.S. DEPARTMENT OF AGRICULTURE
 Matanuska-Susitna Borough, Alaska



FLOOD PROFILES

SOIL CONSERVATION SERVICE
 U.S. DEPARTMENT OF AGRICULTURE
 Matanuska-Susitna Borough, Alaska

WASTILLA CREEK



FLOOD PROFILES

WASILLA CREEK

SOIL CONSERVATION SERVICE
 U.S. DEPARTMENT OF AGRICULTURE
 Matanuska - Susitna Borough, Alaska



FLOOD PROFILES

WASILLA CREEK

SOIL CONSERVATION SERVICE
 U.S. DEPARTMENT OF AGRICULTURE
 Matanuska-Susitna Borough, Alaska

SHEET 130P37

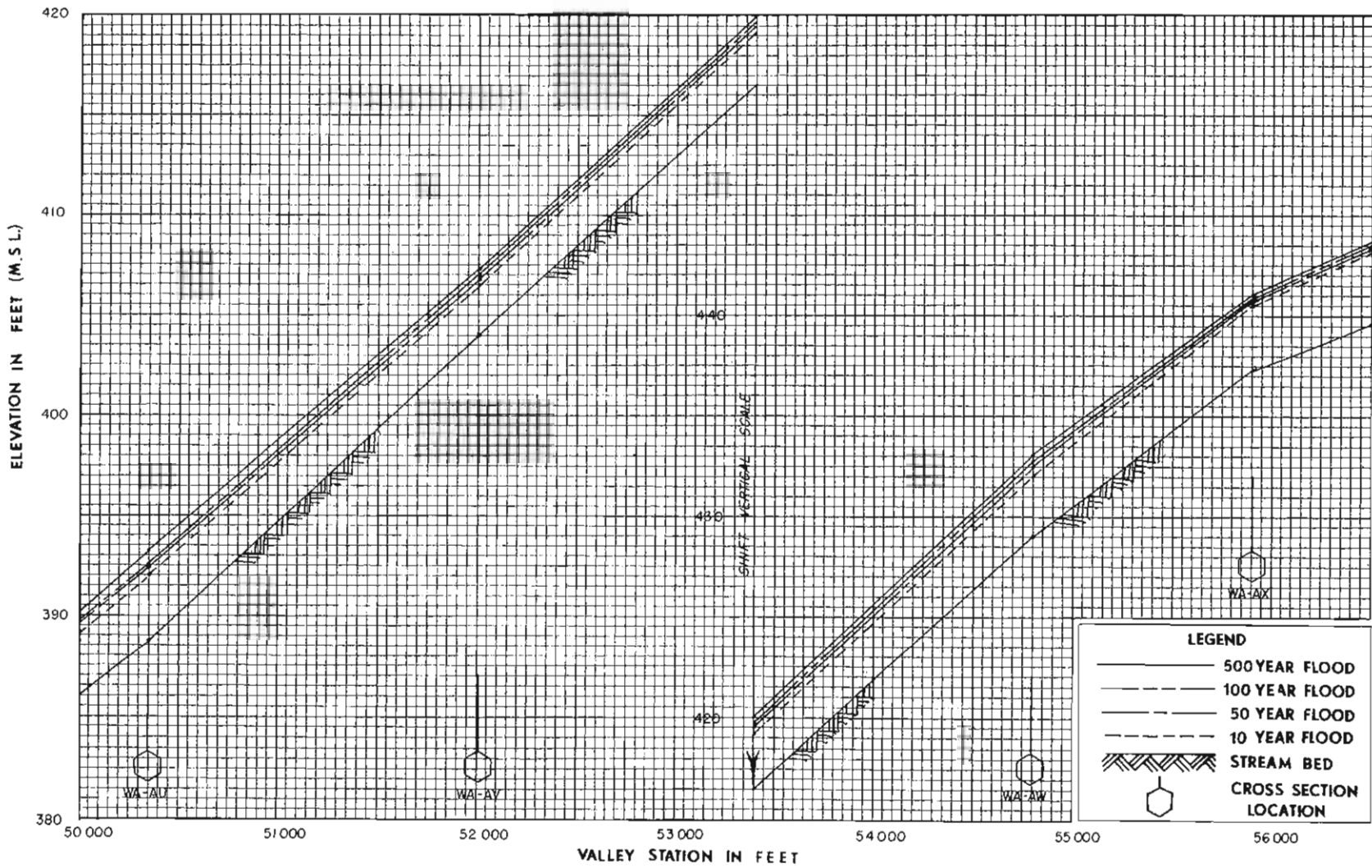

FLOOD PROFILES

WASILLA CREEK

SOIL CONSERVATION SERVICE
 U.S. DEPARTMENT OF AGRICULTURE
 Matanuska-Susitna Borough, Alaska

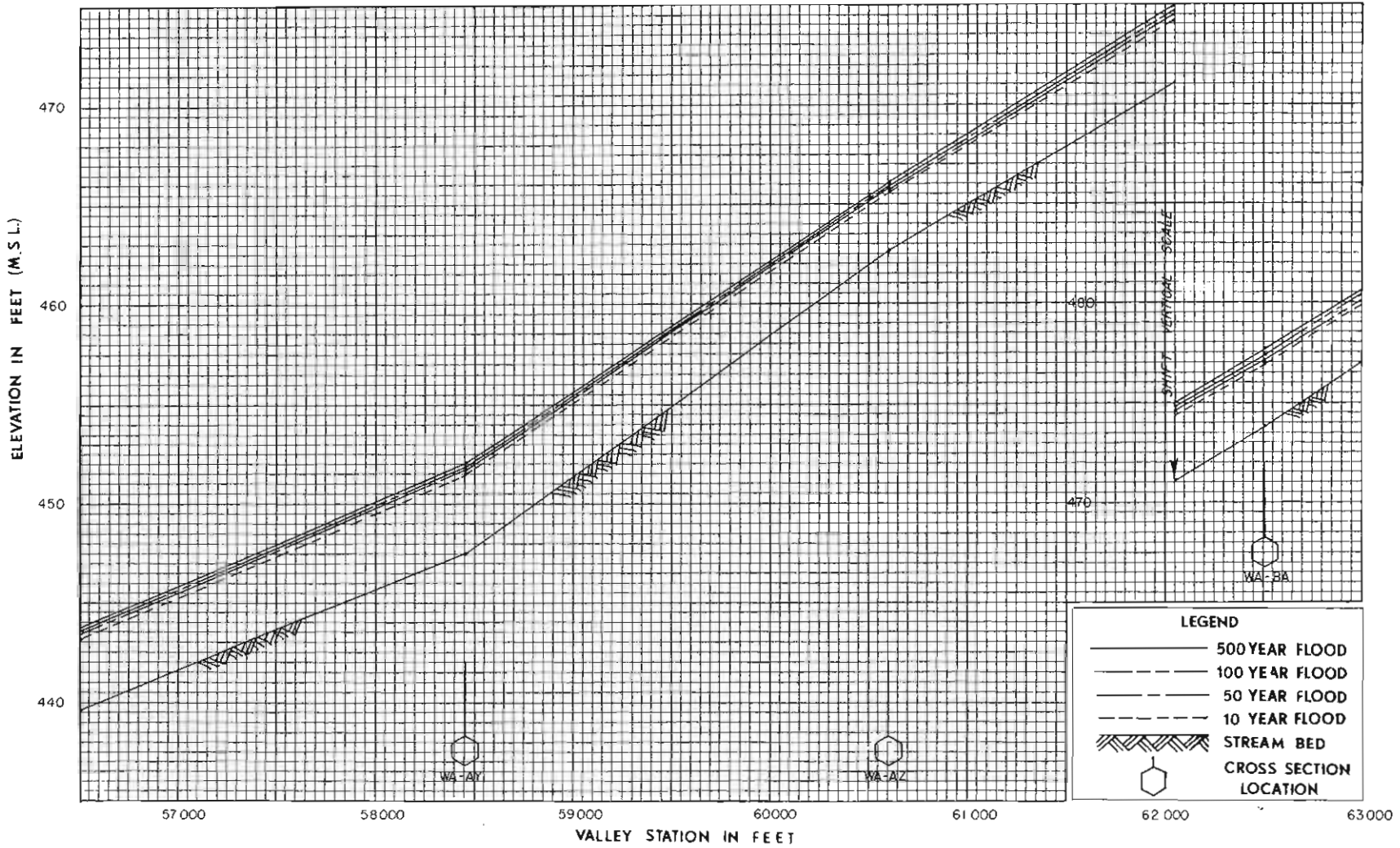

FLOOD PROFILES

WASILLA CREEK

SOIL CONSERVATION SERVICE
 U.S. DEPARTMENT OF AGRICULTURE
 Matanuska - Susitna Borough, Alaska

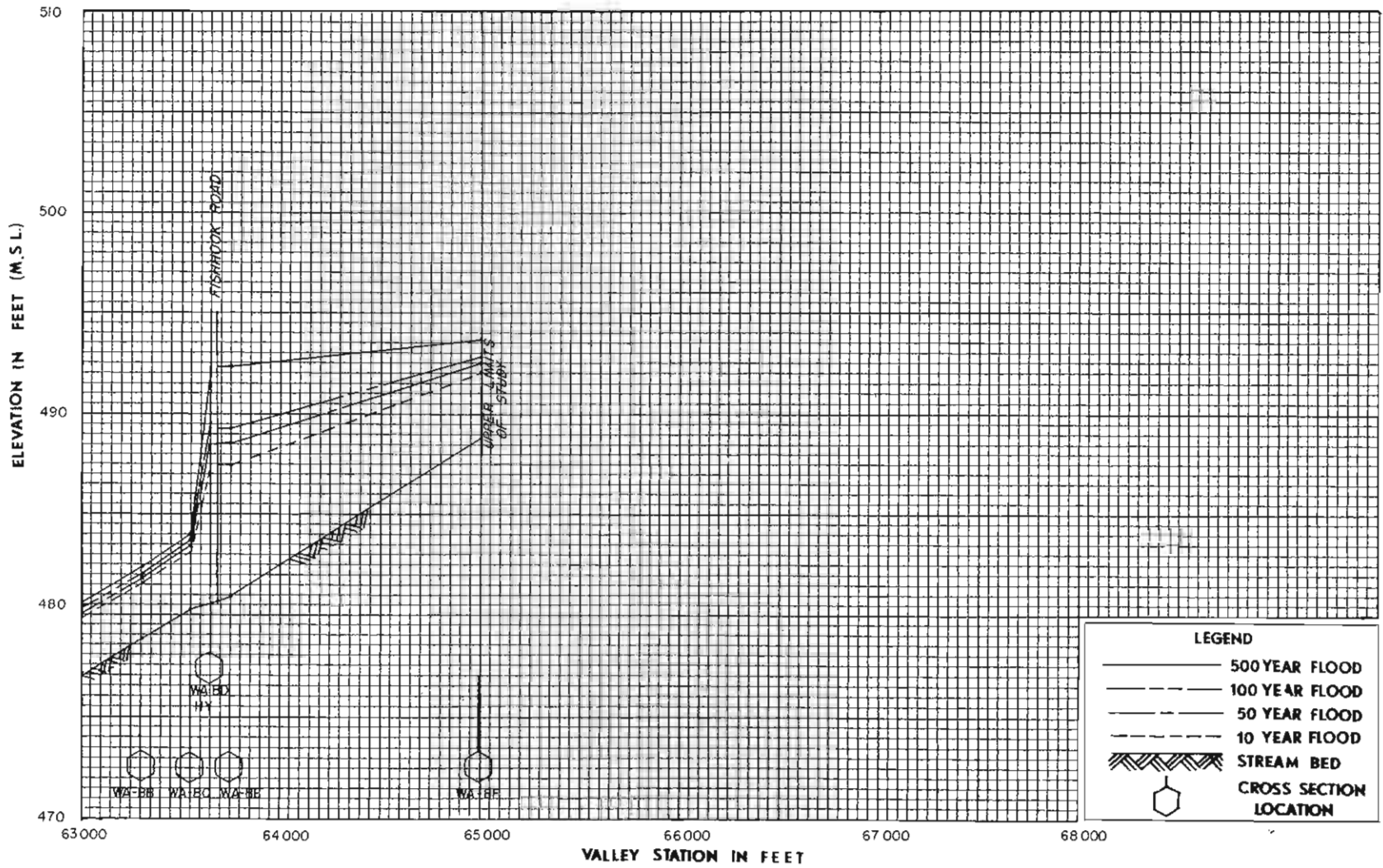

LEGEND

- 500 YEAR FLOOD
- - - - 100 YEAR FLOOD
- 50 YEAR FLOOD
- - - - 10 YEAR FLOOD
- ////// STREAM BED
- ⬠ CROSS SECTION LOCATION

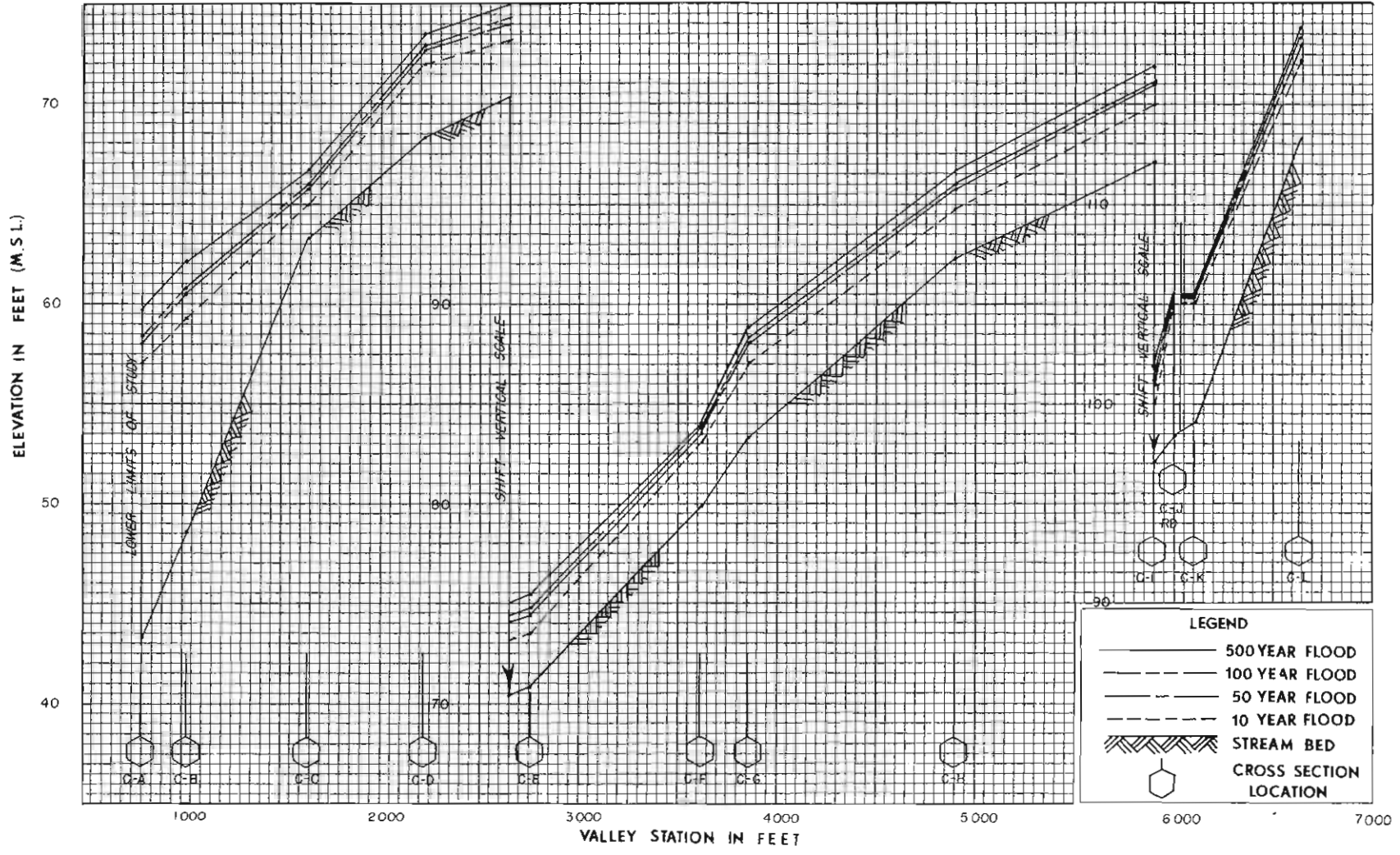

FLOOD PROFILES

COTTONWOOD CREEK

SOIL CONSERVATION SERVICE
 U.S. DEPARTMENT OF AGRICULTURE
 Matanuska-Susitna Borough, Alaska

SHEET 17 OF 37

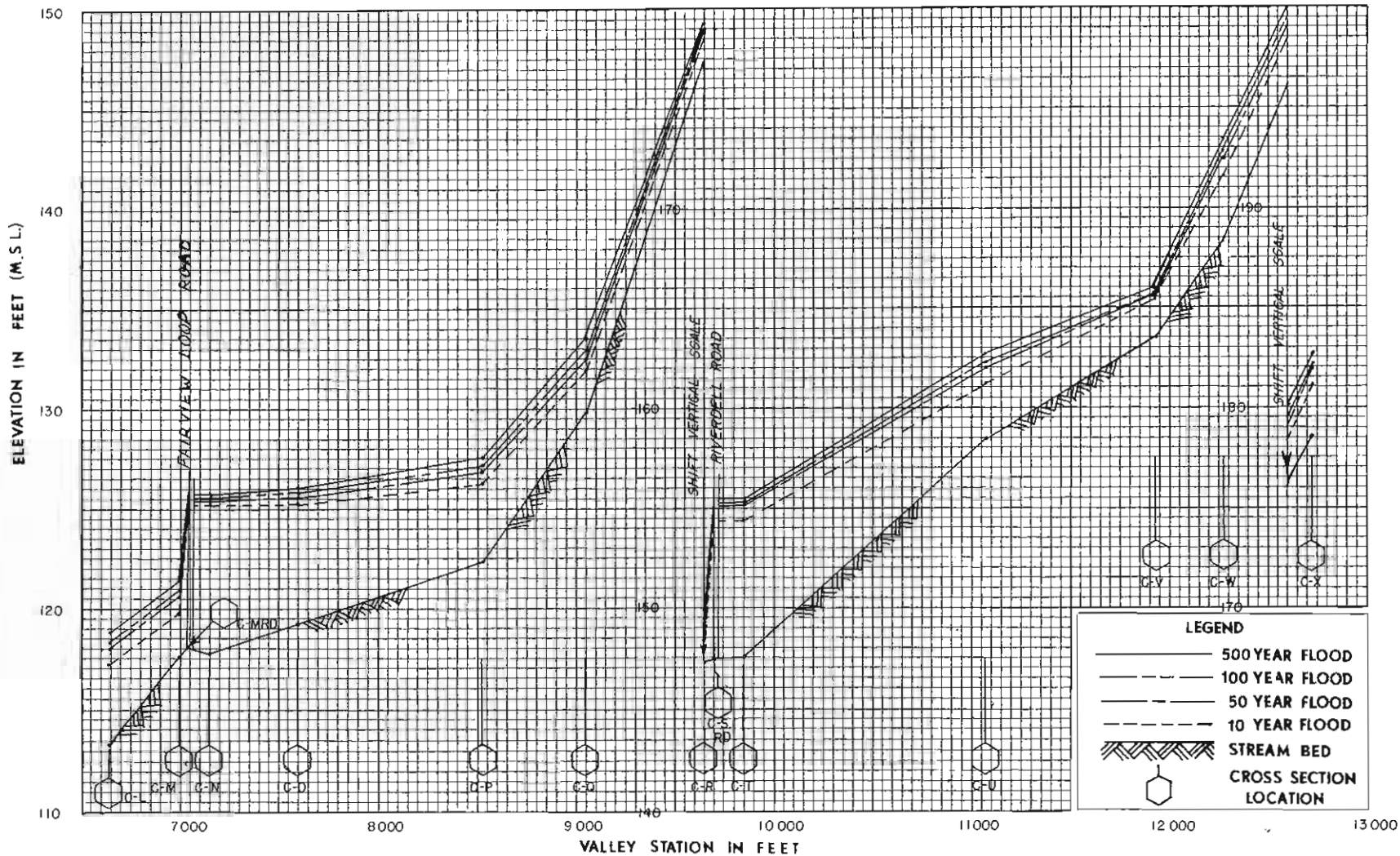

FLOOD PROFILES

COTTONWOOD CREEK

SOIL CONSERVATION SERVICE
 U.S. DEPARTMENT OF AGRICULTURE
 Matanuska-Susitna Borough, Alaska

SHEET 180F37

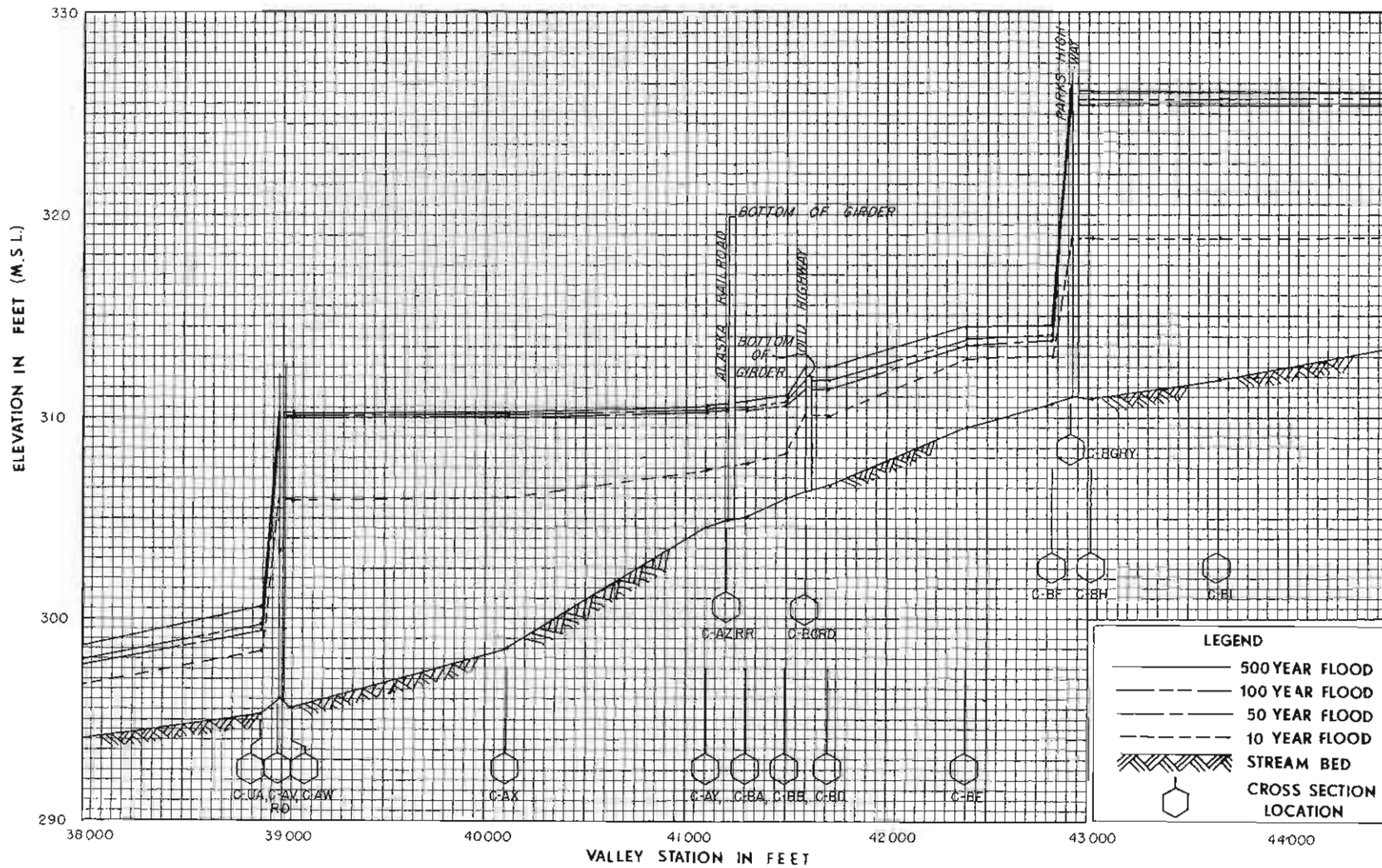

FLOOD PROFILES

COTTONWOOD CREEK

SOIL CONSERVATION SERVICE
 U.S. DEPARTMENT OF AGRICULTURE
 Matanuska-Susitna Borough, Alaska

SHEET 23 OF 37



FLOOD PROFILES

SOIL CONSERVATION SERVICE
 U.S. DEPARTMENT OF AGRICULTURE
 Matanuska-Susitna Borough, Alaska

COTTONWOOD CREEK

SHEET 25 OF 37

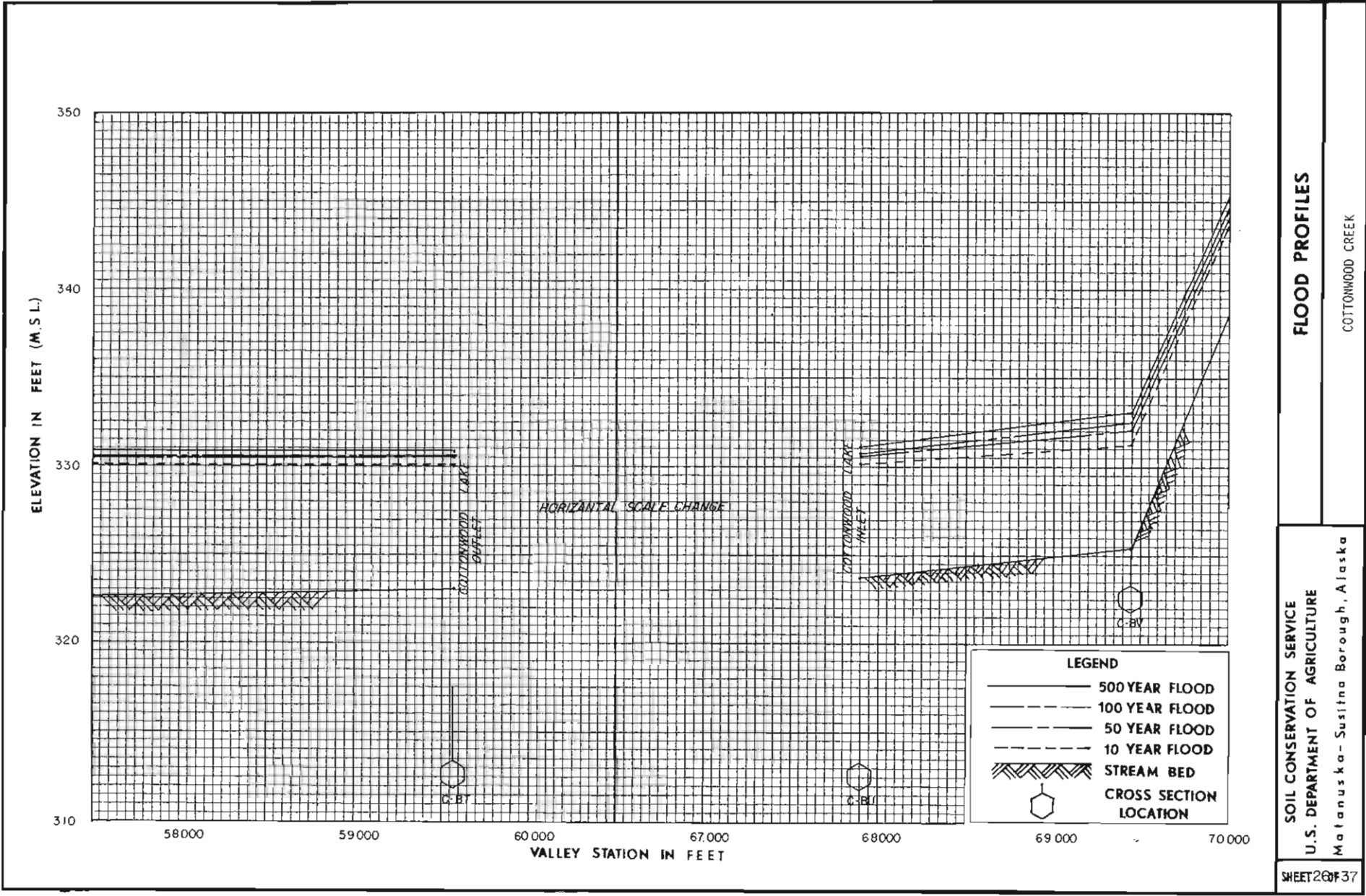

FLOOD PROFILES

COTTONWOOD CREEK

SOIL CONSERVATION SERVICE
 U.S. DEPARTMENT OF AGRICULTURE
 Matanuska-Susitna Borough, Alaska

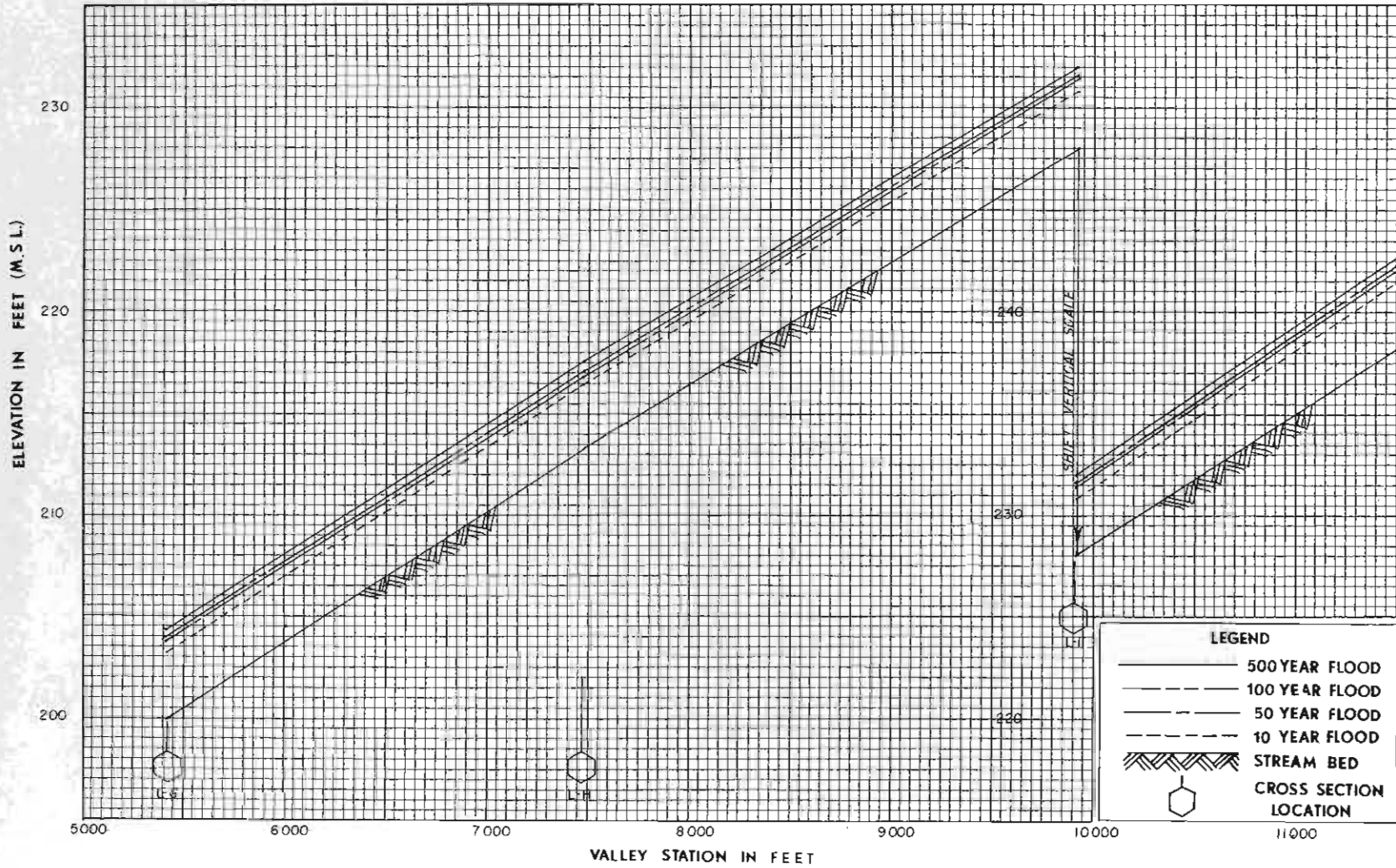

FLOOD PROFILES

LUCILE CREEK

SOIL CONSERVATION SERVICE
 U.S. DEPARTMENT OF AGRICULTURE
 Matanuska-Susitna Borough, Alaska

SHEET 29 OF 37

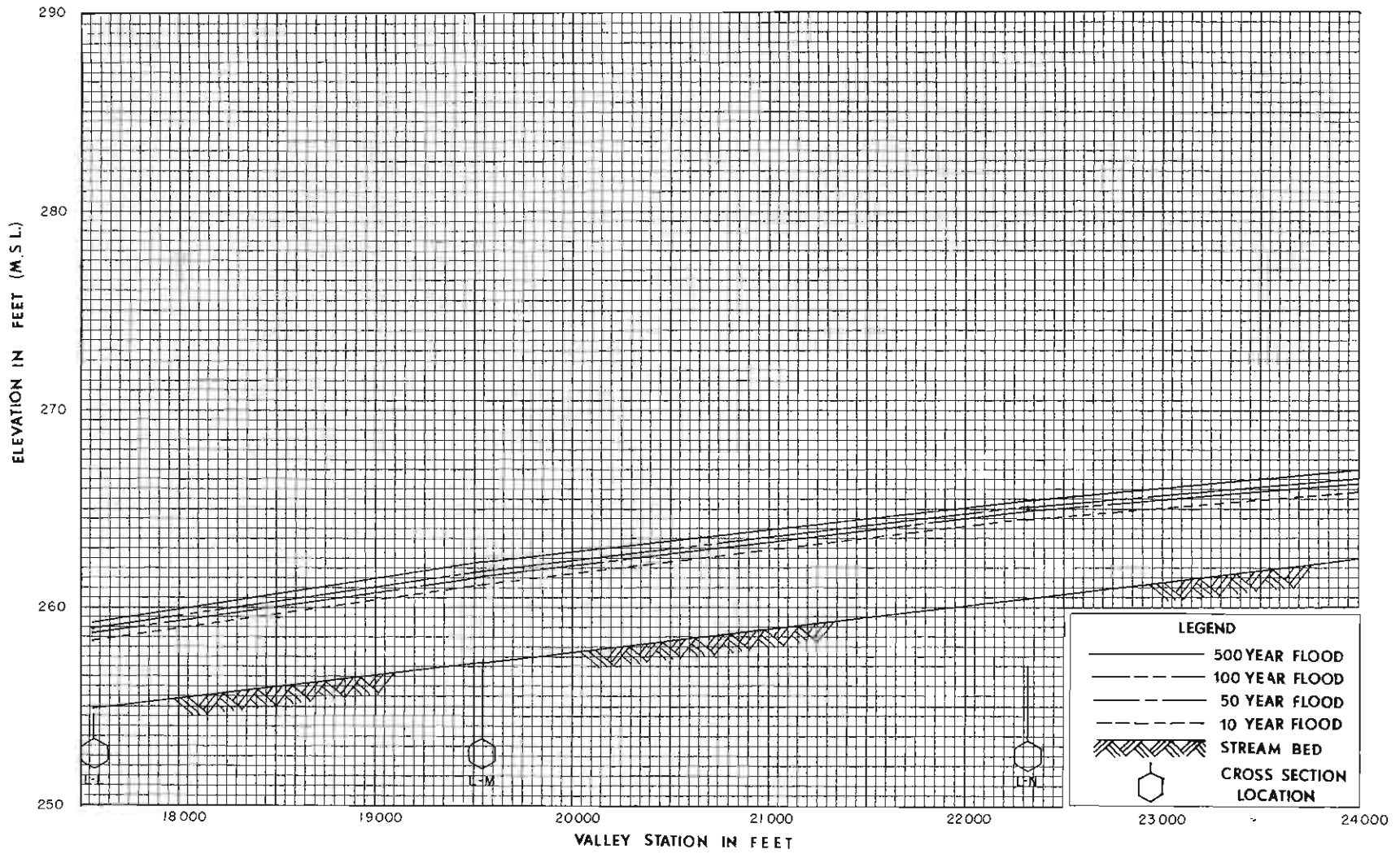

FLOOD PROFILES

LUCILLE CREEK

SOIL CONSERVATION SERVICE
 U.S. DEPARTMENT OF AGRICULTURE
 Matanuska-Susitna Borough, Alaska

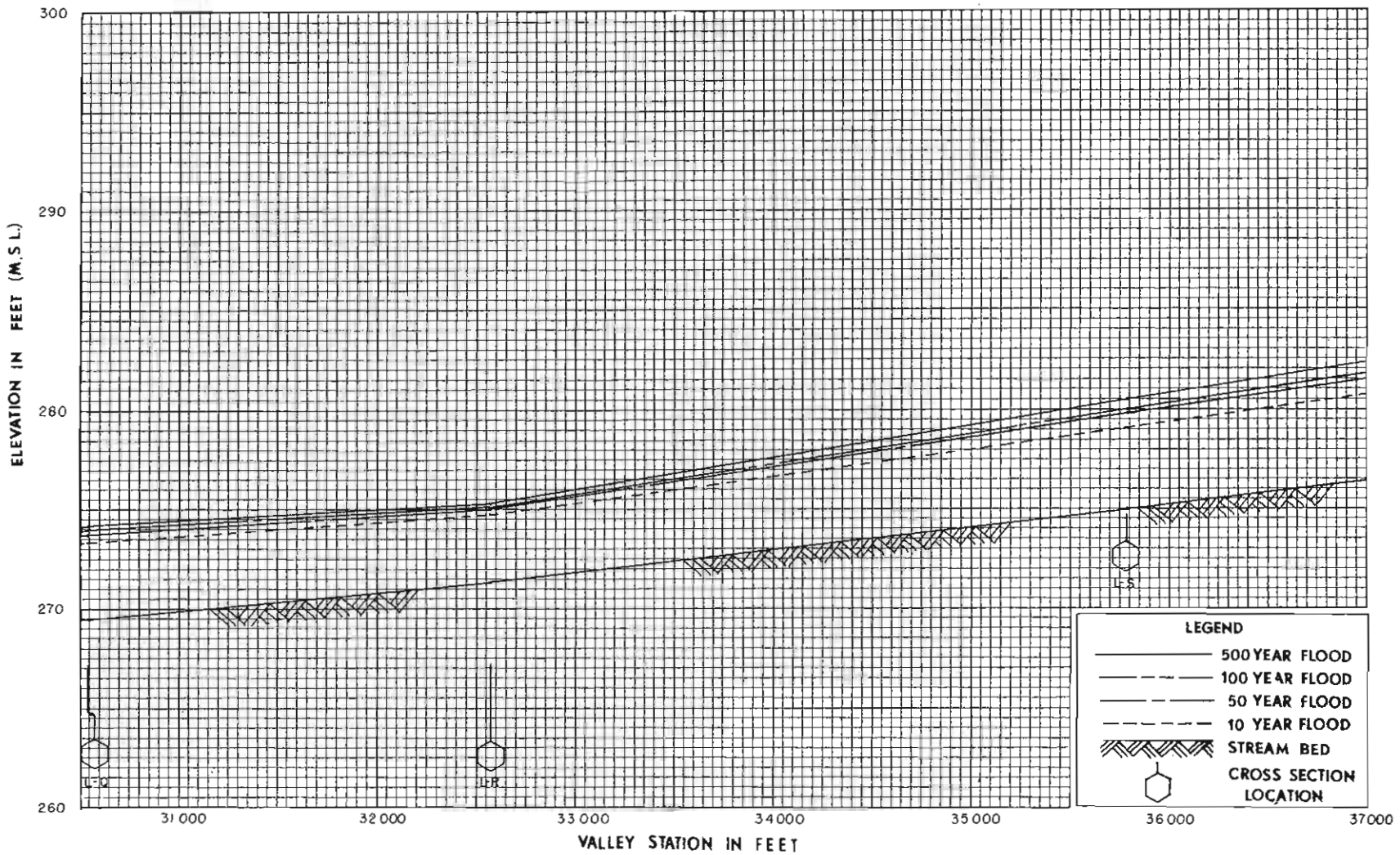

FLOOD PROFILES

LUCILE CREEK

SOIL CONSERVATION SERVICE
U.S. DEPARTMENT OF AGRICULTURE

Matanuska-Susitna Borough, Alaska

SHEET 330F37



FLOOD PROFILES

LUCILLE CREEK

SOIL CONSERVATION SERVICE
 U.S. DEPARTMENT OF AGRICULTURE
 Matanuska-Susitna Borough, Alaska

SHEET 350P 37

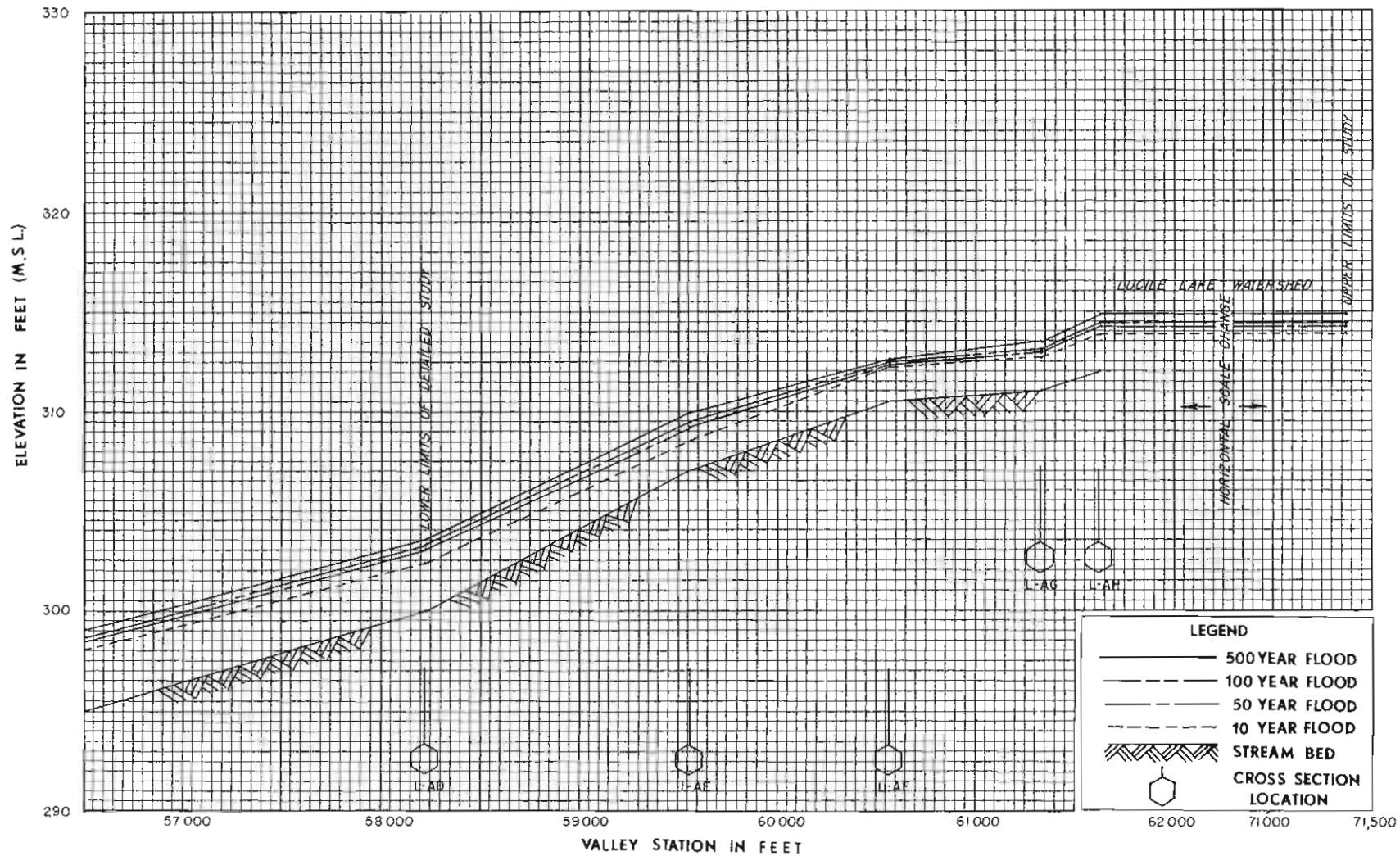

FLOOD PROFILES

LUCILE CREEK

SOIL CONSERVATION SERVICE
 U.S. DEPARTMENT OF AGRICULTURE
 Matanuska-Susitna Borough, Alaska

SHEET 37 OF 37

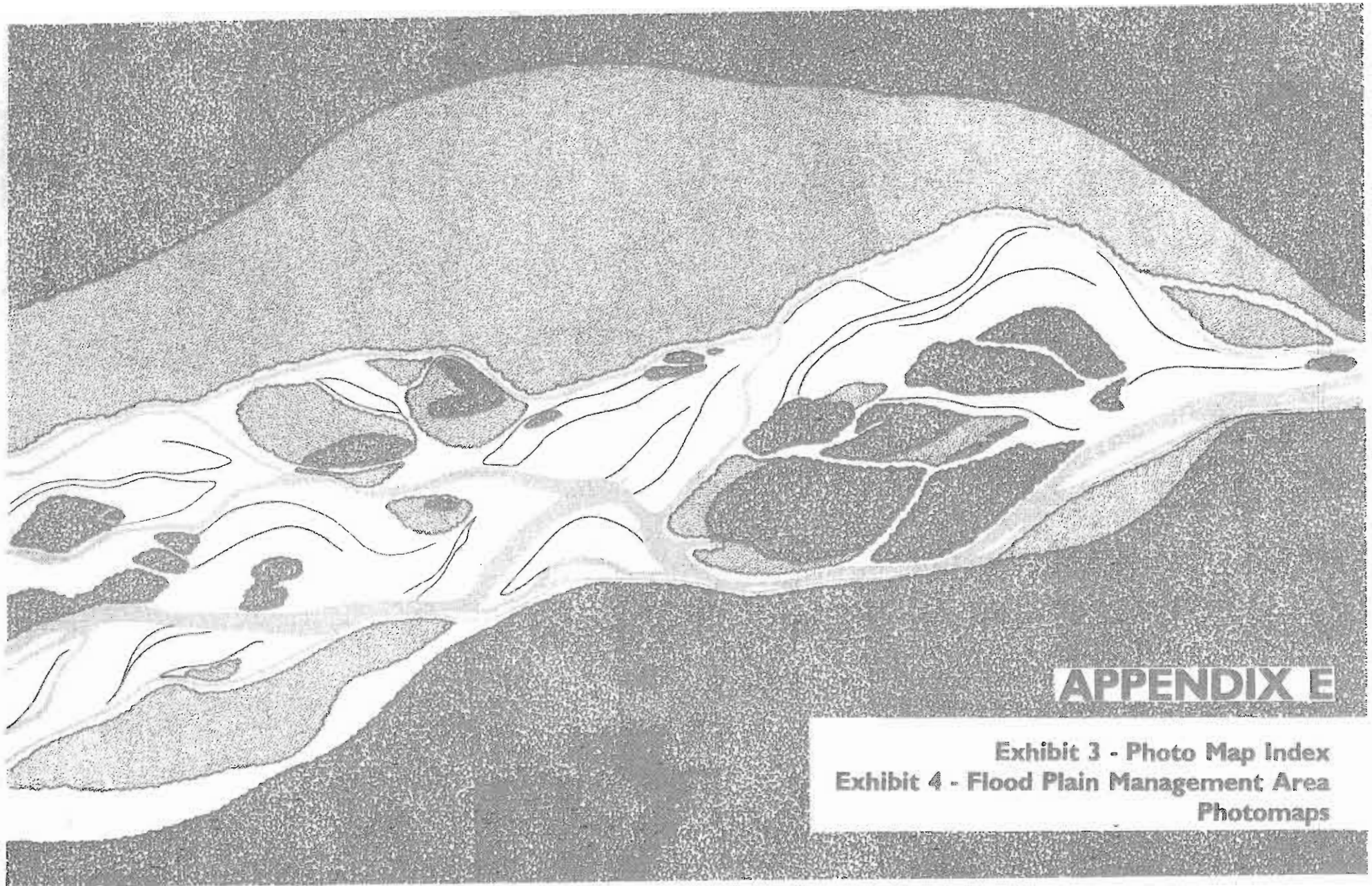

APPENDIX E

Exhibit 3 - Photo Map Index
Exhibit 4 - Flood Plain Management Area
Photomaps

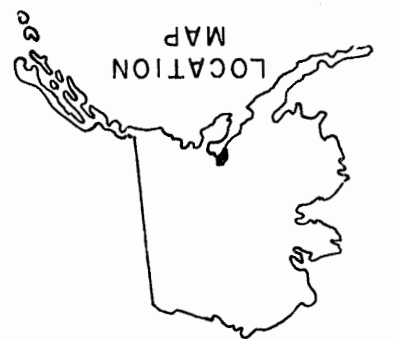
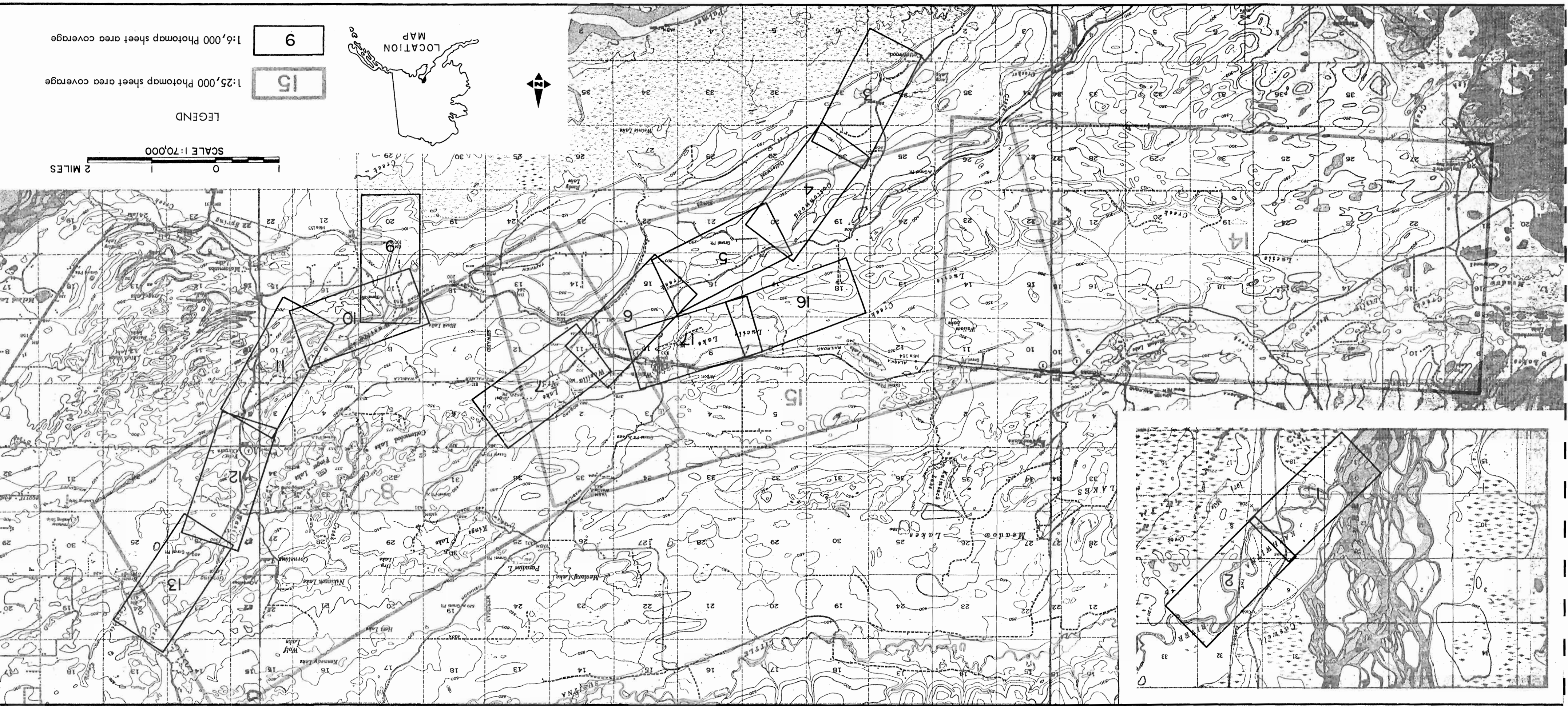
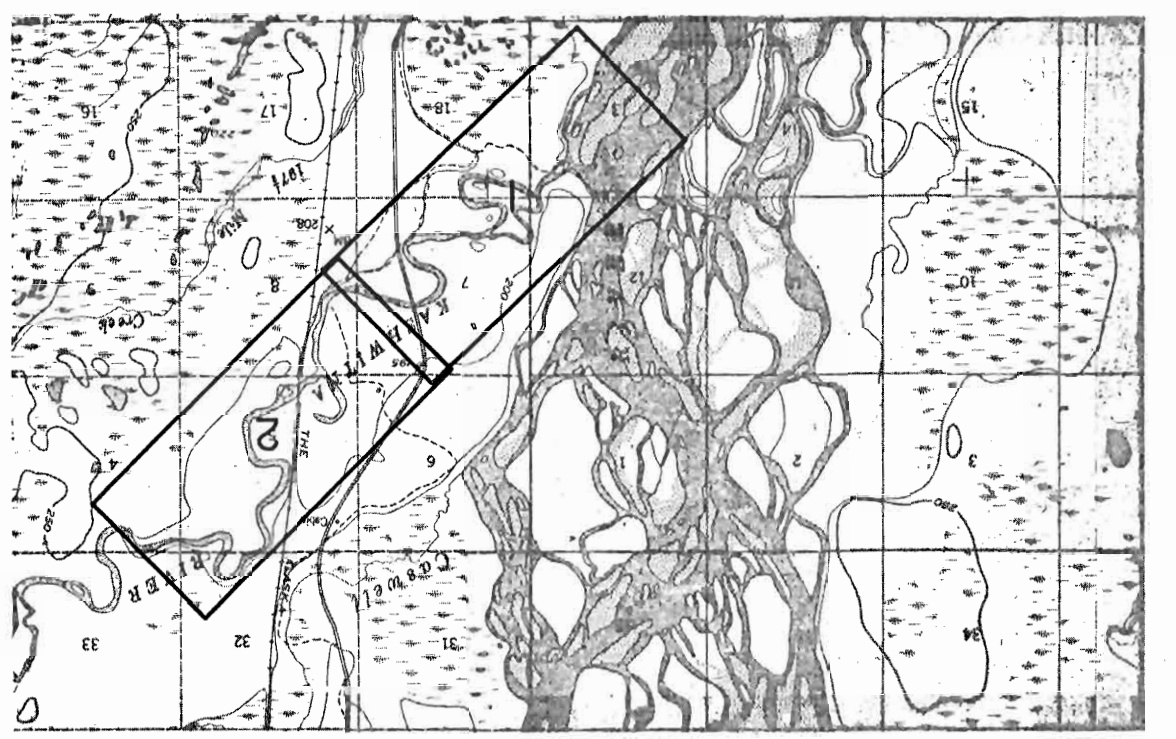

9

15

1:25,000 Photomap sheet area coverage

1:6,000 Photomap sheet area coverage

LEGEND

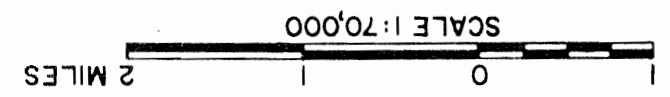

SHEET 1 OF 1

U.S. DEPARTMENT OF AGRICULTURE
SOIL CONSERVATION SERVICE
MATANUSKA VALLEY
ALASKA

PHOTOMAP INDEX

KASHIWINA RIVER, WASILLA, COTTONWOOD AND LUCILLE CREEKS



General 100 Year Flood
 Approximate 100 Year Flood
 Cross Section Location
 Shaded Channel

U.S. DEPARTMENT OF AGRICULTURE
 SOIL CONSERVATION SERVICE
 MATANUSKA VALLEY
 ALASKA

X 100 Elevation Reference Mark
 (Each of flooding may vary from actual location on the ground)
 A.P.T. Photography 10/14/80
 SCALE IN FEET
 0 500 1000 FEET

FLOOD PLAIN MANAGEMENT STUDY
LUCILE CREEK

U.S. DEPARTMENT OF AGRICULTURE
 SOIL CONSERVATION SERVICE
 MATANUSKA VALLEY
 ALASKA

FLOOD PLAIN MANAGEMENT STUDY
 LUCILLE CREEK

LEGEND

Designated Flood Plain
 Flood
 Assessment Zone
 Base Channel
 Down Section
 Up Section
 Location
 Base Channel
 Line of flooding when very high
 Special Section on the ground
 A.T.T. Management Structure

0 500 1000 2000
 FEET
 METERS

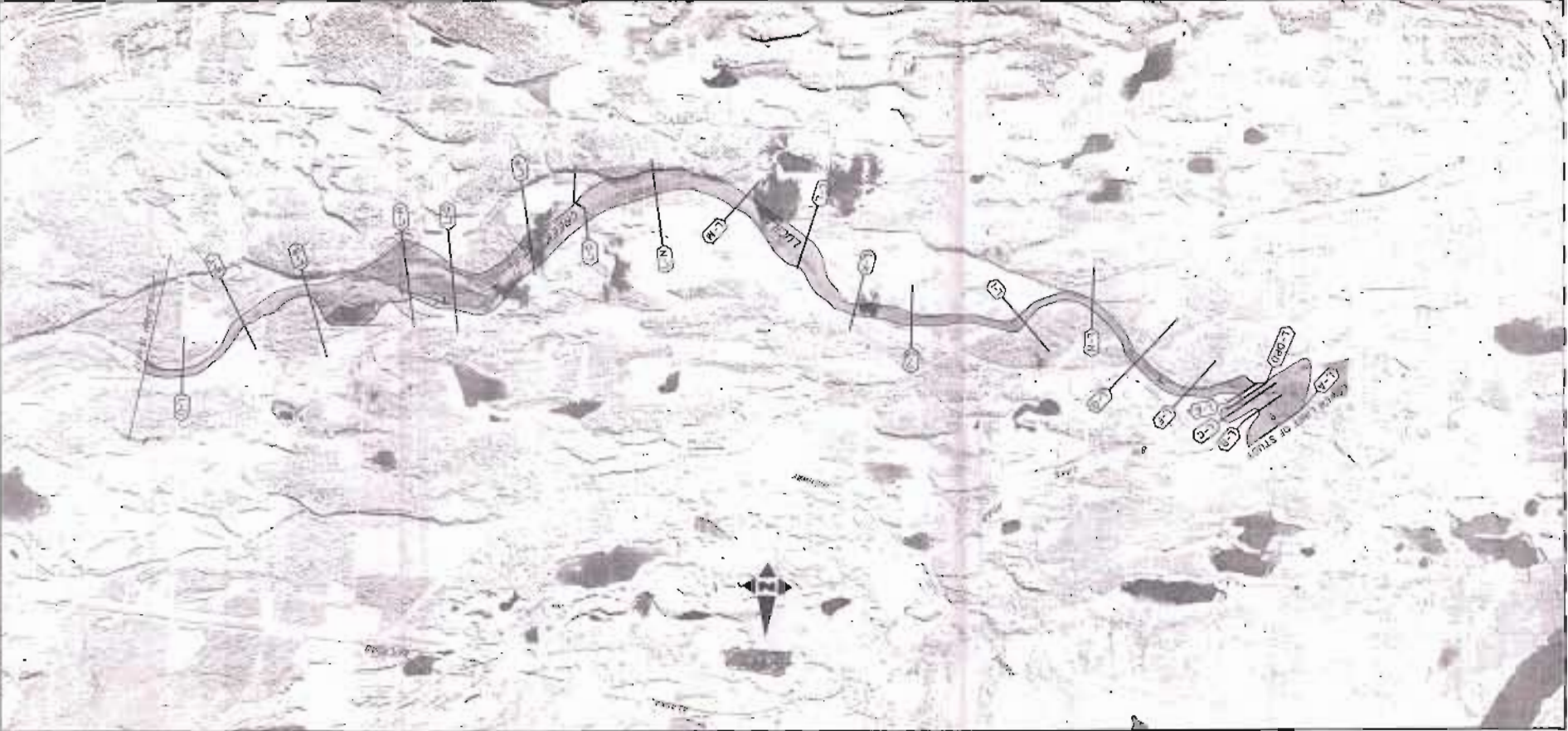

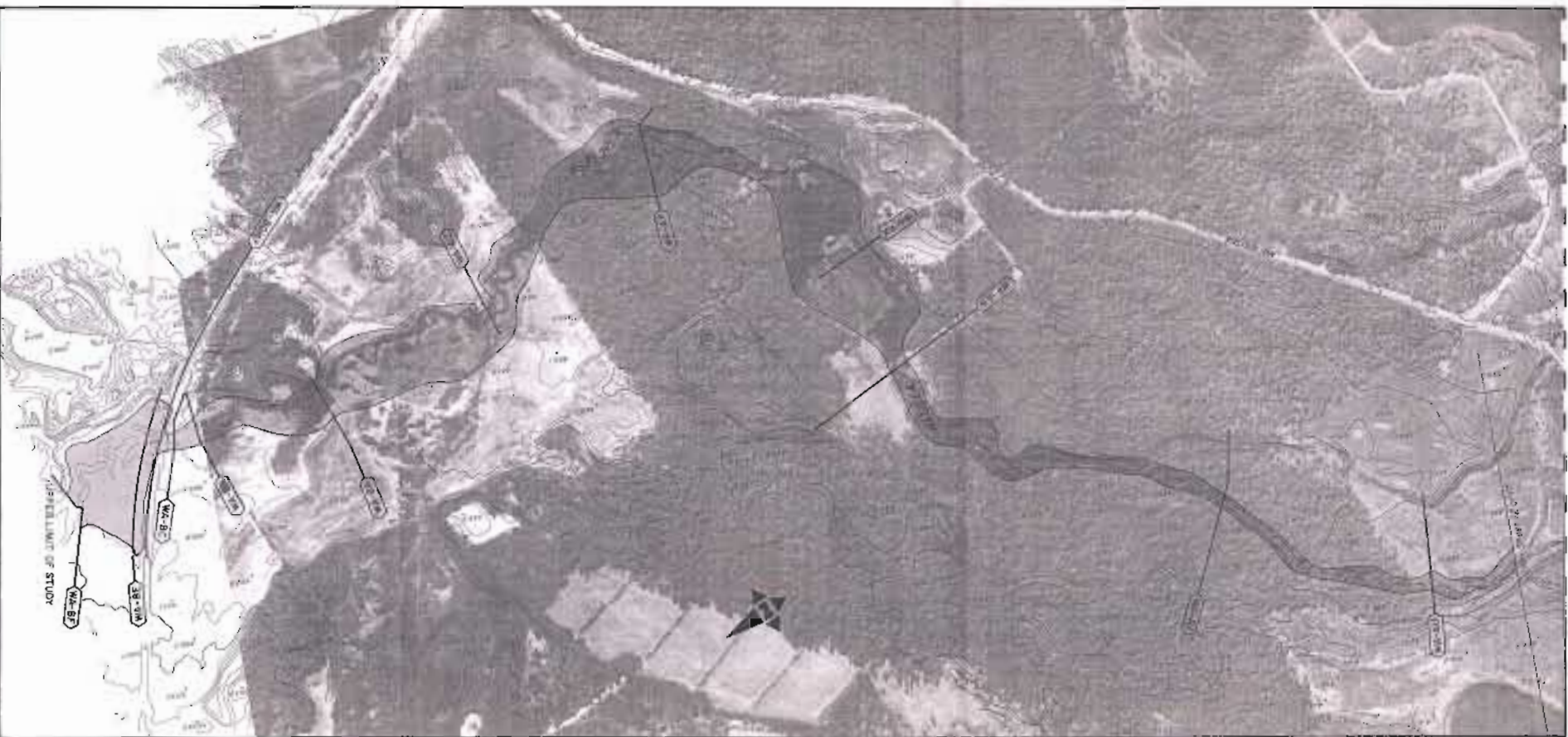

Detailed 100 Year Flood
 Approximate 100 Year Flood
 Cray Stream Location
 Street Channel

K-100 Elevation Reference Marks
 Links of flooding may vary from
 given location on the ground
 APT Photography 10/14/95

500 0 500
 SCALE IN FEET

SHEET 13 OF 17
 U.S. DEPARTMENT OF AGRICULTURE
 SOIL CONSERVATION SERVICE
 MATANUSKA VALLEY
 ALASKA
FLOOD PLAIN MANAGEMENT STUDY
 WASILLA CREEK

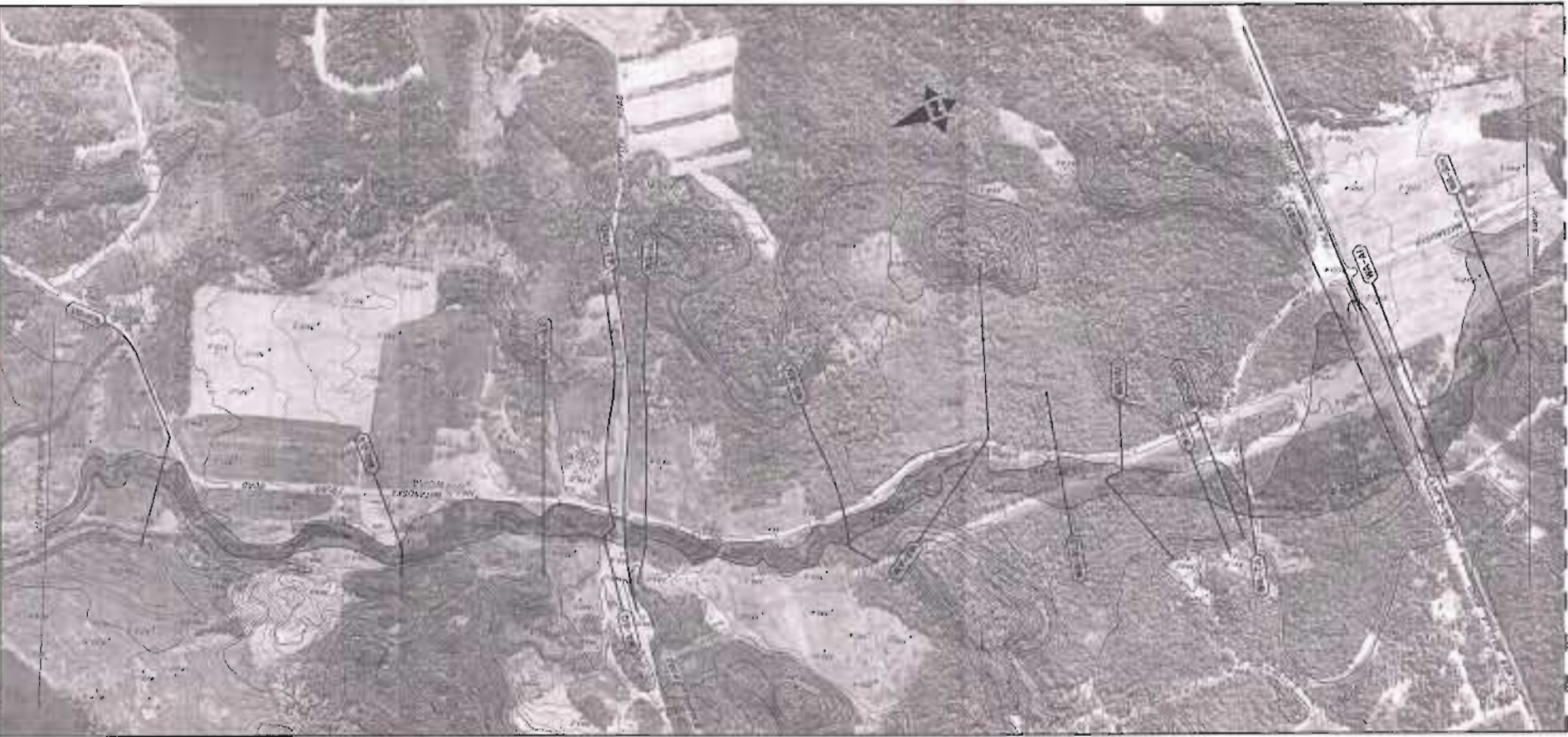

100 Year Flood
 50 Year Flood
 10 Year Flood
 Check Station
 Section
 Stream Channel

X Spot Elevation Station Mark
 Units of flooding are feet from
 actual location on the ground
 4:11 Photogrammetry 10/14/85

SCALE IN FEET
 0 50 100

U.S. DEPARTMENT OF AGRICULTURE
 SOIL CONSERVATION SERVICE
 MATANUSKA VALLEY
 ALASKA

FLOOD PLAIN MANAGEMENT STUDY
 WASILLA CREEK

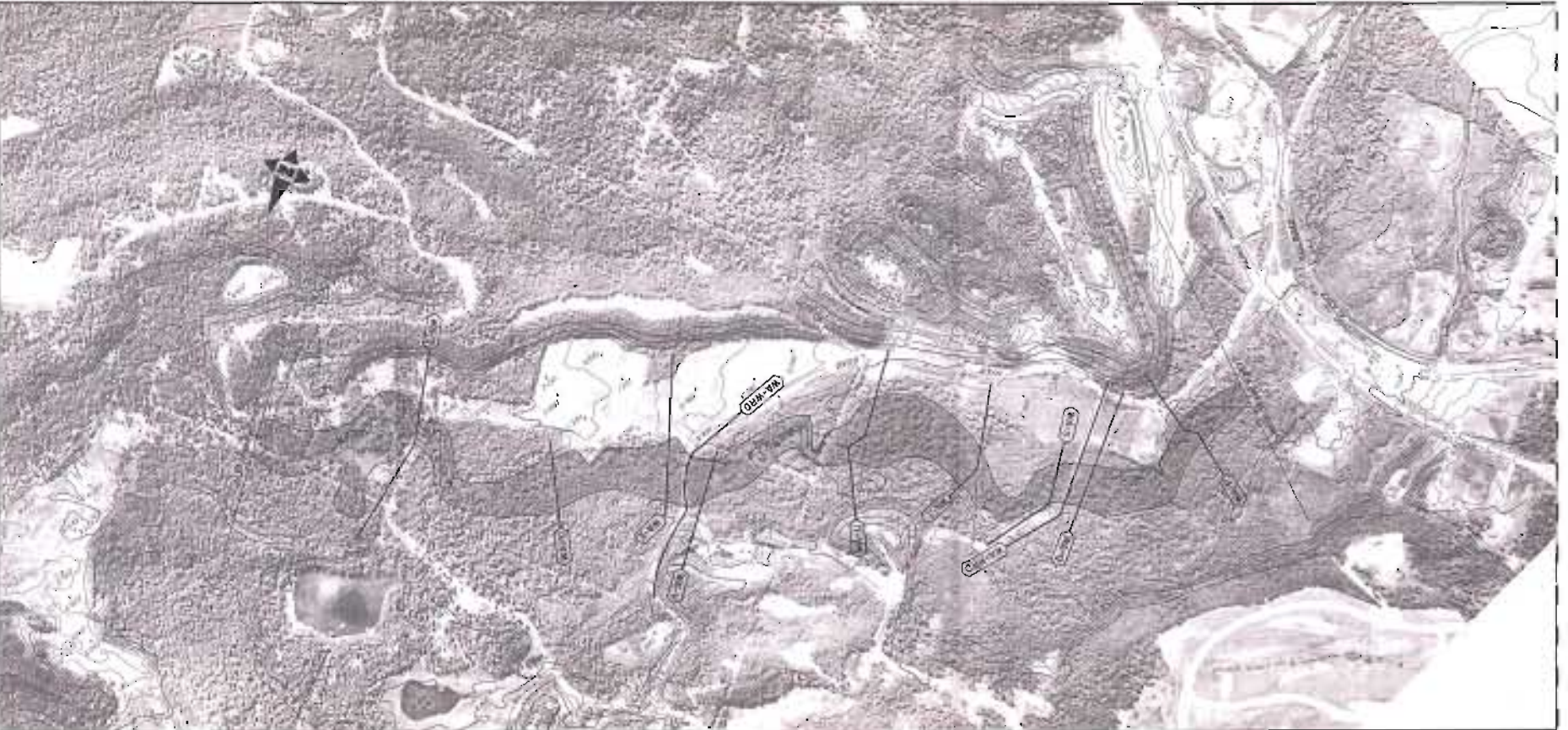

SHEET 10 OF 27

U.S. DEPARTMENT OF AGRICULTURE
SOIL CONSERVATION SERVICE
MATANUSKA VALLEY
ALASKA

FLOOD PLAIN MANAGEMENT STUDY
WASILLA CREEK

Legend:
 Dashed 100 Year Flood
 Apparent 100 Year Flood
 Crest Station
 Structure
 Stream Channel
 X 400 Footwide Subarea Width
 Limits of flooding may vary from actual location on the ground
 A 1:1 Postography 10/14/88

SCALE IN FEET
 0 500 1000 1500 2000



UNITED STATES DEPARTMENT OF AGRICULTURE
 SOIL CONSERVATION SERVICE
 MATANUSKA VALLEY
 ALASKA

LEGEND
 Cottonwood Creek
 Cottonwood Subdivided Works
 Line of flooding map not shown
 Actual location of the ground

SCALE IN FEET
 0 200 400 600 800 1000

FLOOD PLAIN MANAGEMENT STUDY
COTTONWOOD CREEK

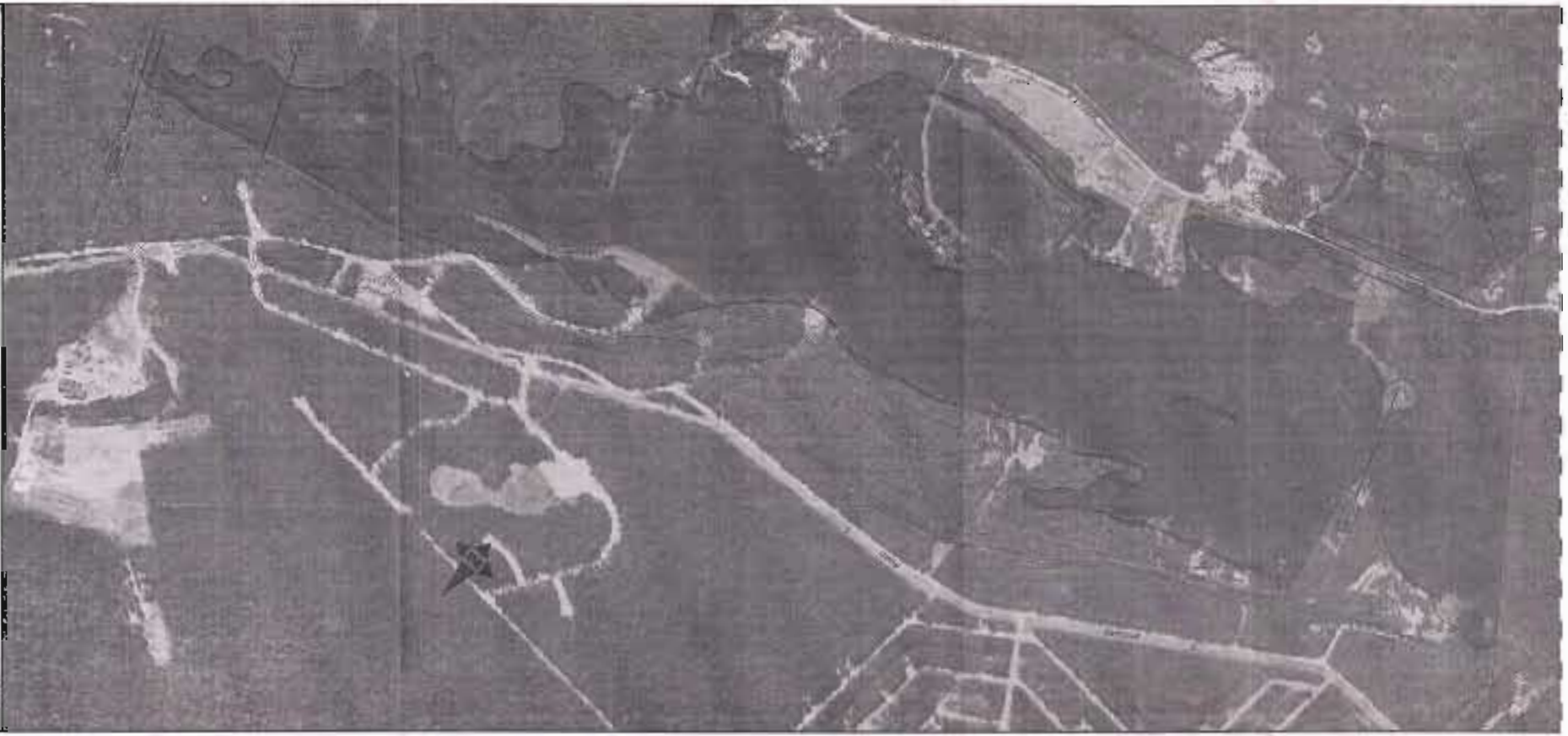

LEGEND

- Ditch 100' Year Flood
- Approximate 100 Year Flood
- Cross Section Location
- Stream Channel

- X Station Reference Mark
- Limits of flooding may vary from actual sections of the ground

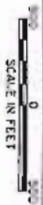

Aerial Photography 10/14/80

DRAWN 4
SHEET 2 OF 17

U.S. DEPARTMENT OF AGRICULTURE
SOIL CONSERVATION SERVICE
MATANUSKA VALLEY
ALASKA

FLOOD PLAIN MANAGEMENT STUDY
COTTONWOOD CREEK



100
 0
 100
 SCALE IN FEET

X 6-10 Elevation Reference Marks
 Lines of flooding are very from
 actual locations on the ground

LEGEND
 100 Year Flood
 Cross Section Location
 Stream Channel
 Approximate 100 Year Flood

U.S. DEPARTMENT OF AGRICULTURE
 SOIL CONSERVATION SERVICE
 MATANUSKA VALLEY
 ALASKA

FLOOD PLAIN MANAGEMENT STUDY
 COTTONWOOD CREEK



Inactive 100 Year Road
 100 Year Road
 Approximate 100 Year Flood
 100 Year Flood

JICPD
 Civil Service Location
 100 Year Flood Channel
 100 Year Flood Channel Mark
 Lines of flooding may vary from actual locations on the ground. A.S.T. Municipality 10/14/80

SCALE IN FEET
 0 500 1000

THE DEPARTMENT OF AGRICULTURE
 SOIL CONSERVATION SERVICE
 MATANUSKA VALLEY
 ALASKA

FLOOD PLAIN MANAGEMENT STUDY
 COTTONWOOD CREEK



100 Year Flood
 500 Year Flood
 1000 Year Flood
 X 400 Elevator Reference Mark
 Limits of flooding map may be actual locations on the ground
 U.S. DEPARTMENT OF AGRICULTURE
 SOIL CONSERVATION SERVICE
 MATANUSKA VALLEY
 ALASKA

SHEET 4 OF 17
 EXHIBIT 4
 FLOOD PLAIN MANAGEMENT STUDY
 COTTONWOOD CREEK

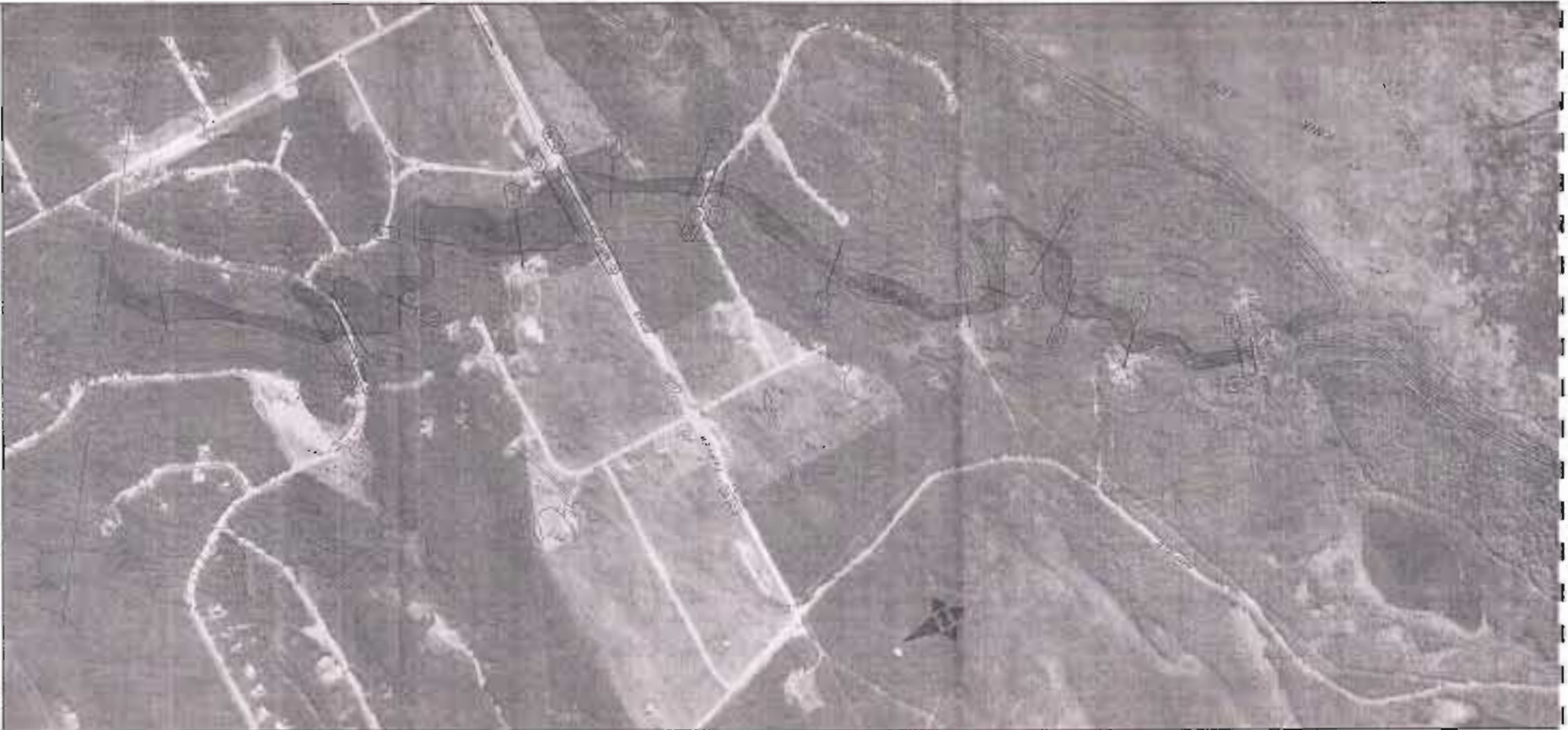

10000' Contour
 5000' Contour
 100' Contour
 50' Contour
 25' Contour
 10' Contour
 5' Contour
 1' Contour
 0' Contour
 100' Contour
 500' Contour
 1000' Contour
 2000' Contour
 3000' Contour
 4000' Contour
 5000' Contour
 6000' Contour
 7000' Contour
 8000' Contour
 9000' Contour
 10000' Contour

U.S. DEPARTMENT OF AGRICULTURE
 SOIL CONSERVATION SERVICE
 MATANUSKA VALLEY
 ALASKA

FLOOD PLAIN MANAGEMENT STUDY
 COTTONWOOD CREEK

10000' 0 1000
 SCALE IN FEET

A.P.I. PROJECT NUMBER: 2014/20

10000' 0 1000
 SCALE IN FEET

10000' 0 1000
 SCALE IN FEET

10000' 0 1000
 SCALE IN FEET

10000' 0 1000
 SCALE IN FEET

10000' 0 1000
 SCALE IN FEET

10000' 0 1000
 SCALE IN FEET

10000' 0 1000
 SCALE IN FEET

10000' 0 1000
 SCALE IN FEET

10000' 0 1000
 SCALE IN FEET

10000' 0 1000
 SCALE IN FEET

10000' 0 1000
 SCALE IN FEET

10000' 0 1000
 SCALE IN FEET

10000' 0 1000
 SCALE IN FEET

10000' 0 1000
 SCALE IN FEET

10000' 0 1000
 SCALE IN FEET

10000' 0 1000
 SCALE IN FEET

10000' 0 1000
 SCALE IN FEET

10000' 0 1000
 SCALE IN FEET

10000' 0 1000
 SCALE IN FEET

10000' 0 1000
 SCALE IN FEET

10000' 0 1000
 SCALE IN FEET

10000' 0 1000
 SCALE IN FEET

10000' 0 1000
 SCALE IN FEET

10000' 0 1000
 SCALE IN FEET

10000' 0 1000
 SCALE IN FEET

10000' 0 1000
 SCALE IN FEET

10000' 0 1000
 SCALE IN FEET

10000' 0 1000
 SCALE IN FEET

10000' 0 1000
 SCALE IN FEET

10000' 0 1000
 SCALE IN FEET

10000' 0 1000
 SCALE IN FEET

10000' 0 1000
 SCALE IN FEET

10000' 0 1000
 SCALE IN FEET

10000' 0 1000
 SCALE IN FEET

10000' 0 1000
 SCALE IN FEET

10000' 0 1000
 SCALE IN FEET

10000' 0 1000
 SCALE IN FEET

10000' 0 1000
 SCALE IN FEET

10000' 0 1000
 SCALE IN FEET

10000' 0 1000
 SCALE IN FEET

10000' 0 1000
 SCALE IN FEET

10000' 0 1000
 SCALE IN FEET



SUSTNA
RIVER

100 FT

1000 0 1000
SCALE IN FEET

- Detailed 100 Foot
- Base
- Approximate 100 Foot Flood
- Erosion Section
- Levee
- Stream Channel

X 2000 Elevation Reference Mark
Elevation of flooding may vary from
actual because of the ground

AET Photogramy 10/14/80

U.S. DEPARTMENT OF AGRICULTURE
SOIL CONSERVATION SERVICE
MATANUSKA VALLEY
ALASKA

FLOOD PLAIN MANAGEMENT STUDY

KASHWITNA RIVER

